

AGRO Kabelverschraubungen

AGRO Cable Glands

Für professionelle Kabeleinführungen.
For professional cable entries.

27



Progress® . Syntec® . EMV . Ex . Flanschwinkel . Zubehör
Progress® . Syntec® . EMC . Ex . Flanged elbows . Accessories

**AGRO**
... your quality-connection



Professionelle Lösungen von AGRO für die sichere Kabeleinführung

Progress® Kabelverschraubungen bieten ein umfangreiches Sortiment aus Kunststoff, Messing oder rostfreiem Stahl A2 / A4 und sind bewährte Helfer für die fachgerechte Kabeleinführung in Industrieanlagen. Die herausragende Kompressionstechnik sorgt für eine hohe Dichtigkeit und eine äusserst kabelschonende Zugentlastung.

Progress® Kabelverschraubungen aus Metall sind zertifiziert für Schienenfahrzeuge nach EN 45545-2 / -3.

Progress® EMV-Kabelverschraubungen aus Messing sorgen für eine niederimpedante Verbindung zwischen Schirmgeflecht und Metallgehäuse bei einer gleichzeitig sicheren Kabeleinführung.

Progress® Ex-Kabelverschraubungen aus Kunststoff oder Messing sorgen auch in explosionsgefährdeten Bereichen für eine sichere Kabeleinführung.

Syntec® Kabelverschraubungen aus Kunststoff oder Messing sind die optimale Lösung für Ihre täglichen Installations-Aufgaben. Die patentierte, einzigartige Lamellentechnik garantiert immer eine praxisgerechte Kabeleinführung, bei hervorragender Zugentlastung.

Professional solutions made by AGRO for a safe cable entry

Progress® cable glands made of synthetics, nickel-plated brass or stainless steel A2 / A4 are proven aids for professional cable entry in industrial plants. The excellent compression technology ensures tight seals and strain relief which is exceptionally easy on cables.

Progress® metal cable glands are certified for railway applications according to EN 45545-2 / -3.

Progress® EMC cable glands made of nickel-plated brass ensure a low-impedance connection between the braided shield and the metal housing while maintaining secure cable entry.

Progress® Ex cable glands made of synthetics or nickel-plated brass ensure secure cable entry even in potentially explosive environments.

Syntec® cable glands made of synthetics or nickel-plated brass are the optimal solution for your daily installation tasks. The patented, unique lamellar technology always guarantees cable entry with excellent strain relief.



Alle weiterführenden Informationen zu Produkten, Systemlösungen und Kommunikationsmedien finden Sie aktuell auf unserer Internetseite **www.agro.ch** oder in der AGRO App.

Please find additional information about products, system solutions and communication media on our website **www.agro.ch** or by means of the AGRO App.



Der einzigartige **Produktfinder**: Finden Sie die passende Kabelverschraubung durch Eingabe des Kabel-Durchmessers.

The unique **product finder**: Find the right gland quickly and easily by entering the cable diameter.

CAD-Daten in allen gängigen Formaten.

Von nahezu allen Kabelverschraubungen kann die 3D-Produktansicht eingeblendet werden. Hier bieten wir Ihnen den besonderen Service, die jeweiligen Daten in allen gängigen CAD-Formaten sich per Email zusenden zu lassen.

Die 3D-Ansicht und die Bestellmöglichkeit für die CAD-Daten können Sie über den Navigationspunkt „CAD Ansicht“ in der Produkt-Einzelansicht im Navigationsmenü unter den Produktdaten aufrufen.

CAD-data in all current formats.

For almost all cable glands, a 3D view can be displayed. 3D CAD data may be requested and will be sent via email in all current formats.

You have the possibility to display a 3D view or to order CAD data when you choose a specific item and click on the navigation bar „CAD view“. You will find this bar at the bottom of the product specifications.



Produktübersicht Product overview

	<i>Kabelverschraubungen Progress® Messing Cable glands Progress® nickel-plated brass</i>	<i>Kabelverschraubungen Progress® nickel-plated brass</i>	<i>Spezielle Kabelverschraubungen Progress® rostfreier Stahl A2 / A4 Special Messing / Special cable glands and cable entries nickel-plated brass</i>	<i>EMV Kabelverschraubungen und Kabeleinführungen EMC cable glands</i>	<i>Ex Kabelverschraubungen Progress® Messing Ex cable glands Progress® nickel-plated brass</i>	<i>Kombi-Schlauchverschraubungen Progress® Messing mit integrierter Kabelverschraubung Combination conduit brass or synthetic with integrated cable gland</i>	<i>Kabelverschraubungen Progress® Messing Synthetic cable gland</i>	<i>Kabelverschraubungen Progress® nickel-plated brass Synthetic cable glands Progress®</i>	<i>Spezielle Kabelverschraubungen Syntec® Kunststoff Kabeleinführungen Syntec® Messing, Kunststoff Special cable glands and cable entries synthetic</i>
Ausführung / Version									
Kompressionstechnik Compression technology	•	•	•	•	•	•	•	-	•
Lamellentechnik Lamellar technology	-	-	-	-	-	-	-	•	-
Gewinde / Thread									
Anschlussgewinde metrisch Entry thread metric	•	•	•	•	•	•	•	•	•
Anschlussgewinde Pg Entry thread Pg	•	•	•	•	•	•	•	•	•
Anschlussgewinde NPT Entry thread NPT	•	-	-	-	•	-	-	•	-
Anschlussgewinde Gasrohr Entry thread gas pipe	•	-	-	-	•	-	-	-	-
Kurzes Anschlussgewinde Short entry thread	•	-	•	•	•	•	-	•	•
Langes Anschlussgewinde Long entry thread	•	•	•	•	•	•	•	•	-
Dichteinsatz / Sealing insert									
für Rundkabel for round cables	•	•	•	•	•	•	•	•	•
für Flachkabel for flat cables	•	-	-	-	-	-	A	-	-
für mehrere Kabel for several cables	•	-	-	-	•	-	•	-	-
TPE/NBR-Dichteinsatz (bis 100° C) TPE/NBR sealing insert (up to 100°C)	•	•	•	•	•	•	•	•	•
FPM-Dichteinsatz (bis 200° C) FPM sealing insert (up to 200°C)	•	•	-	•	-	-	-	-	-
Spezial TPE für EN 45545 Special TPE for EN 45545	•	-	•	•	-	•	-	-	-
Technische Besonderheiten / Technical features									
Knickschutz Antikink	•	-	-	•	-	-	-	•	-
Biegeschutz Bending protection	•	-	•	-	•	-	-	-	-
Externe Zugentlastung External strain relief	•	-	•	•	•	-	-	-	-
Für Schlauchanschluss For conduit connecting	•	-	-	-	-	•	-	-	-
Material / Material									
Polyamid / Polyamide	-	-	-	-	-	-	-	•	•
Polyamid glasfaserverstärkt Polyamide fibre-glass reinforced	-	-	-	-	-	-	•	-	-
Messing vernickelt Nickel-plated brass	•	-	•	•	•	•	-	•	-
rostfreier Stahl A2 Stainless steel A2	-	•	-	-	•	-	-	-	-
rostfreier Stahl A4 Stainless steel A4	-	•	-	-	•	-	-	-	-

A = auf Anfrage / upon request

	Kabelverschraubungen Progress® Messing Cable glands Progress® nickel-plated brass		1
		16 - 57	
	Kabelverschraubungen Progress® rostfreier Stahl A2 / A4 Cable glands Progress® stainless steel A2 / A4		2
		58 - 65	
	Spezielle Kabelverschraubungen und Kabeleinführungen Messing Special cable glands and cable entries nickel-plated brass		3
		66 - 83	
	EMV Kabelverschraubungen Progress® Messing EMC cable glands Progress® nickel-plated brass		4
		84 - 103	
	Kabelverschraubungen Progress® Messing nach EN 45545 Cable glands Progress® nickel-plated brass according to EN 45545		5
		104 - 107	
	Ex Kabelverschraubungen Messing oder Kunststoff Ex cable glands nickel-plated brass or synthetic		6
		108 - 149	
	Kombi-Schlauchverschraubungen Messing mit integrierter Kabelverschraubung Combination conduit glands nickel-plated brass with integrated cable gland		7
		150 - 163	
	Kabelverschraubungen Progress® Kunststoff Synthetic cable glands Progress®		8
		164 - 175	
	Kabelverschraubungen Syntec® Messing und Kunststoff Cable glands Syntec®, nickel-plated brass and synthetics		9
		176 - 189	
	Spezielle Kabelverschraubungen und Kabeleinführungen Kunststoff Special cable glands and cable entries synthetic		10
		190 - 195	
	Zubehör zu Kabelverschraubungen Kunststoff oder Metall AGROflex Geflechschläuche und AGROtube Glasseidenschläuche Accessories for cable glands synthetic or metal AGROflex Braided sleeveings and AGROtube Braided glass fibre sleeveings		11
		196 - 238	
	Zusatzinformationen / Sonderlösungen Additional information / Customised solutions		12
		239 - 274	

Starke Marken für internationale Märkte.
Strong brands for international markets.



AGRO, Hunzenschwil, Schweiz
AGRO, Hunzenschwil, Switzerland



Hauptsitz KAISER, Schalksmühle, Sauerland
KAISER headquarters, Schalksmühle, Germany



HELIA, Bornem, Belgien
HELIA, Bornem, Belgium

Seit 1953, also seit 60 Jahren, entwickelt und fertigt AGRO vom Standort Hunzenschwil (Schweiz) aus qualitativ hochwertige Produkte und Systeme zur Einführung und Verlegung von Kabeln für die Maschinenindustrie, für den Anlagen- und Apparatebau sowie für die professionelle Elektroinstallation in Gebäuden aller Art. AGRO gehört seit 2002 zur KAISER-Unternehmensfamilie. Die Synergien, die wir aus den Unternehmen ziehen, kommen Ihnen national und international zu Gute.

Gemeinsam Zukunft gestalten.

Die Marken KAISER, AGRO und HELIA bieten Ihnen immer die marktgerechte Installationslösung und unterstützen Sie so effektiv bei Ihren täglichen Aufgaben. Durch die kontinuierliche, zukunftsorientierte Produktinnovation sind Sie mit den drei starken Marken stets auf dem neuesten Stand der Technik – heute und morgen.

Since 1953, in other words for 60 years, AGRO has been developing and manufacturing high-quality products and systems for the installation and entry of cables in the machine industry, as well as for plant engineering and construction, equipment manufacturing and professional electrical installation in buildings of all kinds. Headquartered in Hunzenschwil, Switzerland, AGRO has been part of the KAISER group since 2002. Our customers benefit from the resulting synergies both in the domestic market and abroad.

Together – shaping the future.

The KAISER, AGRO and HELIA brands consistently offer you installation solutions which meet the needs of the market and thereby effectively support you in your daily work. Through their continuous future-oriented product innovations, these three strong brands provide assurance that you are always at the state of the art - today and tomorrow.



KAISER GROUP

 KAISER  AGRO  HELIA



Die KAISER Gruppe, ein Familienunternehmen in der dritten Generation, setzt seit jeher auf Fortschritt und Tradition. Als Innovationsführer im Bereich von Elektroinstallationsprodukten und Kabeleinführungen wollen wir für unsere Kunden mit starken Ideen und Lösungen der Branche stets einen Schritt voraus sein. Qualifizierte, erfahrene Mitarbeiterinnen und Mitarbeiter sind dabei der Garant für die hohe Qualität von KAISER. Unsere Partner im Fachhandwerk und -handel sowie in der Industrie können auf unsere Innovationskraft für die Märkte von heute und morgen vertrauen. Dies gilt auch für den kundennahen Service und die schnelle Lieferfähigkeit, die eine starke Elektromarke auszeichnen.

The KAISER Group, a family-run company in its third generation, has always placed emphasis on progress and tradition. As a leading innovator in the area of electrical installation products and cable entries, our goal is to continuously be a step ahead for the benefit of our customers through powerful ideas and solutions in this sector. In this regard, our qualified, experienced employees are the guarantee of the high quality you can expect from KAISER. Our partners in the trades and professional retailers as well as throughout industry can place their trust in our innovative power, which allows us to address the markets of today and tomorrow. The same is also true for our customer-oriented service and fast delivery times, aspects which mark a truly strong brand of electrical products.

Ulrich Kaiser
KAISER GmbH & Co. KG

Burkard Kaiser
Geschäftsführer / CEO
KAISER GmbH & Co. KG



Im Verkehrswesen kommt es vor allem auf den sicheren Halt der Zuleitung an. Die in der Bahntechnik verwendeten Progress®-Kabelverschraubungen lockern sich trotz hoher Rüttelbelastungen nicht. Daher ermöglichen sie eine einwandfreie Strom- und Signalübertragung im gesamten Schienenfahrzeug. Neu sind zertifizierte Dichteinsätze für Schienenfahrzeuge nach EN 45545 verfügbar.

For **transportation**, a secure grip on the feed line is vital. The Progress® cable glands used in railway technology do not slacken, despite high vibrating loads. This results in perfect power and signal transmission throughout the train. For rail applications according to EN 45545, you can now get certified sealing inserts.

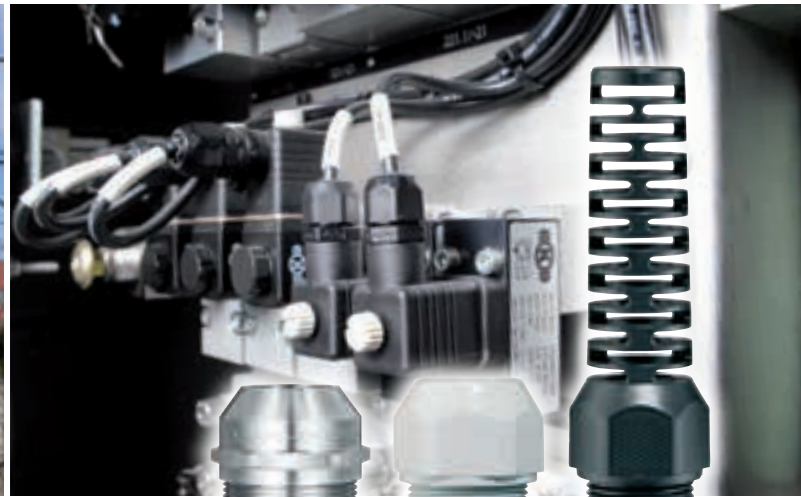

Messing oder Kunststoff Syntec® Kabelverschraubungen sind die ideale Lösung für vielfältige **tägliche Aufgaben**. Die einzigartige patentierte Lamellentechnik klemmt das Kabel auf schonende Art und Weise und garantiert eine sichere Kabeleinführung mit hervorragender Zugentlastung

Nickel-plated brass or synthetic Syntec® cable glands represent the optimal solution for a wide range of **daily tasks**. The patented, unique lamellar technology clamps the cable smoothly and guarantees practical cable entry with outstanding strain relief.



Durch Staub und Abgase entsteht ein beträchtliches Mass an chemischer Belastung in **Tunneln**. Diese erfordert den Einsatz von rostfreien und säurebeständigen Kabelverschraubungen aus Stahl A4 mit FPM Dichteinsatz. Kabeldurchmesser von 2.0 mm bis 52.0 mm können sicher eingeführt werden.

Dust and exhaust emissions cause high levels of chemical pollution in **tunnels**. This calls for the use of stainless and acid-resistant stainless steel A4 cable glands with FPM sealing insert. Cable diameters from 2.0 mm to 52.0 mm are used here on a daily basis.



Kabelverschraubungen für den Einsatz im **Schiffsbau** müssen spezifische Anforderungen erfüllen. Ein DNV-Zertifikat bescheinigt die Erfüllung dieser Anforderungen. Alle metrischen AGRO Kabelverschraubungen sind DNV zertifiziert. Unabhängig von ihrem Gewinde sind zusätzlich alle AGRO Ex Kabelverschraubungen für den Einsatz im Schiffsbau zugelassen.

For **marine industry**, cable glands have to meet specific requirements. DNV certification grants the fulfillment of such requirements. All metric AGRO cable glands are DNV certified. Additionally all AGRO Ex cable glands are approved, irrespective of their entry thread.



Elektronisch gesteuerte **Umspannstationen** funktionieren so lange reibungslos, wie keine Signale durch Störströme verfälscht werden. Der konzentrische Schirmabgriff der Progress® EMV Kabelverschraubungen führt Störströme auf Masse und garantiert kleinste Transferimpedanzen.

Electronically-controlled **substations** operate in a smooth way as long as parasitic currents do not affect their function. The concentric screened tap connection of Progress® EMC cable glands discharges interference currents to earth and thus grants lowest transfer impedance.



In der **Lebensmittelindustrie** kommen Keim abtötende Substanzen zum Einsatz. Diese Substanzen garantieren auf der einen Seite die Hygiene und stellen auf der anderen Seite besondere Anforderungen an die eingesetzten Materialien der Produktionsmittel. AGRO Kabelverschraubungen aus rostfreiem Stahl A2 halten der erhöhten Beanspruchung problemlos stand. Die Kabelverschraubungen der Serie Progress® ultraFLAT sind nach EHEDG zertifiziert.

In **food industries**, anti-bacterial substances guarantee a high level of safety. These chemical agents, however, also place a considerable burden on production facilities. AGRO cable glands made of stainless steel A2 reliably meet these daily challenges. The cable glands of the Progress® ultraFLAT series are EHEDG certified.



Raffinerien und Produktionsanlagen der chemischen Industrie mit explosionsgefährdeten Bereichen stellen besondere Anforderungen an die elektrische Installation. AGRO bietet zertifizierte Kabelverschraubungen für druckfeste Kapselung Ex d IIC, für erhöhte Sicherheit Ex e II und für Eigensicherheit Ex i II an.

Refineries and production facilities in the chemical industry with potentially explosive areas make specific demands on electrical installations. AGRO offers special cable glands and accessories for "flameproof enclosure Ex d IIC", "increased safety Ex e II" and "intrinsic safety Ex i II" — protection types that have been standardised throughout Europe.



Bei der Realisierung von **Windkraftanlagen** bietet die Progress®-Baureihe eine kabelschonende Zugentlastung mit hoher Verdreh-sicherheit. Dabei spielt es keine Rolle, ob es sich um Rundkabel oder Flachleitungen handelt.

For the implementation of **wind turbine generators**, the Progress® range offers cable protecting strain relief with high distortion protection. This applies to both round and flat cables.



Kabelverschraubungen Progress® in Metall.

Zertifiziert für Schienenfahrzeuge nach EN 45545.



AGRO Progress® Kabelverschraubungen aus Metall können bedenkenlos für alle Anwendungen und Anordnungen im Schienenfahrzeugbereich eingesetzt werden. Die herausragende Progress® Kompressionstechnik sorgt für eine hohe Dichtigkeit und eine äußerst kabelschonende Zugentlastung auch bei dynamischen Anwendungen. Standard- und EMV-Kabelverschraubungen mit dem entsprechenden Zubehör bilden das Basissortiment.

Beste Resultate nach EN 45545-2

Die Dichteinsätze der Progress® Kabelverschraubungen sind aus einem speziellen TPE gefertigt und im anspruchsvollsten **Hazard Level 3** zertifiziert. Die geforderten Werte für Hazard Level 3 wurden sowohl im Aussen- als auch im Innenbereich deutlich übertroffen. AGRO Progress® Kabelverschraubungen aus Metall übertreffen die Vorgaben der EN 45545-3 bei weitem und erreichen die sehr hohe Feuerwiderstandsklasse **E30**.

Cable gland Progress® made of metal.

Certified for rolling stock, according to EN 45545.

AGRO Progress® metal cable glands can be used with confidence for any rolling stock application, in any arrangement, as has been recently certified.

The outstanding Progress® compression technology ensures tight seals and offers cables exceptional damage-preventing strain relief, even in dynamic applications. A comprehensive range of standard and EMC cable glands and accessories offers a solution for almost any application. Where the need arises, AGRO also delivers certified solutions according to customer requirements.

Best results in testing according to EN 45545-2

The sealing inserts of Progress® cable glands are made from a special TPE and certified to the demanding **Hazard Level 3**. The stipulated values for Hazard Level 3 were exceeded, for both indoor and outdoor areas. AGRO Progress® metal cable glands easily exceed the requirements of EN 45545-3 and satisfy the very high demands of fire resistance class **E30**.



Kabelverschraubungen Progress® ultraFLAT.

Die Idealbesetzung für Reinraum und Lebensmittelindustrie.



Die ultraflache Konstruktion der Kabelverschraubung Progress® ultraFLAT bietet wenig Oberfläche, an der sich Verschmutzungen ablagern können - die gute Reinigbarkeit für den Einsatz in Reinräumen oder der Lebensmittelindustrie wird durch das EHEDG-Zertifikat bestätigt. Ausführungen in Edelstahl und Dichteinsätze für Hochtemperaturen oder mit FDA Konformität sprechen für diese Wahl.

Cable gland Progress® ultraFLAT.

The ideal choice for cleanrooms and food industry

The ultra flat construction of the Progress® ultraFLAT offers very little surface for contamination - the good cleanability which is crucial for cleanroom and food applications is documented by a certificate of the EHEDG. Executions in stainless steel and with high-temperature or FDA cleared sealing inserts are further arguments for this choice.



Verschlussbolzen für Kabelverschraubungen mit Multi-Dichteinsatz.

Verschlussbolzen zum sicheren Verschliessen von nicht belegten Bohrungen in Multi-Kabelverschraubungen oder zum Verschliessen von einfachen Durchführungen in Standard-Kabelverschraubungen. Idealer Staub- oder Transportschutz.

Locking pins for cable glands with multi-duct sealing insert.

Locking pins for safe closure of unassigned boreholes in standard cable glands with ducts for several cables or to close single feeds of standard cable glands. Ideal dust or transport protection.

S. 89

Kabelverschraubung Progress® EMV easyCONNECT Multi.

EMV-Kabelverschraubung für mehrere Kabel.

Die Progress® easyCONNECT Multi ist die erste Kabelverschraubung, die das Einführen von mehreren geschirmten Kabeln in ein Gehäuse erlaubt - und dies mit kraftvollem und sicherem Schirmabgriff.

- Die Montage ist einfach, sicher und schnell
- Die Kontaktfeder schont die Schirmgeflechte
- Der Schirmkontakt erfolgt durch schonende und doch kraftvolle Klemmung und gewährleistet hervorragende Ableitwerte
- Die Kabel bleiben während des Montageprozesses dreh-, schieb- und demontierbar

Cable gland Progress® EMC easyCONNECT Multi.

EMC cable gland for several cables.

The Progress® easyCONNECT Multi is the first cable gland that allows for the entry of several shielded cables into a housing - at any moment granting a strong and safe tap connection.

- Fast, safe and easy assembly
- The contact spring is easy on the cable shields
- The tap connection is assured by a gentle but strong way of clamping and results in an excellent conductivity values
- Cables may be rotated, moved and removed during the assembly



S. 198

Druckausgleichselemente.

Mit Membrane oder Sinterfilter.

Um Druckdifferenzen, hohe Luftfeuchtigkeit und Kondenswasserbildung im Gehäuse zu verhindern, müssen ein stetiger Druckausgleich und Luftwechsel stattfinden. Der Einbau von AGRO Druckausgleichselementen in Elektro- und Elektronikgehäusen bewirkt einen effizienten Druckausgleich und sorgt für eine konstante Belüftung und bei Bedarf auch für Entwässerung.

Druckausgleichselemente sind mit Membrane und Sinterfilter oder mit Sieb als Entässerungselement in den Ausführungen **Messing vernickelt** oder **Kunststoff** erhältlich.

Pressure balance elements.

With membrane or sinter filter.

To prevent pressure differences, high humidity and condensation of water in the housing, constant balancing of pressure and exchange of air is needed. The use of AGRO pressure balance elements in electrical and electronics housings allows efficient pressure balance and ventilation, and if necessary, drainage.

Pressure balance elements are available with membrane and sinter filter or with mesh to function as drainage element. We offer versions in **nickel-plated brass** or **synthetic material**.



S. 249

AGRO Kundenspezifische Lösungen.

Wir machens möglich.

Als kompetenter Partner bieten wir nicht nur ein breites Standard-Sortiment sondern entwickeln auch kundenspezifische Lösungen, passend für individuelle Anwendungsfälle.

Schon in der Entwicklungsphase beraten wir Sie bei der Umsetzung Ihrer Projekte. Dadurch ist es möglich, die hohen Anforderungen Ihrer Produkte an Funktionalität und Design unter wirtschaftlichen Gesichtspunkten gemeinsam zu gestalten.

- Viele Lösungen aus unserem Progress® Baukasten sind schnell und einfach realisierbar
- Individuelle Systemlösungen für spezielle Anforderungen
- Umfangreiche Beratung und Bemusterung bereits in der Entwicklungsphase

AGRO customised solutions.

We make it possible.

As your competent partner, we not only offer a wide range of standard products, but also develop customised solutions to accommodate your specific needs.

Already in the development phase, we will be pleased to provide advice on the implementation of your projects. This will enable us to jointly define the high requirements of your products in terms of functionality and design from an economic perspective.

- Many solutions from our Progress® construction set can be implemented quickly and easily
- Individual system solutions for special requirements
- Comprehensive advice and provision of samples as early as the development phase



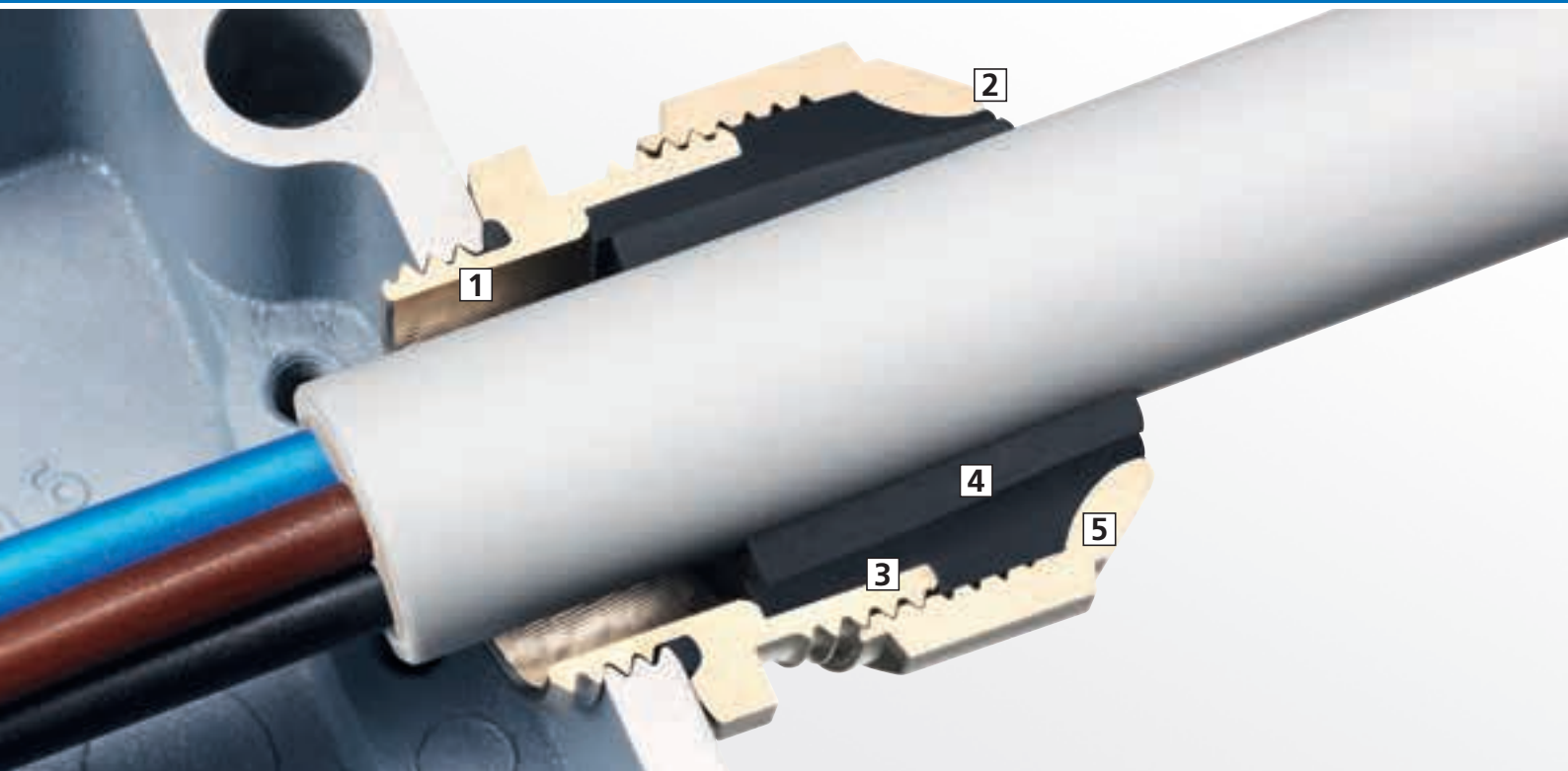

AGRO Kabelverschraubungen Progress® Messing vernickelt sind bewährte Helfer für die fachgerechte Kabeleinführung in Industrieanlagen. Durch die richtige Wahl mit dem passenden Dichteinsatz sind sie überall einsetzbar. Die herausragende Kompressionstechnik sorgt für eine hohe Dichtigkeit und eine äusserst kabelschonende Zugentlastung auch bei dynamischen Belastungen.

AGRO Progress® Kabelverschraubungen aus Metall mit Dichteinsätzen aus einem speziellen TPE sind zertifiziert nach EN 45545 und können bedenkenlos für alle Anwendungen und Anordnungen im Schienenfahrzeugbau eingesetzt werden.

1 Kurze, lange oder Spezial-Anschlussgewinde

Kabelverschraubungen Progress® mit kurzem oder langem Anschlussgewinde in metrischer, Pg-, Gasrohr oder NPT-Ausführung können bei vorhandenem Öffnungsgewinde oder mit Gegenmutter verwendet werden.

2 Sichtbare Sicherheit

Der kleine Wulst des Dichteinsatzes bestätigt das richtige Anzugsmoment.

3 Hoher Verdrehschutz

Die im Unterteil integrierte Längsrandrierung sorgt über den Dichteinsatz für eine hohe Verdrehsicherheit.

4 Grosse Flexibilität

Zweiteilige Dichteinsätze können in Sekundenschnelle vor Ort auf den vorhandenen Kabeldurchmesser angepasst werden.

5 Garantierte Dichtigkeit

Auf den Dichteinsatz abgestimmte Innenkonturen sorgen für eine zielgerichtete Verformung des Dichteinsatzes und garantieren somit dessen perfekte Abdichtung. Die Schutzart IP 68 bis 10 bar sowie IP 69K ermöglichen eine breite Anwendung.

Cable glands Progress® nickel-plated brass are tried and tested aids for correct cable entry in industrial equipment. If the correct choice with the right sealing insert, these glands can be used anywhere. The outstanding compression technology for use everywhere guarantees an effective seal and excellent cable-protecting strain relief, also by vibrations.

AGRO Progress® metal cable glands equipped with sealing inserts made of a special TPE are certified according to EN 45545 and can be used with confidence for any rolling stock application.

1 Short, long or special entry thread

Cable glands Progress® with short or long entry thread designed as metric, Pg, imperial or NPT can be used with existing opening threads or with a counter nut.

2 Visible safety

The small bead in the sealing insert confirms the correct tightening torque.

3 High distortion protection

The integrated retaining grooves in the lower part and in the sealing insert grant against twisting.

4 Great flexibility

It only takes a few seconds to adapt the two-part sealing inserts on site to the existing cable diameters.

5 Guaranteed seal

Inner contours matched to the sealing insert ensure a targeted deformation of the insert and thus guarantee its tightness in compliance with protection class IP 68 up to 10 bar and IP 69K for a wide range of applications.

Progress®-Bauteile können frei kombiniert werden
Progress® components are freely combineable

Oberteil / Upper part



Standard-Druckmutter
Standard compression nut



Knickschutz
Antikink spring



Trompete
Trumpet



Klemmbacken und Trompete
Clamps with Trumpet



Klemmbacken
Clamps



Schlauchverschraubungen
Conduit glands

Dichteinsatz / Sealing inserts



Kurzer ein- oder zweiteiliger Dichteinsatz in NBR, TPE, Spezial TPE nach EN 45545 oder FPM (temperaturbeständig) / Short one or two-piece sealing insert made of NBR, TPE, special TPE acc. EN 45545 or FPM (heat resistant)

Langer durchgehend isolierender Dichteinsatz in NBR, TPE, Spezial TPE nach EN 45545 ein- oder zweiteilig / Long one or two-piece overall length insulating sealing insert made of NBR or TPE special TPE acc. EN 45545

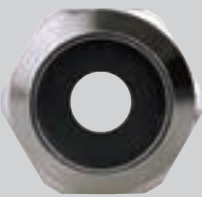

mit Standard-Bohrungen
with standard holes



mit individuellen Öffnungen
with customised holes



Unterteil / Lower Part



mit kurzem Anschlussgewinde
with short entry thread

- metrisch / metric
- Pg / Pg
- NPT / NPT
- Gasrohr / gaspipe



mit langem Anschlussgewinde
with long entry thread

- metrisch / metric
- Pg / Pg
- NPT / NPT
- Gasrohr / gaspipe



Progress® Messing
Progress® nickel-plated brass

Standard
Standard

für hohe Temperaturen
for high temperatures

für mehrere Kabel
for installation of multiple cables

mit Dichteinsatz
with sealing insert without drilled hole

für spezielle Kabel
for special cables

mit Knickschutzfeder
with special entry thread

mit Knickschutzfeder
with antikink spring

mit Klemmbacken
with clamps

mit Trompete
with trumpet

mit Trompete und Klemmbacken
with trumpet and clamps

Ausführung / Version											
Kompressionstechnik Compression technology		•	•	•	•	•	•	•	•	•	•
Gewinde / Thread											
Anschlussgewinde metrisch Entry thread metric		•	•	•	•	•	•	•	•	•	•
Anschlussgewinde Pg Entry thread Pg		•	•	•	•	•	•	•	•	•	•
Anschlussgewinde NPT Entry thread NPT		•	-	-	-	-	-	-	-	-	-
Anschlussgewinde Gasrohr Entry thread gas pipe		•	-	-	-	-	-	-	-	-	-
Kurzes Anschlussgewinde (Standard) Short entry thread (standard)		•	•	•	•	•	•	•	•	•	•
Langes Anschlussgewinde Long entry thread		•	•	•	•	•	-	•	•	•	•
Sondergewinde (extra lang, Innengewinde) Special thread (extra long, internal thread)		•	-	-	-	-	•	-	-	-	-
Dichteinsatz / Sealing insert											
für Rundkabel for round cables		•	•	•	-	-	•	•	•	•	•
für Flachkabel for flat cables		•	-	-	-	•	-	-	-	-	-
für mehrere Kabel (Multi-Dichteinsatz) for multi sealing insert		•	-	•	-	-	-	-	-	-	-
Vollgummi-Dichteinsatz Solid rubber sealing insert		•	•	-	•	-	-	-	-	-	-
einteiliger Dichteinsatz One-piece sealing insert		•	•	•	•	•	-	•	•	-	-
zweiteiliger Dichteinsatz Two-piece sealing insert		•	•	-	-	-	•	•	•	•	•
Spezial TPE nach EN 45545 Special TPE acc. to EN 45545		•	-	•	•	•	•	•	•	•	•
Technische Besonderheiten / Technical features											
Vibrationsschutz Vibration resistance		•	•	•	•	•	•	•	•	•	•
Material / Material											
Messing vernickelt Nickel-plated brass		•	•	•	•	•	•	•	•	•	•



<p>Kabelverschraubungen Progress® Messing Cable glands Progress® nickel-plated brass</p>		<p>16 - 29</p>	<p>1</p>
<p>Kabelverschraubungen Progress® Messing für hohe Temperaturen Cable glands Progress® nickel-plated brass for high temperature applications</p>		<p>30 - 33</p>	<p>2</p>
<p>Kabelverschraubungen Progress® Messing für mehrere Kabel Cable glands Progress® nickel-plated brass for installation of multiple cables</p>		<p>34 - 37</p>	<p>3</p>
<p>Kabelverschraubungen Progress® Messing mit Dichteinsatz ohne Bohrung Cable glands Progress® nickel-plated brass with sealing insert without drilled hole</p>		<p>38 - 39</p>	<p>4</p>
<p>Kabelverschraubungen Progress® Messing für spezielle Kabel Cable glands Progress® nickel-plated brass for special cables</p>		<p>40 - 42</p>	<p>5</p>
<p>Kabelverschraubungen Progress® Messing mit speziellem Anschlussgewinde Cable glands Progress® nickel-plated brass with special entry thread</p>		<p>43 - 44</p>	<p>6</p>
<p>Kabelverschraubungen Progress® Messing mit Knickschutzfeder Cable glands Progress® nickel-plated brass with antikink spring</p>		<p>45 - 47</p>	<p>7</p>
<p>Kabelverschraubungen Progress® Messing mit Klemmbacken Cable glands Progress® nickel-plated brass with clamps</p>		<p>48 - 53</p>	<p>8</p>
<p>Kabelverschraubungen Progress® Messing mit Trompete Cable glands Progress® nickel-plated brass with trumpet</p>		<p>54 - 55</p>	<p>10</p>
<p>Kabelverschraubungen Progress® Messing mit Trompete und Klemmbacken Cable glands Progress® nickel-plated brass with trumpet and clamps</p>		<p>56 - 57</p>	<p>11</p>

Kabelverschraubungen Progress® Messing

Cable glands Progress® nickel-plated brass

Kurzes Anschlussgewinde metrisch | Short entry thread metric

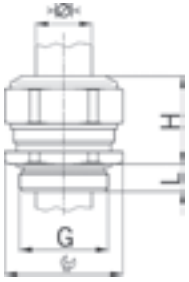

Material: Messing vernickelt
 Dichtung: TPE
 O-Ring : NBR
 Zugentlastung: Ausführung A
 Einsatztemperatur: -40°C / +100°C
 Schutzart: IP 68 (bis 10 bar)
 Weitere Schutzart: IP 69K

Material: Nickel-plated brass
 Seal: TPE
 O-ring : NBR
 Strain relief: Version A
 Temperature range: -40°C / +100°C
 Protection class: IP 68 (up to 10 bar)
 Further protection: IP 69K



Progress MS

Einteiliger Dichteinsatz
 durchgehend isolierend

One-piece sealing insert
 overall length insulated



G	> Ø < min mm	> Ø < max mm	IC	H mm	L mm	i info	Art.-Nr. Art. No.	
M6x1.0	2.0	2.5	8	12	5	1	1060.06.025	50
M6x1.0	2.5	3.0	8	12	5	1	1060.06.030	50
M8x1.25	2.5	3.0	11	14	5	1	1060.08.030	50
M8x1.25	3.0	4.0	11	14	5	1	1060.08.040	50
M10x1.5	3.0	4.0	13	15	5	1	1060.10.040	50
M10x1.5	4.0	6.0	13	15	5	1	1060.10.060	50
M12x1.5	3.5	5.0	15	17	5	-	1060.12.050	50
M12x1.5	5.0	6.5	15	17	5	-	1060.12.065	50
M12x1.5	6.5	7.5	15	17	5	-	1060.12.075	50
M16x1.5	4.5	6.0	18	20	5	-	1060.17.060	50
M16x1.5	6.0	8.0	18	20	5	-	1060.17.080	50
M16x1.5	8.0	10.5	18	22	5	-	1060.17.105	50
M20x1.5	6.0	8.0	24	21	6	-	1060.20.080	50
M20x1.5	8.0	11.0	24	21	6	-	1060.20.110	50
M20x1.5	11.0	14.5	24	23	6	-	1060.20.145	50
M25x1.5	9.5	12.5	30	25	7	-	1060.25.125	25
M25x1.5	12.5	16.0	30	25	7	-	1060.25.160	25
M25x1.5	16.0	19.0	30	28	7	-	1060.25.190	25
M32x1.5	17.0	21.0	36	28	8	-	1060.32.210	25
M32x1.5	21.0	25.5	36	28	8	-	1060.32.255	25
M40x1.5	24.0	28.5	46	31	8	-	1060.40.285	10
M40x1.5	28.5	33.0	46	31	8	-	1060.40.330	10
M50x1.5	33.0	37.0	55	34	9	-	1060.50.370	10
M50x1.5	37.0	42.0	55	34	9	-	1060.50.420	10
M63x1.5	40.0	46.0	70	37	10	-	1060.63.460	5
M63x1.5	46.0	52.0	70	37	10	-	1060.63.520	5
M75x1.5	50.0	56.0	80	38	11	-	1060.75.560	1
M75x1.5	56.0	63.0	80	38	11	-	1060.75.630	1

1 = Metrisches Regelgewinde

1 = Metric coarse-pitch thread

Erhältlich mit Dichteinsatz gemäss EN 45545. Bei Anfragen oder Bestellung bitte ein F vor die Artikelnummer setzen.

Available with sealing inserts conformity with EN 45545. When placing an inquiry, prefix the article number by the capital F.

Progress MS

Zweiteiliger Dichteinsatz
 durchgehend isolierend

Two-piece sealing insert
 overall length insulated



G	> Ø < min mm	> Ø < max mm	IC	H mm	L mm	Art.-Nr. Art. No.	
M16x1.5	6.0	10.5	18	22	5	1060.17	50
M20x1.5	8.0	14.5	24	23	6	1060.20	50
M25x1.5	12.5	19.0	30	28	7	1060.25	25
M32x1.5	17.0	25.5	36	28	8	1060.32	25
M40x1.5	24.0	33.0	46	31	8	1060.40	10
M50x1.5	33.0	42.0	55	34	9	1060.50	10
M63x1.5	40.0	52.0	70	37	10	1060.63	5
M75x1.5	50.0	63.0	80	38	11	1060.75	1

Erhältlich mit Dichteinsatz gemäss EN 45545. Bei Anfragen oder Bestellung bitte ein F vor die Artikelnummer setzen.

Available with sealing inserts conformity with EN 45545. When placing an inquiry, prefix the article number by the capital F.

Kabelverschraubungen Progress® Messing

Cable glands Progress® nickel-plated brass

Kurzes Anschlussgewinde metrisch | Short entry thread metric

Material: Messing vernickelt
 Dichtung: TPE / NBR
 O-Ring : NBR
 Zugentlastung: Ausführung A
 Einsatztemperatur: -40°C / +100°C
 Schutzart: IP 68 (bis 10 bar)
 Weitere Schutzart: IP 69K

Material: Nickel-plated brass
 Seal: TPE / NBR
 O-ring : NBR
 Strain relief: Version A
 Temperature range: -40°C / +100°C
 Protection class: IP 68 (up to 10 bar)
 Further protection: IP 69K

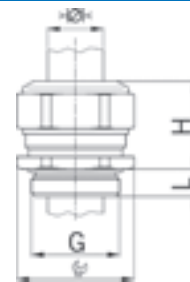

Progress MS



Einteiliger Dichteinsatz
 nicht durchgehend isolierend

One-piece sealing insert
 not overall length insulated

G	>Ø< min mm	>Ø< max mm		H mm	L mm	i info	Art.-Nr. Art. No.	
M6x1.0	2.0	2.5	8	12	5	1	1000.06.025	50
M6x1.0	2.5	3.0	8	12	5	1	1000.06.030	50
M6x1.0	3.0	3.5	8	12	5	1	1000.06.035	50
M8x1.25	2.5	3.5	11	14	5	1	1000.08.035	50
M8x1.25	3.5	5.0	11	14	5	1	1000.08.050	50
M10x1.5	3.0	4.0	13	15	5	1	1000.10.040	50
M10x1.5	4.0	6.0	13	15	5	1	1000.10.060	50
M12x1.5	3.5	5.0	15	17	5	-	1000.12.050	50
M12x1.5	5.0	6.5	15	17	5	-	1000.12.065	50
M12x1.5	6.5	8.0	15	17	5	-	1000.12.080	50
M16x1.5	3.5	4.5	18	20	5	-	1000.17.045	50
M16x1.5	4.5	6.0	18	20	5	-	1000.17.060	50
M16x1.5	6.0	8.0	18	20	5	-	1000.17.080	50
M16x1.5	8.0	10.5	18	22	5	-	1000.17.105	50
M20x1.5	6.0	8.0	24	21	6	-	1000.20.080	50
M20x1.5	8.0	11.0	24	21	6	-	1000.20.110	50
M20x1.5	11.0	15.0	24	23	6	-	1000.20.150	50
M25x1.5	9.5	12.5	30	25	7	-	1000.25.125	25
M25x1.5	12.5	16.0	30	27	7	-	1000.25.160	25
M25x1.5	16.0	20.5	30	28	7	-	1000.25.205	25
M32x1.5	14.0	17.0	36	28	8	-	1000.32.170	25
M32x1.5	17.0	21.0	36	28	8	-	1000.32.210	25
M32x1.5	21.0	25.5	36	28	8	-	1000.32.255	25
M40x1.5	20.0	24.0	46	31	8	-	1000.40.240	10
M40x1.5	24.0	28.5	46	31	8	-	1000.40.285	10
M40x1.5	28.5	33.0	46	31	8	-	1000.40.330	10
M50x1.5	29.0	33.0	55	34	9	-	1000.50.330	10
M50x1.5	33.0	37.0	55	34	9	-	1000.50.370	10
M50x1.5	37.0	42.0	55	34	9	-	1000.50.420	10
M63x1.5	35.0	40.0	70	37	10	-	1000.63.400	5
M63x1.5	40.0	46.0	70	37	10	-	1000.63.460	5
M63x1.5	46.0	52.0	70	37	10	-	1000.63.520	5
M75x1.5	45.0	50.0	80	38	11	-	1000.75.500	1
M75x1.5	50.0	56.0	80	38	11	-	1000.75.560	1
M75x1.5	56.0	63.0	80	38	11	-	1000.75.630	1
M85x2.0	63.0	70.0	95	41	18	-	1000.85.700	1
M95x2.0	68.0	75.0	110	51	20	-	1000.95.750	1
M95x2.0	73.0	80.0	110	51	20	-	1000.95.800	1
M100x3.0	78.0	85.0	115	51	22	-	1000.100.850	1
M105x3.0	83.0	90.0	120	52	22	-	1000.105.900	1
M115x3.0	88.0	95.0	125	52	22	-	1000.115.950	1



1 = Metrisches Regelgewinde

1 = Metric coarse-pitch thread

Erhältlich mit Dichteinsatz gemäss EN 45545. Bei Anfragen oder Bestellung bitte ein F vor die Artikelnummer setzen.

Available with sealing inserts conformity with EN 45545. When placing an inquiry, prefix the article number by the capital F.

Kabelverschraubungen Progress® Messing

Cable glands Progress® nickel-plated brass

Kurzes Anschlussgewinde metrisch | Short entry thread metric

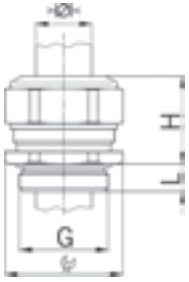

Material: Messing vernickelt
 Dichtung: TPE
 O-Ring : NBR
 Zugentlastung: Ausführung A
 Einsatztemperatur: -40°C / +100°C
 Schutzart: IP 68 (bis 10 bar)
 Weitere Schutzart: IP 69K

Material: Nickel-plated brass
 Seal: TPE
 O-ring : NBR
 Strain relief: Version A
 Temperature range: -40°C / +100°C
 Protection class: IP 68 (up to 10 bar)
 Further protection: IP 69K

Progress MS



Zweiteiliger Dichteinsatz
 nicht durchgehend isolierend

Two-piece sealing insert
 not overall length insulated



G	> Ø < min mm	> Ø < max mm	IP	H mm	L mm	Art.-Nr. Art. No.	
M16x1.5	6.0	10.5	18	22	5	1000.17	50
M20x1.5	8.0	15.0	24	23	6	1000.20	50
M25x1.5	12.5	20.5	30	28	7	1000.25	25
M32x1.5	17.0	25.5	36	28	8	1000.32	25
M40x1.5	24.0	33.0	46	31	8	1000.40	10
M50x1.5	33.0	42.0	55	34	9	1000.50	10
M63x1.5	40.0	52.0	70	37	10	1000.63	5
M75x1.5	50.0	63.0	80	38	11	1000.75	1

Erhältlich mit Dichteinsatz gemäss EN 45545. Bei Anfragen oder Bestellung bitte ein F vor die Artikelnummer setzen.

Available with sealing inserts conformity with EN 45545. When placing an inquiry, prefix the article number by the capital F.

Kabelverschraubungen Progress® Messing

Cable glands Progress® nickel-plated brass

Langes Anschlussgewinde metrisch | Long entry thread metric

Material: Messing vernickelt
 Dichtung: TPE
 O-Ring : NBR
 Zugentlastung: Ausführung A
 Einsatztemperatur: -40°C / +100°C
 Schutzart: IP 68 (bis 10 bar)
 Weitere Schutzart: IP 69K

Material: Nickel-plated brass
 Seal: TPE
 O-ring : NBR
 Strain relief: Version A
 Temperature range: -40°C / +100°C
 Protection class: IP 68 (up to 10 bar)
 Further protection: IP 69K

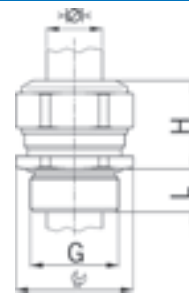

Progress MS



Einteiliger Dichteinsatz
 durchgehend isolierend

One-piece sealing insert
 overall length insulated

G	> Ø < min mm	> Ø < max mm	IP	H mm	L mm	i info	Art.-Nr. Art. No.	
M6x1.0	2.0	2.5	8	12	8	1	1160.06.025	50
M6x1.0	2.5	3.0	8	12	8	1	1160.06.030	50
M8x1.25	2.5	3.0	11	14	10	1	1160.08.030	50
M8x1.25	3.0	4.0	11	14	10	1	1160.08.040	50
M10x1.5	3.0	4.0	13	15	10	1	1160.10.040	50
M10x1.5	4.0	6.0	13	15	10	1	1160.10.060	50
M12x1.5	3.5	5.0	15	17	10	-	1160.12.050	50
M12x1.5	5.0	6.5	15	17	10	-	1160.12.065	50
M12x1.5	6.5	7.5	15	17	10	-	1160.12.075	50
M16x1.5	8.0	10.5	18	22	10	-	1160.17.105	50
M20x1.5	11.0	14.5	24	23	10	-	1160.20.145	50
M25x1.5	16.0	19.0	30	28	11	-	1160.25.190	25
M32x1.5	21.0	25.5	36	28	13	-	1160.32.255	25
M40x1.5	28.5	33.0	46	34	13	-	1160.40.330	10
M50x1.5	37.0	42.0	55	34	14	-	1160.50.420	10
M63x1.5	46.0	52.0	70	37	14	-	1160.63.520	5
M75x1.5	56.0	63.0	80	38	15	-	1160.75.630	1

1 = Metrisches Regelgewinde

1 = Metric coarse-pitch thread

Erhältlich mit Dichteinsatz gemäss EN 45545. Bei Anfragen oder Bestellung bitte ein F vor die Artikelnummer setzen.

Available with sealing inserts conformity with EN 45545. When placing an inquiry, prefix the article number by the capital F.



Progress MS



Zweiteiliger Dichteinsatz
 durchgehend isolierend

Two-piece sealing insert
 overall length insulated

G	> Ø < min mm	> Ø < max mm	IP	H mm	L mm	Art.-Nr. Art. No.	
M16x1.5	6.0	10.5	18	22	10	1160.17	50
M20x1.5	8.0	14.5	24	23	10	1160.20	50
M25x1.5	12.5	19.0	30	28	11	1160.25	25
M32x1.5	17.0	25.5	36	28	13	1160.32	25
M40x1.5	24.0	33.0	46	31	13	1160.40	10
M50x1.5	33.0	42.0	55	34	14	1160.50	10
M63x1.5	40.0	52.0	70	37	14	1160.63	5
M75x1.5	50.0	63.0	80	38	15	1160.75	1

Erhältlich mit Dichteinsatz gemäss EN 45545. Bei Anfragen oder Bestellung bitte ein F vor die Artikelnummer setzen.

Available with sealing inserts conformity with EN 45545. When placing an inquiry, prefix the article number by the capital F.



Kabelverschraubungen Progress® Messing

Cable glands Progress® nickel-plated brass

Langes Anschlussgewinde metrisch | Long entry thread metric

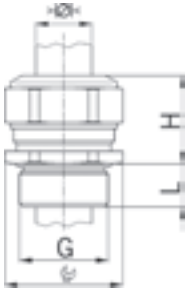

Material: Messing vernickelt
 Dichtung: TPE
 O-Ring : NBR
 Zugentlastung: Ausführung A
 Einsatztemperatur: -40°C / +100°C
 Schutzart: IP 68 (bis 10 bar)
 Weitere Schutzart: IP 69K

Material: Nickel-plated brass
 Seal: TPE
 O-ring : NBR
 Strain relief: Version A
 Temperature range: -40°C / +100°C
 Protection class: IP 68 (up to 10 bar)
 Further protection: IP 69K



Progress MS



Einteiliger Dichteinsatz
 nicht durchgehend isolierend

One-piece sealing insert
 not overall length insulated

G	> Ø < min mm	> Ø < max mm	PG	H mm	L mm	i info	Art.-Nr. Art. No.	
M6x1.0	2.0	2.5	8	12	8	1	1100.06.025	50
M6x1.0	2.5	3.0	8	12	8	1	1100.06.030	50
M6x1.0	3.0	3.5	8	12	8	1	1100.06.035	50
M8x1.25	2.5	3.5	11	14	10	1	1100.08.035	50
M8x1.25	3.5	5.0	11	14	10	1	1100.08.050	50
M10x1.5	3.0	4.0	13	15	10	1	1100.10.040	50
M10x1.5	4.0	6.0	13	15	10	1	1100.10.060	50
M12x1.5	3.5	5.0	15	17	10	-	1100.12.050	50
M12x1.5	5.0	6.5	15	17	10	-	1100.12.065	50
M12x1.5	6.5	8.0	15	17	10	-	1100.12.080	50
M16x1.5	3.5	4.5	18	20	10	-	1100.17.045	50
M16x1.5	4.5	6.0	18	20	10	-	1100.17.060	50
M16x1.5	6.0	8.0	18	20	10	-	1100.17.080	50
M16x1.5	8.0	10.5	18	22	10	-	1100.17.105	50
M20x1.5	6.0	8.0	24	21	10	-	1100.20.080	50
M20x1.5	8.0	11.0	24	21	10	-	1100.20.110	50
M20x1.5	11.0	15.0	24	23	10	-	1100.20.150	50
M25x1.5	9.5	12.5	30	25	11	-	1100.25.125	25
M25x1.5	12.5	16.0	30	27	11	-	1100.25.160	25
M25x1.5	16.0	20.5	30	28	11	-	1100.25.205	25
M32x1.5	14.0	17.0	36	28	13	-	1100.32.170	25
M32x1.5	17.0	21.0	36	28	13	-	1100.32.210	25
M32x1.5	21.0	25.5	36	28	13	-	1100.32.255	25
M40x1.5	20.0	24.0	46	31	13	-	1100.40.240	10
M40x1.5	24.0	28.5	46	31	13	-	1100.40.285	10
M40x1.5	28.5	33.0	46	31	13	-	1100.40.330	10
M50x1.5	29.0	33.0	55	34	14	-	1100.50.330	10
M50x1.5	33.0	37.0	55	34	14	-	1100.50.370	10
M50x1.5	37.0	42.0	55	34	14	-	1100.50.420	10
M63x1.5	35.0	40.0	70	37	14	-	1100.63.400	5
M63x1.5	40.0	46.0	70	37	14	-	1100.63.460	5
M63x1.5	46.0	52.0	70	37	14	-	1100.63.520	5
M75x1.5	45.0	50.0	80	38	15	-	1100.75.500	1
M75x1.5	50.0	56.0	80	38	15	-	1100.75.560	1
M75x1.5	56.0	63.0	80	38	15	-	1100.75.630	1

1 = Metrisches Regelgewinde

1 = Metric coarse-pitch thread

Erhältlich mit Dichteinsatz gemäss EN 45545. Bei Anfragen oder Bestellung bitte ein F vor die Artikelnummer setzen.

Available with sealing inserts conformity with EN 45545. When placing an inquiry, prefix the article number by the capital F.

Kabelverschraubungen Progress® Messing

Cable glands Progress® nickel-plated brass

Langes Anschlussgewinde metrisch | Long entry thread metric

Material: Messing vernickelt
 Dichtung: TPE
 O-Ring : NBR
 Zugentlastung: Ausführung A
 Einsatztemperatur: -40°C / +100°C
 Schutzart: IP 68 (bis 10 bar)
 Weitere Schutzart: IP 69K

Material: Nickel-plated brass
 Seal: TPE
 O-ring : NBR
 Strain relief: Version A
 Temperature range: -40°C / +100°C
 Protection class: IP 68 (up to 10 bar)
 Further protection: IP 69K

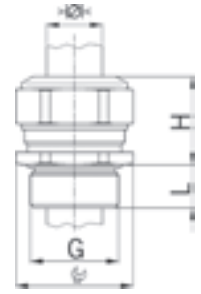

Progress MS



Zweiteiliger Dichteinsatz
 nicht durchgehend isolierend

Two-piece sealing insert
 not overall length insulated

G	> Ø < min mm	> Ø < max mm	IP	H mm	L mm	Art.-Nr. Art. No.	
M16x1.5	6.0	10.5	18	22	10	1100.17	50
M20x1.5	8.0	15.0	24	23	10	1100.20	50
M25x1.5	12.5	20.5	30	28	11	1100.25	25
M32x1.5	17.0	25.5	36	28	13	1100.32	25
M40x1.5	24.0	33.0	46	31	13	1100.40	10
M50x1.5	33.0	42.0	55	34	14	1100.50	10
M63x1.5	40.0	52.0	70	37	14	1100.63	5
M75x1.5	50.0	63.0	80	38	15	1100.75	1

Erhältlich mit Dichteinsatz gemäss EN 45545. Bei Anfragen oder Bestellung bitte ein F vor die Artikelnummer setzen.

Available with sealing inserts conformity with EN 45545. When placing an inquiry, prefix the article number by the capital F.



Kabelverschraubungen Progress® Messing

Cable glands Progress® nickel-plated brass

Kurzes Anschlussgewinde Pg | Short entry thread Pg

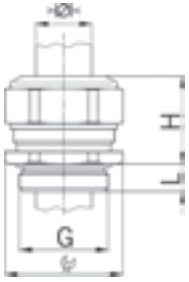

Material: Messing vernickelt
 Dichtung: TPE
 O-Ring : NBR
 Einsatztemperatur: -40°C / +100°C
 Schutzart: IP 68 (bis 10 bar)
 Weitere Schutzart: IP 69K

Material: Nickel-plated brass
 Seal: TPE
 O-ring : NBR
 Temperature range: -40°C / +100°C
 Protection class: IP 68 (up to 10 bar)
 Further protection: IP 69K



Progress MS

Einteiliger Dichteinsatz
 durchgehend isolierend

One-piece sealing insert
 overall length insulated

G	>Ø< min mm	>Ø< max mm		H mm	L mm	Art.-Nr. Art. No.	
Pg 7	3.5	5.0	15	17	6.0	1060.07.050	50
Pg 7	5.0	6.5	15	17	6.0	1060.07.065	50
Pg 7	6.5	7.5	15	17	6.0	1060.07.075	50
Pg 9	4.5	6.0	18	20	6.0	1060.09.060	50
Pg 9	6.0	8.0	18	20	6.0	1060.09.080	50
Pg 9	8.0	10.5	18	22	6.0	1060.09.105	50
Pg 11	4.0	5.5	21	21	6.0	1060.11.055	50
Pg 11	5.5	8.5	21	21	6.0	1060.11.085	50
Pg 11	8.5	12.0	21	21	6.0	1060.11.120	50
Pg 13	6.0	8.0	24	21	6.0	1060.13.080	50
Pg 13	8.0	11.0	24	21	6.0	1060.13.110	50
Pg 13	11.0	14.5	24	23	6.0	1060.13.145	50
Pg 16	6.0	8.0	24	23	6.0	1060.16.080	50
Pg 16	8.0	11.0	24	23	6.0	1060.16.110	50
Pg 16	11.0	14.5	24	23	6.0	1060.16.145	50
Pg 21	9.5	12.5	30	28	7.5	1060.21.125	25
Pg 21	12.5	16.0	30	28	7.5	1060.21.160	25
Pg 21	16.0	19.0	30	28	7.5	1060.21.190	25
Pg 29	19.0	23.0	38	28	8.0	1060.29.230	25
Pg 29	23.0	27.5	38	28	8.0	1060.29.275	25
Pg 36	26.0	30.5	50	32	8.0	1060.36.305	10
Pg 36	30.5	35.0	50	32	8.0	1060.36.350	10
Pg 42	33.0	37.0	55	34	10.0	1060.42.370	10
Pg 42	37.0	42.0	55	34	10.0	1060.42.420	10
Pg 48	37.0	43.0	65	37	11.0	1060.48.430	10
Pg 48	43.0	49.0	65	37	11.0	1060.48.490	10

Erhältlich mit Dichteinsatz gemäss EN 45545. Bei Anfragen oder Bestellung bitte ein F vor die Artikelnummer setzen.

Available with sealing inserts conformity with EN 45545. When placing an inquiry, prefix the article number by the capital F.



Progress MS

Zweiteiliger Dichteinsatz
 durchgehend isolierend

Two-piece sealing insert
 overall length insulated

G	>Ø< min mm	>Ø< max mm		H mm	L mm	Art.-Nr. Art. No.	
Pg 9	6.0	10.5	18	22	6.0	1060.09	50
Pg 11	5.5	12.0	21	21	6.0	1060.11	50
Pg 13	8.0	14.5	24	23	6.0	1060.13	50
Pg 16	8.0	14.5	24	23	6.0	1060.16	50
Pg 21	12.5	19.0	30	28	7.5	1060.21	25
Pg 29	19.0	27.5	38	28	8.0	1060.29	25
Pg 36	26.0	35.0	50	32	8.0	1060.36	10
Pg 42	33.0	42.0	55	34	10.0	1060.42	10
Pg 48	37.0	49.0	65	37	11.0	1060.48	10

Erhältlich mit Dichteinsatz gemäss EN 45545. Bei Anfragen oder Bestellung bitte ein F vor die Artikelnummer setzen.

Available with sealing inserts conformity with EN 45545. When placing an inquiry, prefix the article number by the capital F.

Kabelverschraubungen Progress® Messing

Cable glands Progress® nickel-plated brass

Kurzes Anschlussgewinde Pg | Short entry thread Pg

Material: Messing vernickelt
 Dichtung: TPE
 O-Ring : NBR
 Einsatztemperatur: -40°C / +100°C
 Schutzart: IP 68 (bis 10 bar)
 Weitere Schutzart: IP 69K

Material: Nickel-plated brass
 Seal: TPE
 O-ring : NBR
 Temperature range: -40°C / +100°C
 Protection class: IP 68 (up to 10 bar)
 Further protection: IP 69K

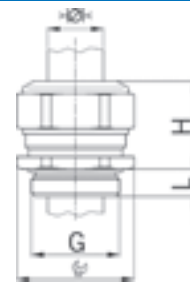

Progress MS

Einteiliger Dichteinsatz
 nicht durchgehend isolierend

One-piece sealing insert
 not overall length insulated



G	> Ø < min mm	> Ø < max mm		H mm	L mm	Art.-Nr. Art. No.	
Pg 7	3.5	5.0	15	17	6.0	1000.07.050	50
Pg 7	5.0	6.5	15	17	6.0	1000.07.065	50
Pg 7	6.5	8.0	15	17	6.0	1000.07.080	50
Pg 9	3.5	4.5	18	20	6.0	1000.09.045	50
Pg 9	4.5	6.0	18	20	6.0	1000.09.060	50
Pg 9	6.0	8.0	18	20	6.0	1000.09.080	50
Pg 9	8.0	10.5	18	22	6.0	1000.09.105	50
Pg 11	4.0	5.5	21	21	6.0	1000.11.055	50
Pg 11	5.5	8.5	21	21	6.0	1000.11.085	50
Pg 11	8.5	12.0	21	21	6.0	1000.11.120	50
Pg 13	6.0	8.0	24	21	6.0	1000.13.080	50
Pg 13	8.0	11.0	24	21	6.0	1000.13.110	50
Pg 13	11.0	15.0	24	23	6.0	1000.13.150	50
Pg 16	6.0	8.0	24	23	6.0	1000.16.080	50
Pg 16	8.0	11.0	24	23	6.0	1000.16.110	50
Pg 16	11.0	15.0	24	23	6.0	1000.16.150	50
Pg 21	9.5	12.5	30	28	7.5	1000.21.125	25
Pg 21	12.5	16.0	30	28	7.5	1000.21.160	25
Pg 21	16.0	20.5	30	28	7.5	1000.21.205	25
Pg 29	16.0	19.0	38	28	8.0	1000.29.190	25
Pg 29	19.0	23.0	38	28	8.0	1000.29.230	25
Pg 29	23.0	27.5	38	28	8.0	1000.29.275	25
Pg 36	21.5	26.0	50	32	8.0	1000.36.260	10
Pg 36	26.0	30.5	50	32	8.0	1000.36.305	10
Pg 36	30.5	35.0	50	32	8.0	1000.36.350	10
Pg 42	29.0	33.0	55	34	10.0	1000.42.330	10
Pg 42	33.0	37.0	55	34	10.0	1000.42.370	10
Pg 42	37.0	42.0	55	34	10.0	1000.42.420	10
Pg 48	32.0	37.0	65	37	11.0	1000.48.370	10
Pg 48	37.0	43.0	65	37	11.0	1000.48.430	10
Pg 48	43.0	49.0	65	37	11.0	1000.48.490	10



Erhältlich mit Dichteinsatz gemäss EN 45545. Bei Anfragen oder Bestellung bitte ein F vor die Artikelnummer setzen.

Available with sealing inserts conformity with EN 45545. When placing an inquiry, prefix the article number by the capital F.

Kabelverschraubungen Progress® Messing

Cable glands Progress® nickel-plated brass

Kurzes Anschlussgewinde Pg | Short entry thread Pg

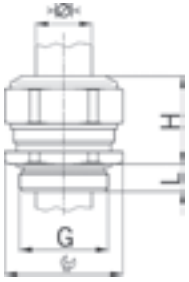

Material: Messing vernickelt
 Dichtung: TPE
 O-Ring : NBR
 Einsatztemperatur: -40°C / +100°C
 Schutzart: IP 68 (bis 10 bar)
 Weitere Schutzart: IP 69K

Material: Nickel-plated brass
 Seal: TPE
 O-ring : NBR
 Temperature range: -40°C / +100°C
 Protection class: IP 68 (up to 10 bar)
 Further protection: IP 69K





Progress MS

Zweiteiliger Dichteinsatz
 nicht durchgehend isolierend

Two-piece sealing insert
 not overall length insulated



G	> Ø < min mm	> Ø < max mm		H mm	L mm	Art.-Nr. Art. No.	
Pg 9	6.0	10.5	18	22	6.0	1000.09	50
Pg 11	5.5	12.0	21	21	6.0	1000.11	50
Pg 13	8.0	15.0	24	23	6.0	1000.13	50
Pg 16	8.0	15.0	24	23	6.0	1000.16	50
Pg 21	12.5	20.5	30	28	7.5	1000.21	25
Pg 29	19.0	27.5	38	28	8.0	1000.29	25
Pg 36	26.0	35.0	50	32	8.0	1000.36	10
Pg 42	33.0	42.0	55	34	10.0	1000.42	10
Pg 48	37.0	49.0	65	37	11.0	1000.48	10

Erhältlich mit Dichteinsatz gemäss EN 45545. Bei Anfragen oder Bestellung bitte ein F vor die Artikelnummer setzen.

Available with sealing inserts conformity with EN 45545. When placing an inquiry, prefix the article number by the capital F.

Kabelverschraubungen Progress® Messing

Cable glands Progress® nickel-plated brass

Langes Anschlussgewinde Pg | Long entry thread Pg

Material: Messing vernickelt
 Dichtung: TPE
 O-Ring : NBR
 Einsatztemperatur: -40°C / +100°C
 Schutzart: IP 68 (bis 10 bar)
 Weitere Schutzart: IP 69K

Material: Nickel-plated brass
 Seal: TPE
 O-ring : NBR
 Temperature range: -40°C / +100°C
 Protection class: IP 68 (up to 10 bar)
 Further protection: IP 69K

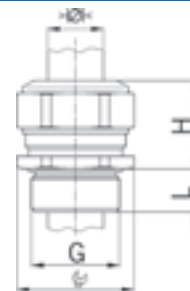

Progress MS

Einteiliger Dichteinsatz
 durchgehend isolierend

One-piece sealing insert
 overall length insulated

G	> Ø < min mm	> Ø < max mm		H mm	L mm	Art.-Nr. Art. No.	
Pg 7	5.0	6.5	15	17	10	1160.07.065	50
Pg 7	6.5	7.5	15	17	10	1160.07.075	50
Pg 9	8.0	10.5	18	22	10	1160.09.105	50
Pg 11	8.5	12.0	21	21	10	1160.11.120	50
Pg 13	11.0	14.5	24	23	10	1160.13.145	50
Pg 16	11.0	14.5	24	23	10	1160.16.145	50
Pg 21	16.0	19.0	30	28	12	1160.21.190	25
Pg 29	23.0	27.5	38	28	12	1160.29.275	25
Pg 36	30.5	35.0	50	32	15	1160.36.350	10
Pg 42	37.0	42.0	55	32	15	1160.42.420	10
Pg 48	43.0	49.0	65	37	15	1160.48.490	10

Erhältlich mit Dichteinsatz gemäss EN 45545. Bei Anfragen oder Bestellung bitte ein F vor die Artikelnummer setzen.

Available with sealing inserts conformity with EN 45545. When placing an inquiry, prefix the article number by the capital F.



Progress MS

Zweiteiliger Dichteinsatz
 durchgehend isolierend

Two-piece sealing insert
 overall length insulated

G	> Ø < min mm	> Ø < max mm		H mm	L mm	Art.-Nr. Art. No.	
Pg 9	6.0	10.5	18	22	10	1160.09	50
Pg 11	5.5	12.0	21	21	10	1160.11	50
Pg 13	8.0	14.5	24	23	10	1160.13	50
Pg 16	8.0	14.5	24	23	10	1160.16	50
Pg 21	12.5	19.0	30	28	12	1160.21	25
Pg 29	19.0	27.5	38	28	12	1160.29	25
Pg 36	26.0	35.0	50	32	15	1160.36	10
Pg 42	33.0	42.0	55	34	15	1160.42	10
Pg 48	37.0	49.0	65	37	15	1160.48	10

Erhältlich mit Dichteinsatz gemäss EN 45545. Bei Anfragen oder Bestellung bitte ein F vor die Artikelnummer setzen.

Available with sealing inserts conformity with EN 45545. When placing an inquiry, prefix the article number by the capital F.



Kabelverschraubungen Progress® Messing

Cable glands Progress® nickel-plated brass

Langes Anschlussgewinde Pg | Long entry thread Pg

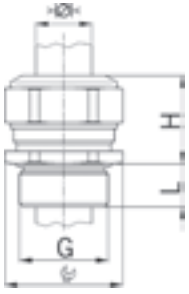

Material: Messing vernickelt
 Dichtung: TPE
 O-Ring : NBR
 Einsatztemperatur: -40°C / +100°C
 Schutzart: IP 68 (bis 10 bar)
 Weitere Schutzart: IP 69K

Material: Nickel-plated brass
 Seal: TPE
 O-ring : NBR
 Temperature range: -40°C / +100°C
 Protection class: IP 68 (up to 10 bar)
 Further protection: IP 69K



Progress MS

Einteiliger Dichteinsatz
 nicht durchgehend isolierend

One-piece sealing insert
 not overall length insulated

G	> Ø < min mm	> Ø < max mm		H mm	L mm	Art.-Nr. Art. No.	
Pg 7	3.5	5.0	15	17	10	1100.07.050	50
Pg 7	5.0	6.5	15	17	10	1100.07.065	50
Pg 7	6.5	8.0	15	17	10	1100.07.080	50
Pg 9	3.5	4.5	18	20	10	1100.09.045	50
Pg 9	4.5	6.0	18	20	10	1100.09.060	50
Pg 9	6.0	8.0	18	20	10	1100.09.080	50
Pg 9	8.0	10.5	18	22	10	1100.09.105	50
Pg 11	4.0	5.5	21	21	10	1100.11.055	50
Pg 11	5.5	8.5	21	21	10	1100.11.085	50
Pg 11	8.5	12.0	21	21	10	1100.11.120	50
Pg 13	6.0	8.0	24	21	10	1100.13.080	50
Pg 13	8.0	11.0	24	21	10	1100.13.110	50
Pg 13	11.0	15.0	24	23	10	1100.13.150	50
Pg 16	6.0	8.0	24	23	10	1100.16.080	50
Pg 16	8.0	11.0	24	23	10	1100.16.110	50
Pg 16	11.0	15.0	24	23	10	1100.16.150	50
Pg 21	9.5	12.5	30	28	12	1100.21.125	25
Pg 21	12.5	16.0	30	28	12	1100.21.160	25
Pg 21	16.0	20.5	30	28	12	1100.21.205	25
Pg 29	16.0	19.0	38	28	12	1100.29.190	25
Pg 29	19.0	23.0	38	28	12	1100.29.230	25
Pg 29	23.0	27.5	38	28	12	1100.29.275	25
Pg 36	21.5	26.0	50	32	15	1100.36.260	10
Pg 36	26.0	30.5	50	32	15	1100.36.305	10
Pg 36	30.5	35.0	50	32	15	1100.36.350	10
Pg 42	29.0	33.0	55	34	15	1100.42.330	10
Pg 42	33.0	37.0	55	34	15	1100.42.370	10
Pg 42	37.0	42.0	55	34	15	1100.42.420	10
Pg 48	32.0	37.0	65	37	15	1100.48.370	10
Pg 48	37.0	43.0	65	37	15	1100.48.430	10
Pg 48	43.0	49.0	65	37	15	1100.48.490	10

Erhältlich mit Dichteinsatz gemäss EN 45545. Bei Anfragen oder Bestellung bitte ein F vor die Artikelnummer setzen.

Available with sealing inserts conformity with EN 45545. When placing an inquiry, prefix the article number by the capital F.

Kabelverschraubungen Progress® Messing

Cable glands Progress® nickel-plated brass

Langes Anschlussgewinde Pg | Long entry thread Pg

Material: Messing vernickelt
 Dichtung: TPE
 O-Ring : NBR
 Einsatztemperatur: -40°C / +100°C
 Schutzart: IP 68 (bis 10 bar)
 Weitere Schutzart: IP 69K

Material: Nickel-plated brass
 Seal: TPE
 O-ring : NBR
 Temperature range: -40°C / +100°C
 Protection class: IP 68 (up to 10 bar)
 Further protection: IP 69K

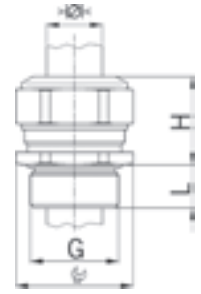

Progress MS



Zweiteiliger Dichteinsatz
 nicht durchgehend isolierend

Two-piece sealing insert
 not overall length insulated

G	> Ø < min mm	> Ø < max mm		H mm	L mm	Art.-Nr. Art. No.	
Pg 9	6.0	10.5	18	22	10	1100.09	50
Pg 11	5.5	12.0	21	21	10	1100.11	50
Pg 13	8.0	15.0	24	23	10	1100.13	50
Pg 16	8.0	15.0	24	23	10	1100.16	50
Pg 21	12.5	20.5	30	28	12	1100.21	25
Pg 29	19.0	27.5	38	28	12	1100.29	25
Pg 36	26.0	35.0	50	32	15	1100.36	10
Pg 42	33.0	42.0	55	34	15	1100.42	10
Pg 48	37.0	49.0	65	37	15	1100.48	10

Erhältlich mit Dichteinsatz gemäss EN 45545. Bei Anfragen oder Bestellung bitte ein F vor die Artikelnummer setzen.

Available with sealing inserts conformity with EN 45545. When placing an inquiry, prefix the article number by the capital F.



Kabelverschraubungen Progress® Messing

Cable glands Progress® nickel-plated brass

Anschlussgewinde NPT | Entry thread NPT

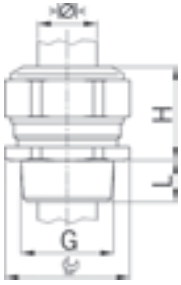

Material: Messing vernickelt
 Dichtung: TPE
 Einsatztemperatur: -40°C / +100°C
 Schutzart: IP 68 (bis 10 bar)
 Weitere Schutzart: IP 69K
 Gewinde: IP 68, wenn Anschluss-
 gewinde abgedichtet

Material: Nickel-plated brass
 Seal: TPE
 Temperature range: -40°C / +100°C
 Protection class: IP 68 (up to 10 bar)
 Further protection: IP 69K
 Entry thread: IP 68, if the entry thread
 is sealed



Progress NPT

Einteiliger Dichteinsatz
 nicht durchgehend isolierend

One-piece sealing insert
 not overall length insulated

G	> Ø < min mm	> Ø < max mm		H mm	L mm	Art.-Nr. Art. No.	
NPT 1/8"	3.0	4.0	13	15	8	1000.1/8NPT.040	50
NPT 1/8"	4.0	6.0	13	15	8	1000.1/8NPT.060	50
NPT 1/4"	3.5	5.0	15	17	12	1000.1/4NPT.050	50
NPT 1/4"	5.0	6.5	15	17	12	1000.1/4NPT.065	50
NPT 1/4"	6.5	8.0	15	17	12	1000.1/4NPT.080	50
NPT 3/8"	3.5	4.5	18	20	12	1000.3/8NPT.045	50
NPT 3/8"	4.5	6.0	18	20	12	1000.3/8NPT.060	50
NPT 3/8"	6.0	8.0	18	20	12	1000.3/8NPT.080	50
NPT 3/8"	8.0	10.5	18	22	12	1000.3/8NPT.105	50
NPT 1/2"	6.0	8.0	24	21	15	1000.1/2NPT.080	50
NPT 1/2"	8.0	11.0	24	21	15	1000.1/2NPT.110	50
NPT 1/2"	11.0	15.0	24	23	15	1000.1/2NPT.150	50
NPT 3/4"	9.5	12.5	30	28	15	1000.3/4NPT.125	25
NPT 3/4"	12.5	16.0	30	28	15	1000.3/4NPT.160	25
NPT 3/4"	16.0	20.5	30	28	15	1000.3/4NPT.205	25
NPT 1"	14.0	17.0	36	28	20	1000.1NPT.170	25
NPT 1"	17.0	21.0	36	28	20	1000.1NPT.210	25
NPT 1"	21.0	25.5	36	28	20	1000.1NPT.255	25
NPT 1 1/4"	20.0	24.0	46	31	20	1000.11/4NPT.240	10
NPT 1 1/4"	24.0	28.5	46	31	20	1000.11/4NPT.285	10
NPT 1 1/4"	28.5	33.0	46	31	20	1000.11/4NPT.330	10
NPT 1 1/2"	29.0	33.0	55	34	22	1000.11/2NPT.330	10
NPT 1 1/2"	33.0	37.0	55	34	22	1000.11/2NPT.370	10
NPT 1 1/2"	37.0	41.0	55	34	22	1000.11/2NPT.410	10
NPT 2"	35.0	40.0	70	37	22	1000.2NPT.400	5
NPT 2"	40.0	46.0	70	37	22	1000.2NPT.460	5
NPT 2"	46.0	52.0	70	37	22	1000.2NPT.520	5



Progress NPT

Zweiteiliger Dichteinsatz
 nicht durchgehend isolierend

Two-piece sealing insert
 not overall length insulated

G	> Ø < min mm	> Ø < max mm		H mm	L mm	Art.-Nr. Art. No.	
NPT 3/8"	6.0	10.5	18	22	12	1000.3/8NPT	50
NPT 1/2"	8.0	15.0	24	23	15	1000.1/2NPT	50
NPT 3/4"	12.5	20.5	30	28	15	1000.3/4NPT	25
NPT 1"	17.0	25.5	36	28	20	1000.1NPT	25
NPT 1 1/4"	24.0	33.0	46	31	20	1000.11/4NPT	10
NPT 1 1/2"	33.0	41.0	55	34	22	1000.11/2NPT	10
NPT 2"	40.0	52.0	70	37	22	1000.2NPT	5

Kabelverschraubungen Progress® Messing Cable glands Progress® nickel-plated brass

Anschlussgewinde Gasrohr | Gas-pipe entry thread

Material: Messing vernickelt
Dichtung: TPE
O-Ring : NBR
Einsatztemperatur: -40°C / +100°C
Schutzart: IP 68

Material: Nickel-plated brass
Seal: TPE
O-ring : NBR
Temperature range: -40°C / +100°C
Protection class: IP 68

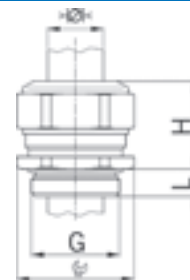

Zweiteiliger Dichteinsatz
nicht durchgehend isolierend

Two-piece sealing insert
not overall length insulated

G	>Ø< min mm	>Ø< max mm		H mm	L mm	i info	Art.-Nr. Art. No.	
G 3/8"	5.5	12.0	21	21	6	-	1000.3/8G	50
G 1/2"	8.0	15.0	24	23	8	-	1000.1/2G	50
G 3/4"	12.5	20.5	30	28	10	-	1000.3/4G	25
G 1"	17.0	25.5	36	28	11	-	1000.1G	25
G 1 1/2"	25.0	35.0	55/50	32	12	-	1000.11/2G	10
G 2"	37.0	49.0	65	37	12	-	1000.2G	10
G 2 1/2"	45.0	50.0	80	38	18	1	1000.21/2G.500	1
G 2 1/2"	50.0	56.0	80	38	18	1	1000.21/2G.560	1
G 3"	56.0	63.0	80	38	18	1	1000.3G.630	1
G 3"	63.0	70.0	95	40	18	1	1000.3G.700	1

1 = Einteiliger Dichteinsatz

1 = One-piece sealing insert



Kabelverschraubungen Progress® Messing für hohe Temperaturen

Cable glands Progress® nickel-plated brass for high temperature applications

Kurzes Anschlussgewinde metrisch | Short entry thread metric

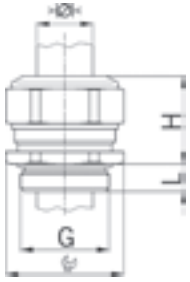

Material: Messing vernickelt
 Dichtung: FPM
 O-Ring : FPM
 Zugentlastung: Ausführung A
 Einsatztemperatur: -40°C / +200°C
 Schutzart: IP 68 (bis 10 bar)
 Weitere Schutzart: IP 69K

Material: Nickel-plated brass
 Seal: FPM
 O-ring : FPM
 Strain relief: Version A
 Temperature range: -40°C / +200°C
 Protection class: IP 68 (up to 10 bar)
 Further protection: IP 69K



Progress MS HT



Einteiliger Dichteinsatz
 nicht durchgehend isolierend

One-piece sealing insert
 not overall length insulated

G	>Ø< min mm	>Ø< max mm	PG	H mm	L mm	i info	Art.-Nr. Art. No.	
M6x1.0	2.0	2.5	8	12	5	1	1000.06.91.025	50
M6x1.0	2.5	3.0	8	12	5	1	1000.06.91.030	50
M6x1.0	3.0	3.5	8	12	5	1	1000.06.91.035	50
M8x1.25	2.5	3.5	11	14	5	1	1000.08.91.035	50
M8x1.25	3.5	5.0	11	14	5	1	1000.08.91.050	50
M10x1.5	3.0	4.0	13	15	5	1	1000.10.91.040	50
M10x1.5	4.0	6.0	13	15	5	1	1000.10.91.060	50
M12x1.5	3.5	5.0	15	17	5	-	1000.12.91.050	50
M12x1.5	5.0	6.5	15	17	5	-	1000.12.91.065	50
M12x1.5	6.5	8.0	15	17	5	-	1000.12.91.080	50
M16x1.5	8.0	10.5	18	22	5	-	1000.17.91.105	50
M20x1.5	11.0	15.0	24	23	6	-	1000.20.91.150	50
M25x1.5	16.0	20.5	30	28	7	-	1000.25.91.205	25
M32x1.5	21.0	25.5	36	28	8	-	1000.32.91.255	25
M40x1.5	28.5	33.0	46	31	8	-	1000.40.91.330	10
M50x1.5	37.0	42.0	55	34	9	-	1000.50.91.420	10
M63x1.5	46.0	52.0	70	37	10	-	1000.63.91.520	5

1 = Metrisches Regelgewinde

1 = Metric coarse-pitch thread



Progress MS HT



Zweiteiliger Dichteinsatz
 nicht durchgehend isolierend

Two-piece sealing insert
 not overall length insulated

G	>Ø< min mm	>Ø< max mm	PG	H mm	L mm	Art.-Nr. Art. No.	
M16x1.5	6.0	10.5	18	22	5	1000.17.92	50
M20x1.5	8.0	15.0	24	23	6	1000.20.92	50
M25x1.5	12.5	20.5	30	28	7	1000.25.92	25
M32x1.5	17.0	25.5	36	28	8	1000.32.92	25
M40x1.5	24.0	33.0	46	31	8	1000.40.92	10
M50x1.5	33.0	42.0	55	34	9	1000.50.92	10
M63x1.5	40.0	52.0	70	37	10	1000.63.92	5

Kabelverschraubungen Progress® Messing für hohe Temperaturen

Cable glands Progress® nickel-plated brass for high temperature applications

Langes Anschlussgewinde metrisch | Long entry thread metric

Material: Messing vernickelt
 Dichtung: FPM
 O-Ring : FPM
 Zugentlastung: Ausführung A
 Einsatztemperatur: -40°C / +200°C
 Schutzart: IP 68 (bis 10 bar)
 Weitere Schutzart: IP 69K

Material: Nickel-plated brass
 Seal: FPM
 O-ring : FPM
 Strain relief: Version A
 Temperature range: -40°C / +200°C
 Protection class: IP 68 (up to 10 bar)
 Further protection: IP 69K

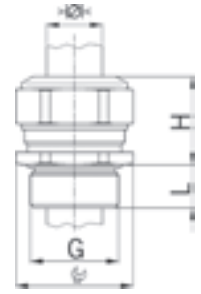

Progress MS HT



Einteiliger Dichteinsatz
 nicht durchgehend isolierend

One-piece sealing insert
 not overall length insulated

G	>Ø< min mm	>Ø< max mm	PG	H mm	L mm	i info	Art.-Nr. Art. No.	
M6x1.0	2.0	2.5	8	12	8	1	1100.06.91.025	50
M6x1.0	2.5	3.0	8	12	8	1	1100.06.91.030	50
M6x1.0	3.0	3.5	8	12	8	1	1100.06.91.035	50
M8x1.25	2.5	3.5	11	14	10	1	1100.08.91.035	50
M8x1.25	3.5	5.0	11	14	10	1	1100.08.91.050	50
M10x1.5	3.0	4.0	13	15	10	1	1100.10.91.040	50
M10x1.5	4.0	6.0	13	15	10	1	1100.10.91.060	50
M12x1.5	3.5	5.0	15	17	10	-	1100.12.91.050	50
M12x1.5	5.0	6.5	15	17	10	-	1100.12.91.065	50
M12x1.5	6.5	8.0	15	17	10	-	1100.12.91.080	50
M16x1.5	8.0	10.5	18	22	10	-	1100.17.91.105	50
M20x1.5	11.0	15.0	24	23	10	-	1100.20.91.150	50
M25x1.5	16.0	20.5	30	28	11	-	1100.25.91.205	25
M32x1.5	21.0	25.5	36	28	13	-	1100.32.91.255	25
M40x1.5	28.5	33.0	46	31	13	-	1100.40.91.330	10
M50x1.5	37.0	42.0	55	34	14	-	1100.50.91.420	10
M63x1.5	46.0	52.0	70	37	14	-	1100.63.91.520	5

1 = Metrisches Regelgewinde

1 = Metric coarse-pitch thread



Progress MS HT



Zweiteiliger Dichteinsatz
 nicht durchgehend isolierend

Two-piece sealing insert
 not overall length insulated

G	>Ø< min mm	>Ø< max mm	PG	H mm	L mm	Art.-Nr. Art. No.	
M16x1.5	6.0	10.5	18	22	10	1100.17.92	50
M20x1.5	8.0	15.0	24	23	10	1100.20.92	50
M25x1.5	12.5	20.5	30	28	11	1100.25.92	25
M32x1.5	17.0	25.5	36	28	13	1100.32.92	25
M40x1.5	24.0	33.0	46	31	13	1100.40.92	10
M50x1.5	33.0	42.0	55	34	14	1100.50.92	10
M63x1.5	40.0	52.0	70	37	14	1100.63.92	5



Kabelverschraubungen Progress® Messing für hohe Temperaturen

Cable glands Progress® nickel-plated brass for high temperature applications

Kurzes Anschlussgewinde Pg | Short entry thread Pg

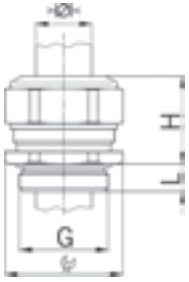

Material: Messing vernickelt
 Dichtung: FPM
 O-Ring : FPM
 Einsatztemperatur: -40°C / +200°C
 Schutzart: IP 68 (bis 10 bar)
 Weitere Schutzart: IP 69K

Material: Nickel-plated brass
 Seal: FPM
 O-ring : FPM
 Temperature range: -40°C / +200°C
 Protection class: IP 68 (up to 10 bar)
 Further protection: IP 69K



Progress MS HT



Einteiliger Dichteinsatz
 nicht durchgehend isolierend

One-piece sealing insert
 not overall length insulated

G	> Ø < min mm	> Ø < max mm	PG	H mm	L mm	Art.-Nr. Art. No.	
Pg 7	3.5	5.0	15	17	6	1000.07.91.050	50
Pg 7	5.0	6.5	15	17	6	1000.07.91.065	50
Pg 7	6.5	8.0	15	17	6	1000.07.91.080	50
Pg 9	8.0	10.5	18	22	6	1000.09.91.105	50
Pg 11	8.5	12.0	21	21	6	1000.11.91.120	50
Pg 13	11.0	15.0	24	23	6	1000.13.91.150	50
Pg 16	11.0	15.0	24	23	6	1000.16.91.150	50
Pg 21	16.0	20.5	30	28	7	1000.21.91.205	25
Pg 29	23.0	27.5	38	28	8	1000.29.91.275	25
Pg 36	30.5	35.0	50	32	8	1000.36.91.350	10
Pg 42	37.0	42.0	55	34	10	1000.42.91.420	10
Pg 48	43.0	49.0	65	37	11	1000.48.91.490	10



Progress MS HT



Zweiteiliger Dichteinsatz
 nicht durchgehend isolierend

Two-piece sealing insert
 not overall length insulated

G	> Ø < min mm	> Ø < max mm	PG	H mm	L mm	Art.-Nr. Art. No.	
Pg 9	6.0	10.5	18	22	6	1000.09.92	50
Pg 11	5.5	12.0	21	21	6	1000.11.92	50
Pg 13	8.0	15.0	24	23	6	1000.13.92	50
Pg 16	8.0	15.0	24	23	6	1000.16.92	50
Pg 21	12.5	20.5	30	28	7	1000.21.92	25
Pg 29	19.0	27.5	38	28	8	1000.29.92	25
Pg 36	26.0	35.0	50	32	8	1000.36.92	10
Pg 42	33.0	42.0	55	34	10	1000.42.92	10
Pg 48	37.0	49.0	65	37	11	1000.48.92	10

Kabelverschraubungen Progress® Messing für hohe Temperaturen

Cable glands Progress® nickel-plated brass for high temperature applications

Langes Anschlussgewinde Pg | Long entry thread Pg

Material: Messing vernickelt
 Dichtung: FPM
 O-Ring : FPM
 Einsatztemperatur: -40°C / +200°C
 Schutzart: IP 68 (bis 10 bar)
 Weitere Schutzart: IP 69K

Material: Nickel-plated brass
 Seal: FPM
 O-ring : FPM
 Temperature range: -40°C / +200°C
 Protection class: IP 68 (up to 10 bar)
 Further protection: IP 69K

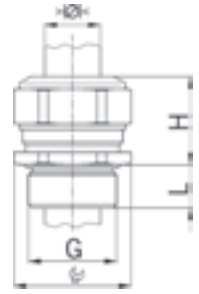

Progress MS HT

Einteiliger Dichteinsatz
 nicht durchgehend isolierend

One-piece sealing insert
 not overall length insulated

G	>Ø< min mm	>Ø< max mm		H mm	L mm	Art.-Nr. Art. No.	
Pg 7	3.5	5.0	15	17	10	1100.07.91.050	50
Pg 7	5.0	6.5	15	17	10	1100.07.91.065	50
Pg 7	6.5	8.0	15	17	10	1100.07.91.080	50
Pg 9	8.0	10.5	18	22	10	1100.09.91.105	50
Pg 11	8.5	12.0	21	21	10	1100.11.91.120	50
Pg 13	11.0	15.0	24	23	10	1100.13.91.150	50
Pg 16	11.0	15.0	24	23	10	1100.16.91.150	50
Pg 21	16.0	20.5	30	28	12	1100.21.91.205	25
Pg 29	23.0	27.5	38	28	12	1100.29.91.275	25
Pg 36	30.5	35.0	50	32	15	1100.36.91.350	10
Pg 42	37.0	42.0	55	34	15	1100.42.91.420	10
Pg 48	43.0	49.0	65	37	15	1100.48.91.490	10



Progress MS HT

Zweiteiliger Dichteinsatz
 nicht durchgehend isolierend

Two-piece sealing insert
 not overall length insulated

G	>Ø< min mm	>Ø< max mm		H mm	L mm	Art.-Nr. Art. No.	
Pg 9	6.0	10.5	18	22	10	1100.09.92	50
Pg 11	5.5	12.0	21	21	10	1100.11.92	50
Pg 13	8.0	15.0	24	23	10	1100.13.92	50
Pg 16	8.0	15.0	24	23	10	1100.16.92	50
Pg 21	12.5	20.5	30	28	12	1100.21.92	25
Pg 29	19.0	27.5	38	28	12	1100.29.92	25
Pg 36	26.0	35.0	50	32	15	1100.36.92	10
Pg 42	33.0	42.0	55	34	15	1100.42.92	10
Pg 48	37.0	49.0	65	37	15	1100.48.92	10



Kabelverschraubungen Progress® Messing für mehrere Kabel

Cable glands Progress® nickel-plated brass for installation of multiple cables

Kurzes Anschlussgewinde metrisch | Short entry thread metric

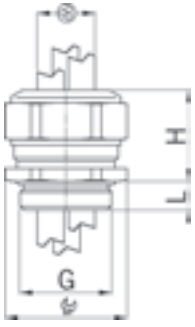

Material: Messing vernickelt
 Dichtung: TPE
 O-Ring : NBR
 Zugentlastung: Ausführung A
 Einsatztemperatur: -40°C / +100°C
 Schutzart: IP 68

Material: Nickel-plated brass
 Seal: TPE
 O-ring : NBR
 Strain relief: Version A
 Temperature range: -40°C / +100°C
 Protection class: IP 68



Progress MS Multi



Einteiliger Dichteinsatz
 nicht durchgehend isolierend

One-piece sealing insert
 not overall length insulated

G	> Ø < min mm	> Ø < max mm			H mm	L mm	Art.-Nr. Art. No.	
M16x1.5	2.0	3.0	2	18	22	5	1310.17.2.030	50
M16x1.5	2.5	4.0	2	18	22	5	1310.17.2.040	50
M16x1.5	3.5	5.0	2	18	22	5	1310.17.2.050	50
M20x1.5	3.5	5.0	2	24	23	6	1310.20.2.050	50
M20x1.5	4.5	6.0	2	24	23	6	1310.20.2.060	50
M20x1.5	5.5	7.5	2	24	23	6	1310.20.2.075	50
M20x1.5	3.5	5.0	3	24	23	6	1310.20.3.050	50
M20x1.5	4.5	6.0	3	24	23	6	1310.20.3.060	50
M20x1.5	5.2	6.5	3	24	23	6	1310.20.3.065	50
M20x1.5	3.5	5.0	4	24	23	6	1310.20.4.050	50
M20x1.5	4.5	6.0	4	24	23	6	1310.20.4.060	50
M25x1.5	5.0	7.0	2	30	28	7	1310.25.2.070	25
M25x1.5	6.7	9.0	2	30	28	7	1310.25.2.090	25
M25x1.5	7.7	10.0	2	30	28	7	1310.25.2.100	25
M25x1.5	5.5	7.0	3	30	28	7	1310.25.3.070	25
M25x1.5	6.8	9.0	3	30	28	7	1310.25.3.090	25
M25x1.5	5.5	7.0	4	30	28	7	1310.25.4.070	25
M25x1.5	4.8	6.0	6	30	28	7	1310.25.6.060	25
M32x1.5	9.0	11.5	2	36	28	8	1310.32.2.115	25
M32x1.5	7.0	9.0	3	36	28	8	1310.32.3.090	25
M32x1.5	8.5	10.5	3	36	28	8	1310.32.3.105	25
M32x1.5	7.0	9.0	4	36	28	8	1310.32.4.090	25
M32x1.5	5.8	7.0	6	36	28	8	1310.32.6.070	25

Weitere Ausführungen und Anschlussgewinde auf Anfrage

Further versions and entry threads are available upon request.

Erhältlich mit Dichteinsatz gemäss EN 45545. Bei Anfragen oder Bestellung bitte ein F vor die Artikelnummer setzen.

Available with sealing inserts conformity with EN 45545. When placing an inquiry, prefix the article number by the capital F.

Kabelverschraubungen Progress® Messing für mehrere Kabel Cable glands Progress® nickel-plated brass for installation of multiple cables

Langes Anschlussgewinde metrisch | Long entry thread metric

Material: Messing vernickelt
Dichtung: TPE
O-Ring : NBR
Zugentlastung: Ausführung A
Einsatztemperatur: -40°C / +100°C
Schutzart: IP 68

Material: Nickel-plated brass
Seal: TPE
O-ring : NBR
Strain relief: Version A
Temperature range: -40°C / +100°C
Protection class: IP 68

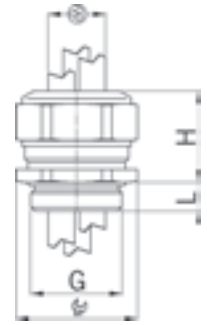

Progress MS Multi



Einteiliger Dichteinsatz
nicht durchgehend isolierend

One-piece sealing insert
not overall length insulated

G	>Ø< min mm	>Ø< max mm			H mm	L mm	Art.-Nr. Art. No.	
M16x1.5	2.0	3.0	2	18	22	10	1311.17.2.030	50
M16x1.5	2.5	4.0	2	18	22	10	1311.17.2.040	50
M16x1.5	3.5	5.0	2	18	22	10	1311.17.2.050	50
M20x1.5	3.5	5.0	2	24	23	10	1311.20.2.050	50
M20x1.5	4.5	6.0	2	24	23	10	1311.20.2.060	50
M20x1.5	5.5	7.5	2	24	23	10	1311.20.2.075	50
M20x1.5	3.5	5.0	3	24	23	10	1311.20.3.050	50
M20x1.5	4.5	6.0	3	24	23	10	1311.20.3.060	50
M20x1.5	5.2	6.5	3	24	23	10	1311.20.3.065	50
M20x1.5	3.5	5.0	4	24	23	10	1311.20.4.050	50
M20x1.5	4.5	6.0	4	24	23	10	1311.20.4.060	50
M25x1.5	5.0	7.0	2	30	28	11	1311.25.2.070	25
M25x1.5	6.7	9.0	2	30	28	11	1311.25.2.090	25
M25x1.5	7.7	10.0	2	30	28	11	1311.25.2.100	25
M25x1.5	5.5	7.0	3	30	28	11	1311.25.3.070	25
M25x1.5	6.8	9.0	3	30	28	11	1311.25.3.090	25
M25x1.5	5.5	7.0	4	30	28	11	1311.25.4.070	25
M25x1.5	4.8	6.0	6	30	28	11	1311.25.6.060	25
M32x1.5	9.0	11.5	2	36	28	13	1311.32.2.115	25
M32x1.5	7.0	9.0	3	36	28	13	1311.32.3.090	25
M32x1.5	8.5	10.5	3	36	28	13	1311.32.3.105	25
M32x1.5	7.0	9.0	4	36	28	13	1311.32.4.090	25
M32x1.5	5.8	7.0	6	36	28	13	1311.32.6.070	25



Weitere Ausführungen und Anschlussgewinde auf Anfrage

Further versions and entry threads are available upon request.

Erhältlich mit Dichteinsatz gemäss EN 45545. Bei Anfragen oder Bestellung bitte ein F vor die Artikelnummer setzen.

Available with sealing inserts conformity with EN 45545. When placing an inquiry, prefix the article number by the capital F.

Kabelverschraubungen Progress® Messing für mehrere Kabel

Cable glands Progress® nickel-plated brass for installation of multiple cables

Kurzes Anschlussgewinde Pg | Short entry thread Pg

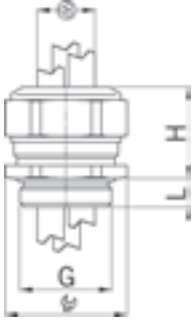

Material: Messing vernickelt
 Dichtung: TPE
 O-Ring : NBR
 Einsatztemperatur: -40°C / +100°C
 Schutzart: IP 68

Material: Nickel-plated brass
 Seal: TPE
 O-ring : NBR
 Temperature range: -40°C / +100°C
 Protection class: IP 68



Progress MS Multi



Einteiliger Dichteinsatz
 nicht durchgehend isolierend

One-piece sealing insert
 not overall length insulated

G	> Ø < min mm	> Ø < max mm	⊗	⊗	H mm	L mm	Art.-Nr. Art. No.	⊞
Pg 9	2.0	3.0	2	18	22	6.0	1310.09.2.030	50
Pg 9	2.5	4.0	2	18	22	6.0	1310.09.2.040	50
Pg 9	3.5	5.0	2	18	22	6.0	1310.09.2.050	50
Pg 11	3.5	5.0	2	21	21	6.0	1310.11.2.050	50
Pg 11	4.5	6.0	2	21	21	6.0	1310.11.2.060	50
Pg 11	5.5	7.5	2	24	23	6.0	1310.11.2.075	50
Pg 11	3.5	5.0	3	21	21	6.0	1310.11.3.050	50
Pg 13	3.5	5.0	2	24	23	6.0	1310.13.2.050	50
Pg 13	4.5	6.0	2	24	23	6.0	1310.13.2.060	50
Pg 13	5.5	7.5	2	24	23	6.0	1310.13.2.075	50
Pg 13	3.5	5.0	3	24	23	6.0	1310.13.3.050	50
Pg 13	4.5	6.0	3	24	23	6.0	1310.13.3.060	50
Pg 13	5.2	6.5	3	24	23	6.0	1310.13.3.065	50
Pg 13	3.5	5.0	4	24	23	6.0	1310.13.4.050	50
Pg 13	4.5	6.0	4	24	23	6.0	1310.13.4.060	50
Pg 16	3.5	5.0	2	24	23	6.0	1310.16.2.050	50
Pg 16	4.5	6.0	2	24	23	6.0	1310.16.2.060	50
Pg 16	5.5	7.5	2	24	23	6.0	1310.16.2.075	50
Pg 16	6.7	9.0	2	30	28	6.0	1310.16.2.090	25
Pg 16	3.5	5.0	3	24	23	6.0	1310.16.3.050	50
Pg 16	4.5	6.0	3	24	23	6.0	1310.16.3.060	50
Pg 16	5.0	7.0	3	30	28	6.0	1310.16.3.070	25
Pg 16	3.5	5.0	4	24	23	6.0	1310.16.4.050	50
Pg 16	4.5	6.0	4	24	23	6.0	1310.16.4.060	50
Pg 16	5.5	7.0	4	30	28	6.0	1310.16.4.070	25
Pg 21	5.0	7.0	2	30	28	7.5	1310.21.2.070	25
Pg 21	6.7	9.0	2	30	28	7.5	1310.21.2.090	25
Pg 21	7.7	10.0	2	30	28	7.5	1310.21.2.100	25
Pg 21	9.0	11.5	2	36	28	7.5	1310.21.2.115	25
Pg 21	5.5	7.0	3	30	28	7.5	1310.21.3.070	25
Pg 21	6.8	9.0	3	30	28	7.5	1310.21.3.090	25
Pg 21	8.5	10.5	3	36	28	7.5	1310.21.3.105	25
Pg 21	5.5	7.0	4	30	28	7.5	1310.21.4.070	25
Pg 21	7.0	9.0	4	36	28	7.5	1310.21.4.090	25
Pg 21	4.8	6.0	6	30	28	7.5	1310.21.6.060	25
Pg 21	5.8	7.0	6	36	28	7.5	1310.21.6.070	25
Pg 29	7.5	9.0	3	38	28	8.0	1310.29.3.090	25

Weitere Ausführungen und Anschlussgewinde auf Anfrage

Further versions and entry threads are available upon request.

Erhältlich mit Dichteinsatz gemäss EN 45545. Bei Anfragen oder Bestellung bitte ein F vor die Artikelnummer setzen.

Available with sealing inserts conformity with EN 45545. When placing an inquiry, prefix the article number by the capital F.

Kabelverschraubungen Progress® Messing für mehrere Kabel Cable glands Progress® nickel-plated brass for installation of multiple cables

Langes Anschlussgewinde Pg | Long entry thread Pg

Material: Messing vernickelt
Dichtung: TPE
O-Ring : NBR
Einsatztemperatur: -40°C / +100°C
Schutzart: IP 68

Material: Nickel-plated brass
Seal: TPE
O-ring : NBR
Temperature range: -40°C / +100°C
Protection class: IP 68

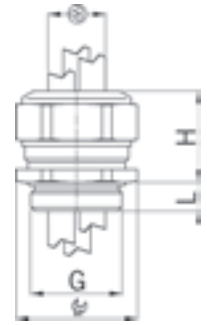

Progress MS Multi

Einteiliger Dichteinsatz nicht durchgehend isolierend		One-piece sealing insert not overall length insulated				Art.-Nr. Art. No.		
G	>Ø< min mm	>Ø< max mm			H mm	L mm		
Pg 9	2.0	3.0	2	18	22	10	1311.09.2.030	50
Pg 9	2.5	4.0	2	18	22	10	1311.09.2.040	50
Pg 9	3.5	5.0	2	18	22	10	1311.09.2.050	50
Pg 11	3.5	5.0	2	21	21	10	1311.11.2.050	50
Pg 11	4.5	6.0	2	21	21	10	1311.11.2.060	50
Pg 11	5.5	7.5	2	24	23	10	1311.11.2.075	50
Pg 11	3.5	5.0	3	21	21	10	1311.11.3.050	50
Pg 13	3.5	5.0	2	24	23	10	1311.13.2.050	50
Pg 13	4.5	6.0	2	24	23	10	1311.13.2.060	50
Pg 13	5.5	7.5	2	24	23	10	1311.13.2.075	50
Pg 13	3.5	5.0	3	24	23	10	1311.13.3.050	50
Pg 13	4.5	6.0	3	24	23	10	1311.13.3.060	50
Pg 13	5.2	6.5	3	24	23	10	1311.13.3.065	50
Pg 13	3.5	5.0	4	24	23	10	1311.13.4.050	50
Pg 13	4.5	6.0	4	24	23	10	1311.13.4.060	50
Pg 16	3.5	5.0	2	24	23	10	1311.16.2.050	50
Pg 16	4.5	6.0	2	24	23	10	1311.16.2.060	50
Pg 16	5.5	7.5	2	24	23	10	1311.16.2.075	50
Pg 16	6.7	9.0	2	30	28	10	1311.16.2.090	25
Pg 16	3.5	5.0	3	24	23	10	1311.16.3.050	50
Pg 16	4.5	6.0	3	24	23	10	1311.16.3.060	50
Pg 16	5.0	7.0	3	30	28	10	1311.16.3.070	25
Pg 16	3.5	5.0	4	24	23	10	1311.16.4.050	50
Pg 16	4.5	6.0	4	24	23	10	1311.16.4.060	50
Pg 16	5.5	7.0	4	30	28	10	1311.16.4.070	25
Pg 21	5.0	7.0	2	30	28	12	1311.21.2.070	25
Pg 21	6.7	9.0	2	30	28	12	1311.21.2.090	25
Pg 21	7.7	10.0	2	30	28	12	1311.21.2.100	25
Pg 21	9.0	11.5	2	36	28	12	1311.21.2.115	25
Pg 21	5.5	7.0	3	30	28	12	1311.21.3.070	25
Pg 21	6.8	9.0	3	30	28	12	1311.21.3.090	25
Pg 21	8.5	10.5	3	36	28	12	1311.21.3.105	25
Pg 21	5.5	7.0	4	30	28	12	1311.21.4.070	25
Pg 21	7.0	9.0	4	36	28	12	1311.21.4.090	25
Pg 21	4.8	6.0	6	30	28	12	1311.21.6.060	25
Pg 21	5.8	7.0	6	36	28	12	1311.21.6.070	25
Pg 29	7.5	9.0	3	38	28	12	1311.29.3.090	25



Kabelverschraubungen Progress® Messing mit Dichteinsatz ohne Bohrung

Cable glands Progress® nickel-plated brass with sealing insert without drilled hole

Kurzes Anschlussgewinde metrisch | Short entry thread metric

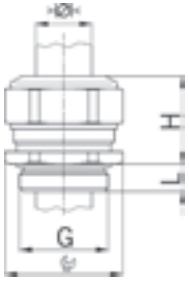

Material: Messing vernickelt
 Dichtung: NBR, ohne Bohrung
 O-Ring: NBR
 Einsatztemperatur: -40°C / +100°C
 Schutzart: IP 68 (bis 10 bar)
 Weitere Schutzart: IP 69K

Material: Nickel-plated brass
 Seal: NBR, without drilled hole
 O-ring: NBR
 Temperature range: -40°C / +100°C
 Protection class: IP 68 (up to 10 bar)
 Further protection: IP 69K



Progress MS NBR



Einteiliger Dichteinsatz ohne Bohrung
 nicht durchgehend isolierend

One-piece solid sealing insert
 not overall length insulated

G	> Ø < max mm	PG	H mm	L mm	i info	Art.-Nr. Art. No.	
M6x1.0	3.5	8	12	5	1	1000.06.30	50
M8x1.25	5.0	11	14	5	1	1000.08.30	50
M10x1.5	6.0	13	15	5	1	1000.10.30	50
M12x1.5	8.0	15	17	5	-	1000.12.30	50
M16x1.5	10.5	18	22	5	-	1000.17.30	50
M20x1.5	15.0	24	23	6	-	1000.20.30	50
M25x1.5	20.5	30	28	7	-	1000.25.30	25
M32x1.5	25.5	36	28	8	-	1000.32.30	25
M40x1.5	33.0	46	31	8	-	1000.40.30	10
M50x1.5	42.0	55	34	9	-	1000.50.30	10
M63x1.5	52.0	70	37	10	-	1000.63.30	5

1 = Metrisches Regelgewinde

1 = Metric coarse-pitch thread

Erhältlich mit Dichteinsatz gemäss EN 45545. Bei Anfragen oder Bestellung bitte ein F vor die Artikelnummer setzen.

Available with sealing inserts conformity with EN 45545. When placing an inquiry, prefix the article number by the capital F.

Technischer Hinweis

Dichteinsätze ohne Bohrung lassen sich gut bearbeiten, wenn sie vorher auf mindestens -25°C gefroren wurden.

Technical note

When frozen to at least -25°C, the solid sealing inserts are easy to drill.

Kurzes Anschlussgewinde Pg | Short entry thread Pg



Progress MS NBR



Einteiliger Dichteinsatz ohne Bohrung
 nicht durchgehend isolierend

One-piece solid sealing insert
 not overall length insulated

G	> Ø < max mm	PG	H mm	L mm	Art.-Nr. Art. No.	
Pg 7	8.0	15	17	6.0	1000.07.30	50
Pg 9	10.5	18	22	6.0	1000.09.30	50
Pg 11	12.0	21	21	6.0	1000.11.30	50
Pg 11	15.0	24	23	6.0	1000.11.20.30	50
Pg 13	15.0	24	23	6.0	1000.13.30	50
Pg 16	15.0	24	23	6.0	1000.16.30	50
Pg 16	18.5	30	28	6.0	1000.16.25.30	25
Pg 21	20.5	30	28	7.5	1000.21.30	25
Pg 21	23.0	36	28	7.5	1000.21.32.30	25
Pg 29	27.5	38	28	8.0	1000.29.30	25
Pg 29	33.0	46	31	8.0	1000.29.40.30	25
Pg 36	35.0	50	32	8.0	1000.36.30	10
Pg 36	42.0	55	34	8.0	1000.36.50.30	10
Pg 42	42.0	55	34	10.0	1000.42.30	10
Pg 48	49.0	65	37	11.0	1000.48.30	10

Erhältlich mit Dichteinsatz gemäss EN 45545. Bei Anfragen oder Bestellung bitte ein F vor die Artikelnummer setzen.

Available with sealing inserts conformity with EN 45545. When placing an inquiry, prefix the article number by the capital F.

Technischer Hinweis

Dichteinsätze ohne Bohrung lassen sich gut bearbeiten, wenn sie vorher auf mindestens -25°C gefroren wurden.

Technical note

When frozen to at least -25°C, the solid sealing inserts are easy to drill.

Kabelverschraubungen Progress® Messing mit Dichteinsatz ohne Bohrung

Cable glands Progress® nickel-plated brass with sealing insert without drilled hole

Kurzes Anschlussgewinde metrisch | Short entry thread metric

Material: Messing vernickelt
 Dichtung: FPM, ohne Bohrung
 O-Ring : FPM
 Einsatztemperatur: -40°C / +200°C
 Schutzart: IP 68 (bis 10 bar)
 Weitere Schutzart: IP 69K

Material: Nickel-plated brass
 Seal: FPM, without drilled hole
 O-ring : FPM
 Temperature range: -40°C / +200°C
 Protection class: IP 68 (up to 10 bar)
 Further protection: IP 69K

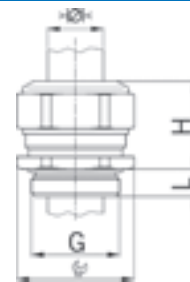

Progress MS FPM



Für hohe Temperaturen
 Einteiliger Dichteinsatz ohne Bohrung
 nicht durchgehend isolierend

For high temperature applications
 One-piece solid sealing insert
 not overall length insulated

G	>Ø< max mm	IC	H mm	L mm	i info	Art.-Nr. Art. No.	
M6x1.0	3.5	8	12	5	1	1000.06.30.91	50
M8x1.25	5.0	11	14	5	1	1000.08.30.91	50
M10x1.5	6.0	13	15	5	1	1000.10.30.91	50
M12x1.5	8.0	15	17	5	-	1000.12.30.91	50
M16x1.5	10.5	18	22	5	-	1000.17.30.91	50
M20x1.5	15.0	24	23	6	-	1000.20.30.91	50
M25x1.5	20.5	30	28	7	-	1000.25.30.91	25
M32x1.5	25.5	36	28	8	-	1000.32.30.91	25
M40x1.5	33.0	46	31	8	-	1000.40.30.91	10
M50x1.5	42.0	55	34	9	-	1000.50.30.91	10
M63x1.5	52.0	70	37	10	-	1000.63.30.91	5

1 = Metrisches Regelgewinde

1 = Metric coarse-pitch thread

Technischer Hinweis

Dichteinsätze ohne Bohrung lassen sich gut bearbeiten, wenn sie vorher auf mindestens -25°C gefroren wurden.

Technical note

When frozen to at least -25°C, the solid sealing inserts are easy to drill.



Kurzes Anschlussgewinde Pg | Short entry thread Pg

Progress MS FPM



Für hohe Temperaturen
 Einteiliger Dichteinsatz ohne Bohrung
 nicht durchgehend isolierend

For high temperature applications
 One-piece solid sealing insert
 not overall length insulated

G	>Ø< max mm	IC	H mm	L mm	Art.-Nr. Art. No.	
Pg 7	8.0	15	17	6.0	1000.07.30.91	50
Pg 9	10.5	18	22	6.0	1000.09.30.91	50
Pg 11	12.0	21	21	6.0	1000.11.30.91	50
Pg 11	15.0	24	23	6.0	1000.11.20.30.91	50
Pg 13	15.0	24	23	6.0	1000.13.30.91	50
Pg 16	15.0	24	23	6.0	1000.16.30.91	50
Pg 16	18.5	30	28	6.0	1000.16.25.30.91	25
Pg 21	20.5	30	28	7.5	1000.21.30.91	25
Pg 21	23.0	36	28	7.5	1000.21.32.30.91	25
Pg 29	27.5	38	28	8.0	1000.29.30.91	25
Pg 29	33.0	46	31	8.0	1000.29.40.30.91	25
Pg 36	35.0	50	32	8.0	1000.36.30.91	10
Pg 36	42.0	55	34	8.0	1000.36.50.30.91	10
Pg 42	42.0	55	34	10.0	1000.42.30.91	10
Pg 48	49.0	65	37	11.0	1000.48.30.91	10

Technischer Hinweis

Dichteinsätze ohne Bohrung lassen sich gut bearbeiten, wenn sie vorher auf mindestens -25°C gefroren wurden.

Technical note

When frozen to at least -25°C, the solid sealing inserts are easy to drill.



Kabelverschraubungen Progress® Messing für Flachkabel

Cable glands Progress® nickel-plated brass for flat cables

Kurzes Anschlussgewinde metrisch | Short entry thread metric

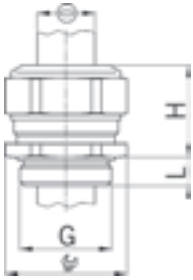

Material: Messing vernickelt
 Dichtung: TPE
 O-Ring : NBR
 Zugentlastung: Ausführung A
 Einsatztemperatur: -40°C / +100°C
 Schutzart: IP 68

Material: Nickel-plated brass
 Seal: TPE
 O-ring : NBR
 Strain relief: Version A
 Temperature range: -40°C / +100°C
 Protection class: IP 68



Progress MS FK



Einteiliger Dichteinsatz
 nicht durchgehend isolierend

One-piece sealing insert
 not overall length insulated

G	min mm	max mm		H mm	L mm	Art.-Nr. Art. No.	
M16x1.5	7.3x2.5	9.0x4.2	18	22	5	1300.17.090.042	50
M20x1.5	10.5x2.5	13.0x5.0	24	23	6	1300.20.130.050	50
M20x1.5	12.5x2.5	15.0x5.0	24	23	6	1300.20.150.050	50
M25x1.5	16.0x4.0	19.0x7.0	30	28	7	1300.25.190.070	25
M32x1.5	19.0x3.0	22.0x6.0	36	28	8	1300.32.220.060	25
M32x1.5	19.0x5.0	22.0x8.0	36	28	8	1300.32.220.080	25
M40x1.5	23.0x4.0	26.0x7.0	46	31	8	1300.40.260.070	10
M40x1.5	23.5x6.0	26.5x9.0	46	31	8	1300.40.265.090	10
M40x1.5	25.0x3.0	28.0x6.0	46	31	8	1300.40.280.060	10
M40x1.5	27.0x7.0	30.0x10.0	46	31	8	1300.40.300.100	10
M40x1.5	29.0x6.0	32.0x9.0	46	31	8	1300.40.320.090	10
M40x1.5	30.0x3.5	33.0x6.5	46	31	8	1300.40.330.065	10
M50x1.5	31.0x8.5	34.0x11.5	55	34	9	1300.50.340.115	10
M50x1.5	34.0x4.0	37.0x7.0	55	34	9	1300.50.370.070	10
M50x1.5	36.5x2.5	40.0x6.0	55	34	9	1300.50.400.060	10
M50x1.5	36.5x10.0	40.0x13.5	55	34	9	1300.50.400.135	10
M50x1.5	38.5x10.5	42.0x14.0	55	34	9	1300.50.420.140	10
M63x1.5	42.0x10.0	46.0x14.0	70	37	10	1300.63.460.140	5
M63x1.5	42.5x2.0	46.5x6.0	70	37	10	1300.63.465.060	5

Erhältlich mit Dichteinsatz gemäss EN 45545. Bei Anfragen oder Bestellung bitte ein F vor die Artikelnummer setzen.

Available with sealing inserts conformity with EN 45545. When placing an inquiry, prefix the article number by the capital F.

Kabelverschraubungen Progress® Messing für Flachkabel Cable glands Progress® nickel-plated brass for flat cables

Langes Anschlussgewinde metrisch | Long entry thread metric

Material: Messing vernickelt
Dichtung: TPE
O-Ring : NBR
Zugentlastung: Ausführung A
Einsatztemperatur: -40°C / +100°C
Schutzart: IP 68

Material: Nickel-plated brass
Seal: TPE
O-ring : NBR
Strain relief: Version A
Temperature range: -40°C / +100°C
Protection class: IP 68

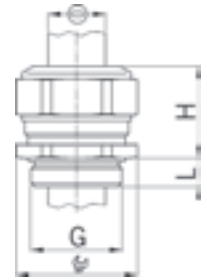

Progress MS FK



Einteiliger Dichteinsatz
nicht durchgehend isolierend

One-piece sealing insert
not overall length insulated

G	min mm	max mm		H mm	L mm	Art.-Nr. Art. No.	
M16x1.5	7.3x2.5	9.0x4.2	18	22	10	1301.17.090.042	50
M20x1.5	10.5x2.5	13.0x5.0	24	23	10	1301.20.130.050	50
M20x1.5	12.5x2.5	15.0x5.0	24	23	10	1301.20.150.050	50
M25x1.5	16.0x4.0	19.0x7.0	30	28	11	1301.25.190.070	25
M32x1.5	19.0x3.0	22.0x6.0	36	28	13	1301.32.220.060	25
M32x1.5	19.0x5.0	22.0x8.0	36	28	13	1301.32.220.080	25
M40x1.5	23.0x4.0	26.0x7.0	46	31	13	1301.40.260.070	10
M40x1.5	23.5x6.0	26.5x9.0	46	31	13	1301.40.265.090	10
M40x1.5	25.0x3.0	28.0x6.0	46	31	13	1301.40.280.060	10
M40x1.5	27.0x7.0	30.0x10.0	46	31	13	1301.40.300.100	10
M40x1.5	29.0x6.0	32.0x9.0	46	31	13	1301.40.320.090	10
M40x1.5	30.0x3.5	33.0x6.5	46	31	13	1301.40.330.065	10
M50x1.5	31.0x8.5	34.0x11.5	55	34	14	1301.50.340.115	10
M50x1.5	34.0x4.0	37.0x7.0	55	34	14	1301.50.370.070	10
M50x1.5	36.5x2.5	40.0x6.0	55	34	14	1301.50.400.060	10
M50x1.5	36.5x10.0	40.0x13.5	55	34	14	1301.50.400.135	10
M50x1.5	38.5x10.5	42.0x14.0	55	34	14	1301.50.420.140	10
M63x1.5	42.0x10.0	46.0x14.0	70	37	14	1301.63.460.140	5
M63x1.5	42.5x2.0	46.5x6.0	70	37	14	1301.63.465.060	5

Erhältlich mit Dichteinsatz gemäss EN 45545. Bei Anfragen oder Bestellung bitte ein F vor die Artikelnummer setzen.

Available with sealing inserts conformity with EN 45545. When placing an inquiry, prefix the article number by the capital F.



Kabelverschraubungen Progress® Messing für Flachkabel

Cable glands Progress® nickel-plated brass for flat cables

Kurzes Anschlussgewinde Pg | Short entry thread Pg

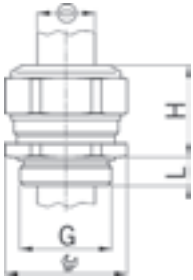

Material: Messing vernickelt
 Dichtung: TPE
 O-Ring : NBR
 Einsatztemperatur: -40°C / +100°C
 Schutzart: IP 68

Material: Nickel-plated brass
 Seal: TPE
 O-ring : NBR
 Temperature range: -40°C / +100°C
 Protection class: IP 68



Progress MS FK

Einteiliger Dichteinsatz nicht durchgehend isolierend		One-piece sealing insert not overall length insulated				Art.-Nr. Art. No.		
G	min mm	max mm		H mm	L mm			
Pg 9	7.3x2.5	9.0x4.2	18	22	6.0		1300.09.090.042	50
Pg 13	10.5x2.5	13.0x5.0	24	23	6.0		1300.13.130.050	50
Pg 13	12.5x2.5	15.0x5.0	24	23	6.0		1300.13.150.050	50
Pg 16	10.5x2.5	13.0x5.0	24	23	6.0		1300.16.130.050	50
Pg 16	12.5x2.5	15.0x5.0	24	23	6.0		1300.16.150.050	50
Pg 21	16.0x4.0	19.0x7.0	30	28	7.5		1300.21.190.070	25
Pg 21	19.0x3.0	22.0x6.0	36	28	7.5		1300.21.220.060	25
Pg 21	19.0x5.0	22.0x8.0	36	28	7.5		1300.21.220.080	25
Pg 29	23.0x4.0	26.0x7.0	46	31	8.0		1300.29.260.070	25
Pg 29	23.5x6.0	26.5x9.0	46	31	8.0		1300.29.265.090	25
Pg 29	25.0x3.0	28.0x6.0	46	31	8.0		1300.29.280.060	25
Pg 29	27.0x7.0	30.0x10.0	46	31	8.0		1300.29.300.100	25
Pg 29	29.0x6.0	32.0x9.0	46	31	8.0		1300.29.320.090	25
Pg 29	30.0x3.5	33.0x6.5	46	31	8.0		1300.29.330.065	25
Pg 42	31.0x8.5	34.0x11.5	55	34	10.0		1300.42.340.115	10
Pg 42	34.0x4.0	37.0x7.0	55	34	10.0		1300.42.370.070	10
Pg 42	36.5x2.5	40.0x6.0	55	34	10.0		1300.42.400.060	10
Pg 42	36.5x10.0	40.0x13.5	55	34	10.0		1300.42.400.135	10
Pg 42	38.5x10.5	42.0x14.0	55	34	10.0		1300.42.420.140	10
Pg 48	42.0x10.0	46.0x14.0	65	37	11.0		1300.48.460.140	10
Pg 48	42.5x2.0	46.5x6.0	65	37	11.0		1300.48.465.060	10

Langes Anschlussgewinde Pg | Long entry thread Pg



Progress MS FK

Einteiliger Dichteinsatz nicht durchgehend isolierend		One-piece sealing insert not overall length insulated				Art.-Nr. Art. No.		
G	min mm	max mm		H mm	L mm			
Pg 9	7.3x2.5	9.0x4.2	18	22	10		1301.09.090.042	50
Pg 13	10.5x2.5	13.0x5.0	24	23	10		1301.13.130.050	50
Pg 13	12.5x2.5	15.0x5.0	24	23	10		1301.13.150.050	50
Pg 16	10.5x2.5	13.0x5.0	24	23	10		1301.16.130.050	50
Pg 16	12.5x2.5	15.0x5.0	24	23	10		1301.16.150.050	50
Pg 21	16.0x4.0	19.0x7.0	30	28	12		1301.21.190.070	25
Pg 21	19.0x3.0	22.0x6.0	36	28	12		1301.21.220.060	25
Pg 21	19.0x5.0	22.0x8.0	36	28	12		1301.21.220.080	25
Pg 29	23.0x4.0	26.0x7.0	46	31	12		1301.29.260.070	25
Pg 29	23.5x6.0	26.5x9.0	46	31	12		1301.29.265.090	25
Pg 29	25.0x3.0	28.0x6.0	46	31	12		1301.29.280.060	25
Pg 29	27.0x7.0	30.0x10.0	46	31	12		1301.29.300.100	25
Pg 29	29.0x6.0	32.0x9.0	46	31	12		1301.29.320.090	25
Pg 29	30.0x3.5	33.0x6.5	46	31	12		1301.29.330.065	25
Pg 42	31.0x8.5	34.0x11.5	55	34	15		1301.42.340.115	10
Pg 42	34.0x4.0	37.0x7.0	55	34	15		1301.42.370.070	10
Pg 42	36.5x2.5	40.0x6.0	55	34	15		1301.42.400.060	10
Pg 42	36.5x10.0	40.0x13.5	55	34	15		1301.42.400.135	10
Pg 42	38.5x10.5	42.0x14.0	55	34	15		1301.42.420.140	10
Pg 48	42.0x10.0	46.0x14.0	65	37	15		1301.48.460.140	10
Pg 48	42.5x2.0	46.5x6.0	65	37	15		1301.48.465.060	10

Kabelverschraubungen Progress® Messing mit speziellem Anschlussgewinde

Cable glands Progress® nickel-plated brass with special entry thread

Speziell langes Anschlussgewinde metrisch | Extra-long entry thread metric

Material: Messing vernickelt
 Dichtung: TPE
 O-Ring : NBR
 Zugentlastung: Ausführung A
 Einsatztemperatur: -40°C / +100°C
 Schutzart: IP 68 (bis 10 bar)
 Weitere Schutzart: IP 69K

Material: Nickel-plated brass
 Seal: TPE
 O-ring : NBR
 Strain relief: Version A
 Temperature range: -40°C / +100°C
 Protection class: IP 68 (up to 10 bar)
 Further protection: IP 69K

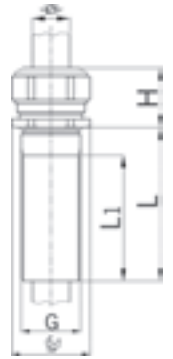

Progress MS L



Anschlussgewinde metrisch 50 mm lang
 Zweiteiliger Dichteinsatz
 nicht durchgehend isolierend

Entry thread metric, 50 mm long
 Two-piece sealing insert
 not overall length insulated

G	> Ø < min mm	> Ø < max mm		H mm	L1 mm	L mm	Art.-Nr. Art. No.	
M16x1.5	6.0	10.5	24/18	22	40	50	1100.17.50	10
M20x1.5	8.0	15.0	30/24	23	40	50	1100.20.50	10
M25x1.5	12.5	20.5	36/30	28	40	50	1100.25.50	10
M32x1.5	17.0	25.5	46/36	28	40	50	1100.32.50	10
M40x1.5	24.0	33.0	55/46	31	40	50	1100.40.50	10

Weitere Abmessungen auf Anfrage

Further dimensions upon request



Speziell langes Anschlussgewinde Pg | Specially long entry thread Pg

Material: Messing vernickelt
 Dichtung: TPE
 O-Ring : NBR
 Einsatztemperatur: -40°C / +100°C
 Schutzart: IP 68 (bis 10 bar)
 Weitere Schutzart: IP 69K

Material: Nickel-plated brass
 Seal: TPE
 O-ring : NBR
 Temperature range: -40°C / +100°C
 Protection class: IP 68 (up to 10 bar)
 Further protection: IP 69K

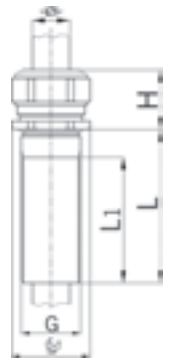

Progress MS L



Anschlussgewinde Pg 50 mm lang
 Zweiteiliger Dichteinsatz
 nicht durchgehend isolierend

Entry thread Pg, 50 mm long
 Two-piece sealing insert
 not overall length insulated

G	> Ø < min mm	> Ø < max mm		H mm	L1 mm	L mm	Art.-Nr. Art. No.	
Pg 11	5.5	12.0	27/21	21	40	50	1100.11.50	10
Pg 13	8.0	15.0	30/24	23	40	50	1100.13.50	10
Pg 16	8.0	15.0	30/24	23	40	50	1100.16.50	10
Pg 21	12.5	20.5	38/30	28	40	50	1100.21.50	10
Pg 29	19.0	27.5	46/38	28	40	50	1100.29.50	10

Weitere Abmessungen auf Anfrage

Further dimensions upon request



Kabelverschraubungen Progress® Messing mit speziellem Anschlussgewinde

Cable glands Progress® nickel-plated brass with special entry thread

Mit Innengewinde metrisch | With inner thread metric

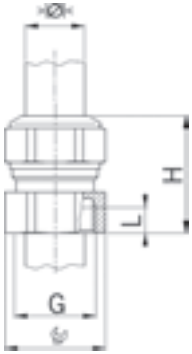

Material: Messing vernickelt
 Dichtung: TPE
 Zugentlastung: Ausführung A
 Einsatztemperatur: -40°C / +100°C
 Schutzart: IP 68, wenn Anschlussgewinde abgedichtet
 Weitere Schutzart: IP 69K

Material: Nickel-plated brass
 Seal: TPE
 Strain relief: Version A
 Temperature range: -40°C / +100°C
 Protection class: IP 68, if the entry thread is sealed
 Further protection: IP 69K



Progress MS IG



Anschluss mit Innengewinde metrisch
 Zweiteiliger Dichteinsatz
 nicht durchgehend isolierend

Internal thread metric
 Two-piece sealing insert
 not overall length insulated

G	> Ø < min mm	> Ø < max mm		H mm	L mm	Art.-Nr. Art. No.	
M16x1.5	6.0	10.5	18	28	6	1400.17	25
M20x1.5	8.0	15.0	24	31	6	1400.20	25
M25x1.5	12.5	20.5	30	40	10	1400.25	25

Erhältlich mit Dichteinsatz gemäss EN 45545. Bei Anfragen oder Bestellung bitte ein F vor die Artikelnummer setzen.

Available with sealing inserts conformity with EN 45545. When placing an inquiry, prefix the article number by the capital F.

Mit Innengewinde Pg | With inner thread Pg

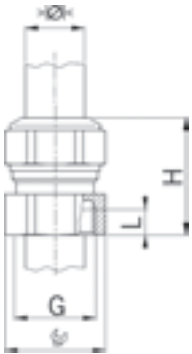

Material: Messing vernickelt
 Dichtung: TPE
 Einsatztemperatur: -40°C / +100°C
 Schutzart: IP 68, wenn Anschlussgewinde abgedichtet
 Weitere Schutzart: IP 69K

Material: Nickel-plated brass
 Seal: TPE
 Temperature range: -40°C / +100°C
 Protection class: IP 68, if the entry thread is sealed
 Further protection: IP 69K



Progress MS IG



Anschluss mit Innengewinde Pg
 Zweiteiliger Dichteinsatz
 nicht durchgehend isolierend

Internal thread Pg
 Two-piece sealing insert
 not overall length insulated

G	> Ø < min mm	> Ø < max mm		H mm	L mm	Art.-Nr. Art. No.	
Pg 11	5.5	12.0	21	28	6	1400.11	25
Pg 16	8.0	15.0	24	31	6	1400.16	25
Pg 21	12.5	20.5	30	40	10	1400.21	25

Erhältlich mit Dichteinsatz gemäss EN 45545. Bei Anfragen oder Bestellung bitte ein F vor die Artikelnummer setzen.

Available with sealing inserts conformity with EN 45545. When placing an inquiry, prefix the article number by the capital F.

Kabelverschraubungen Progress® Messing mit Knickschutzfeder Cable glands Progress® nickel-plated brass with antikink spring

Kurzes Anschlussgewinde metrisch | Short entry thread metric

Kabelverschraubungen Progress® Messing mit Knickschutztüle EPDM

Material:	Messing vernickelt
Dichtung:	NBR
O-Ring :	NBR
Knickschutztüle:	EPDM
Zugentlastung:	Ausführung A
Einsatztemperatur:	-40°C / +100°C
Schutzart:	IP 68
Weitere Schutzart:	IP 69K

Cable glands Progress® nickel-plated brass with antikink nozzle EPDM

Material:	Nickel-plated brass
Seal:	NBR
O-ring :	NBR
antikink nozzle:	EPDM
Strain relief:	Version A
Temperature range:	-40°C / +100°C
Protection class:	IP 68
Further protection:	IP 69K

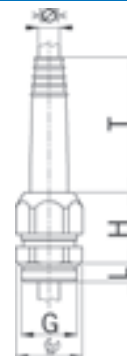

Einteiliger Dichteinsatz
nicht durchgehend isolierend

One-piece sealing insert
not overall length insulated

G	> Ø < min mm	> Ø < max mm		H mm	T mm	L mm	i info	Art.-Nr. Art. No.	
M8x1.25	3.8	4.8	11	12	25	6	1	1008.52	50
M10x1.5	4.0	6.0	16	20	35	6	1	1010.52	50
M12x1.5	4.0	6.0	16	20	35	6	-	1012.52	50
M16x1.5	6.0	8.8	20	24	45	6	-	1017.52	50
M20x1.5	9.0	11.0	24	28	65	6	-	1020.51	25
M20x1.5	10.5	13.0	24	28	73	6	-	1020.52	25
M25x1.5	13.0	16.5	32	33	92	7	-	1025.52	10

1 = Metrisches Regelgewinde

1 = Metric coarse-pitch thread



Kurzes Anschlussgewinde Pg | Short entry thread Pg

Kabelverschraubungen Progress® Messing mit Knickschutztüle EPDM

Material:	Messing vernickelt
Dichtung:	NBR
O-Ring :	NBR
Knickschutztüle:	EPDM
Einsatztemperatur:	-40°C / +100°C
Schutzart:	IP 68
Weitere Schutzart:	IP 69K

Cable glands Progress® nickel-plated brass with antikink nozzle EPDM

Material:	Nickel-plated brass
Seal:	NBR
O-ring :	NBR
antikink nozzle:	EPDM
Temperature range:	-40°C / +100°C
Protection class:	IP 68
Further protection:	IP 69K

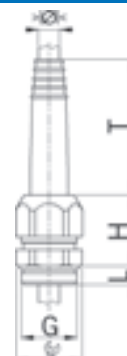

Einteiliger Dichteinsatz
nicht durchgehend isolierend

One-piece sealing insert
not overall length insulated

G	> Ø < min mm	> Ø < max mm		H mm	T mm	L mm	Art.-Nr. Art. No.	
Pg 7	4.0	6.0	16	20	35	6	1007.52	50
Pg 9	6.0	8.8	20	24	45	6	1009.52	50
Pg 11	6.0	8.8	20	24	45	6	1011.52	50
Pg 13	9.0	11.0	24	28	65	6	1013.51	25
Pg 13	10.5	13.0	24	28	73	6	1013.52	25
Pg 16	9.0	11.0	24	28	65	6	1016.51	25
Pg 16	10.5	13.0	24	28	73	6	1016.52	25
Pg 21	13.0	16.5	32	33	92	7.5	1021.51	10



Kabelverschraubungen Progress® Messing mit Knickschutzfeder

Cable glands Progress® nickel-plated brass with antikink spring

Kurzes Anschlussgewinde metrisch | Short entry thread metric



Material: Messing vernickelt
 Knickschutzfeder: Rostfreier Stahl A2
 Dichtung: TPE
 O-Ring : NBR
 Zugentlastung: Ausführung A
 Einsatztemperatur: -40°C / +100°C
 Schutzart: IP 68 (bis 10 bar)
 Weitere Schutzart: IP 69K

Material: Nickel-plated brass
 Antikink spring: Stainless steel A2
 Seal: TPE
 O-ring : NBR
 Strain relief: Version A
 Temperature range: -40°C / +100°C
 Protection class: IP 68 (up to 10 bar)
 Further protection: IP 69K



Progress MS FKN

Einteiliger Dichteinsatz
 durchgehend isolierend

One-piece sealing insert
 overall length insulated

G	>Ø< min mm	>Ø< max mm	IP	H mm	L mm	i info	Art.-Nr. Art. No.	
M8x1.25	2.5	3.0	11	49	5	1	1060.08.52.030	10
M8x1.25	3.5	4.0	11	49	5	1	1060.08.52.040	10
M10x1.5	3.0	4.0	13	52	5	1	1060.10.52.040	10
M10x1.5	4.0	6.0	13	52	5	1	1060.10.52.060	10
M12x1.5	3.5	5.0	15	57	5	-	1060.12.52.050	10
M12x1.5	5.0	6.5	15	57	5	-	1060.12.52.065	10
M12x1.5	6.5	7.5	15	57	5	-	1060.12.52.075	10
M16x1.5	4.5	6.0	18	66	5	-	1060.17.52.060	10
M16x1.5	6.0	8.0	18	66	5	-	1060.17.52.080	10
M16x1.5	8.0	10.5	18	66	5	-	1060.17.52.105	10
M20x1.5	6.0	8.0	24	86	6	-	1060.20.52.080	10
M20x1.5	8.0	11.0	24	86	6	-	1060.20.52.110	10
M20x1.5	11.0	14.5	24	86	6	-	1060.20.52.145	10
M25x1.5	9.5	12.5	30	99	7	-	1060.25.52.125	10
M25x1.5	12.5	16.0	30	99	7	-	1060.25.52.160	10
M25x1.5	16.0	19.0	30	99	7	-	1060.25.52.190	10
M32x1.5	17.0	21.0	36	109	8	-	1060.32.52.210	5
M32x1.5	21.0	24.5	36	109	8	-	1060.32.52.245	5

1 = Metrisches Regelgewinde

1 = Metric coarse-pitch thread

Erhältlich mit Dichteinsatz gemäss EN 45545. Bei Anfragen oder Bestellung bitte ein F vor die Artikelnummer setzen.

Available with sealing inserts conformity with EN 45545. When placing an inquiry, prefix the article number by the capital F.

Auf Anfrage lieferbar:

- Kurzes Anschlussgewinde mit kurzem ein- oder zweiseitigem Dichteinsatz.
- Langes Anschlussgewinde mit kurzem oder durchgehend isolierendem ein- oder zweiseitigem Dichteinsatz.

Available on request:

- Short entry thread with short one-piece or two-piece sealing insert.
- Long entry thread with short or full-length insulating one-piece or two-piece sealing insert.



Progress MS FKN

Zweiseitiger Dichteinsatz
 durchgehend isolierend

Two-piece sealing insert
 overall length insulated

G	>Ø< min mm	>Ø< max mm	IP	H mm	L mm	Art.-Nr. Art. No.	
M16x1.5	6.0	10.5	18	66	5	1060.17.52	10
M20x1.5	8.0	14.5	24	86	6	1060.20.52	10
M25x1.5	12.5	19.0	30	99	7	1060.25.52	10
M32x1.5	17.0	24.5	36	109	8	1060.32.52	5

Erhältlich mit Dichteinsatz gemäss EN 45545. Bei Anfragen oder Bestellung bitte ein F vor die Artikelnummer setzen.

Available with sealing inserts conformity with EN 45545. When placing an inquiry, prefix the article number by the capital F.

Auf Anfrage lieferbar:

- Kurzes Anschlussgewinde mit kurzem ein- oder zweiseitigem Dichteinsatz.
- Langes Anschlussgewinde mit kurzem oder durchgehend isolierendem ein- oder zweiseitigem Dichteinsatz.

Available on request:

- Short entry thread with short one-piece or two-piece sealing insert.
- Long entry thread with short or full-length insulating one-piece or two-piece sealing insert.

Kabelverschraubungen Progress® Messing mit Knickschutzfeder

Cable glands Progress® nickel-plated brass with antikink spring

Kurzes Anschlussgewinde Pg | Short entry thread Pg

Material: Messing vernickelt
 Knickschutzfeder: Rostfreier Stahl A2
 Dichtung: TPE
 O-Ring : NBR
 Einsatztemperatur: -40°C / +100°C
 Schutzart: IP 68 (bis 10 bar)
 Weitere Schutzart: IP 69K

Material: Nickel-plated brass
 Antikink spring: Stainless steel A2
 Seal: TPE
 O-ring : NBR
 Temperature range: -40°C / +100°C
 Protection class: IP 68 (up to 10 bar)
 Further protection: IP 69K

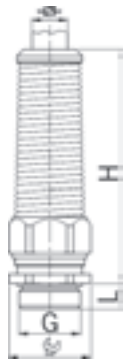

Progress MS FKN



Einteiliger Dichteinsatz
 durchgehend isolierend

One-piece sealing insert
 overall length insulated

G	$\gt;\varnothing<$ min mm	$\gt;\varnothing<$ max mm		H mm	L mm	Art.-Nr. Art. No.	
Pg 7	3.5	5.0	15	57	6	1060.07.52.050	10
Pg 7	5.0	6.5	15	57	6	1060.07.52.065	10
Pg 7	6.5	7.5	15	57	6	1060.07.52.075	10
Pg 9	4.5	6.0	18	66	6	1060.09.52.060	10
Pg 9	6.0	8.0	18	66	6	1060.09.52.080	10
Pg 9	8.0	10.5	18	66	6	1060.09.52.105	10
Pg 11	4.5	6.0	18/21	66	6	1060.11.52.060	10
Pg 11	6.0	8.0	18/21	66	6	1060.11.52.080	10
Pg 11	8.0	10.5	18/21	66	6	1060.11.52.105	10
Pg 13	6.0	8.0	24	86	6	1060.13.52.080	10
Pg 13	8.0	11.0	24	86	6	1060.13.52.110	10
Pg 13	11.0	14.5	24	86	6	1060.13.52.145	10
Pg 16	6.0	8.0	24	86	6	1060.16.52.080	10
Pg 16	8.0	11.0	24	86	6	1060.16.52.110	10
Pg 16	11.0	14.5	24	86	6	1060.16.52.145	10
Pg 21	9.5	12.5	30	99	7.5	1060.21.52.125	5
Pg 21	12.5	16.0	30	99	7.5	1060.21.52.160	5
Pg 21	16.0	19.0	30	99	7.5	1060.21.52.190	5



Erhältlich mit Dichteinsatz gemäss EN 45545. Bei Anfragen oder Bestellung bitte ein F vor die Artikelnummer setzen.

Available with sealing inserts conformity with EN 45545. When placing an inquiry, prefix the article number by the capital F.

Auf Anfrage lieferbar:

Available on request:

- Kurzes Anschlussgewinde mit kurzem ein- oder zweiteiligem Dichteinsatz.
- Langes Anschlussgewinde mit kurzem oder durchgehend isolierendem ein- oder zweiteiligem Dichteinsatz.

- Short entry thread with short one-piece or two-piece sealing insert.
- Long entry thread with short or full-length insulating one-piece or two-piece sealing insert.

Progress MS FKN



Zweiteiliger Dichteinsatz
 durchgehend isolierend

Two-piece sealing insert
 overall length insulated

G	$\gt;\varnothing<$ min mm	$\gt;\varnothing<$ max mm		H mm	L mm	Art.-Nr. Art. No.	
Pg 9	6.0	10.5	18	66	6	1060.09.52	10
Pg 11	6.0	10.5	18/21	66	6	1060.11.52	10
Pg 13	8.0	14.5	24	86	6	1060.13.52	10
Pg 16	8.0	14.5	24	86	6	1060.16.52	10
Pg 21	12.5	19.0	30	99	7.5	1060.21.52	5



Erhältlich mit Dichteinsatz gemäss EN 45545. Bei Anfragen oder Bestellung bitte ein F vor die Artikelnummer setzen.

Available with sealing inserts conformity with EN 45545. When placing an inquiry, prefix the article number by the capital F.

Auf Anfrage lieferbar:

Available on request:

- Kurzes Anschlussgewinde mit kurzem ein- oder zweiteiligem Dichteinsatz.
- Langes Anschlussgewinde mit kurzem oder durchgehend isolierendem ein- oder zweiteiligem Dichteinsatz.

- Short entry thread with short one-piece or two-piece sealing insert.
- Long entry thread with short or full-length insulating one-piece or two-piece sealing insert.

Kabelverschraubungen Progress® Messing mit Klemmbacken

Cable glands Progress® nickel-plated brass with clamps

Kurzes Anschlussgewinde metrisch | Short entry thread metric

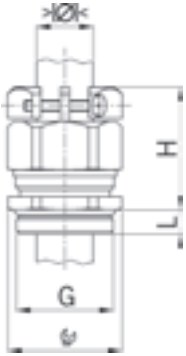

Material: Messing vernickelt
 Klemmschrauben: Rostfreier Stahl A2
 Dichtung: TPE
 O-Ring : NBR
 Zugentlastung: Ausführung B
 Einsatztemperatur: -40°C / +100°C
 Schutzart: IP 68 (bis 10 bar)
 Weitere Schutzart: IP 69K

Material: Nickel-plated brass
 Screws: Stainless steel A2
 Seal: TPE
 O-ring : NBR
 Strain relief: Version B
 Temperature range: -40°C / +100°C
 Protection class: IP 68 (up to 10 bar)
 Further protection: IP 69K

Progress MS KB



Einteiliger Dichteinsatz
 nicht durchgehend isolierend

One-piece sealing insert
 not overall length insulated

G	>Ø< min mm	>Ø< max mm	IC	H mm	L mm	i info	Art.-Nr. Art. No.	
M10x1.5	3.0	4.0	13/16	24	5	1	1800.10.03.040	50
M10x1.5	4.0	6.0	13/16	24	5	1	1800.10.03.060	50
M12x1.5	5.0	6.5	15/16	26	5	-	1800.12.03.065	50
M12x1.5	6.5	8.0	15/16	26	5	-	1800.12.03.080	50

1 = Metrisches Regelgewinde

1 = Metric coarse-pitch thread

Erhältlich mit Dichteinsatz gemäss EN 45545. Bei Anfragen oder Bestellung bitte ein F vor die Artikelnummer setzen.

Available with sealing inserts conformity with EN 45545. When placing an inquiry, prefix the article number by the capital F.

Progress MS KB



Zweiteiliger Dichteinsatz
 nicht durchgehend isolierend

Two-piece sealing insert
 not overall length insulated

G	>Ø< min mm	>Ø< max mm	IC	H mm	L mm	Art.-Nr. Art. No.	
M16x1.5	6.0	10.5	18/19	30	5	1800.17.03.105	50
M20x1.5	8.0	15.0	24	31	6	1800.20.03.150	50
M25x1.5	12.5	20.5	30	35	7	1800.25.03.205	25
M32x1.5	17.0	25.5	36	40	8	1800.32.03.255	25
M40x1.5	24.0	33.0	46	44	8	1800.40.03.330	10
M50x1.5	33.0	42.0	55	49	9	1800.50.03.410	10
M63x1.5	40.0	52.0	70	55	10	1800.63.03.520	5
M75x1.5	50.0	63.0	80	56	11	1800.75.03.630	1

Erhältlich mit Dichteinsatz gemäss EN 45545. Bei Anfragen oder Bestellung bitte ein F vor die Artikelnummer setzen.

Available with sealing inserts conformity with EN 45545. When placing an inquiry, prefix the article number by the capital F.

Kabelverschraubungen Progress® Messing mit Klemmbacken

Cable glands Progress® nickel-plated brass with clamps

Langes Anschlussgewinde metrisch | Long entry thread metric

Material: Messing vernickelt
 Klemmschrauben: Rostfreier Stahl A2
 Dichtung: TPE
 O-Ring : NBR
 Zugentlastung: Ausführung B
 Einsatztemperatur: -40°C / +100°C
 Schutzart: IP 68 (bis 10 bar)
 Weitere Schutzart: IP 69K

Material: Nickel-plated brass
 Screws: Stainless steel A2
 Seal: TPE
 O-ring : NBR
 Strain relief: Version B
 Temperature range: -40°C / +100°C
 Protection class: IP 68 (up to 10 bar)
 Further protection: IP 69K

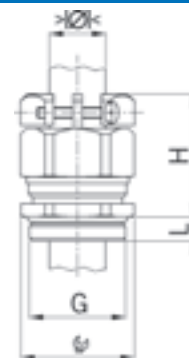

Progress MS KB



Einteiliger Dichteinsatz
 nicht durchgehend isolierend

One-piece sealing insert
 not overall length insulated

G	> Ø < min mm	> Ø < max mm		H mm	L mm	i info	Art.-Nr. Art. No.	
M10x1.5	3.0	4.0	13/16	24	10	1	1800.10.13.040	50
M10x1.5	4.0	6.0	13/16	24	10	1	1800.10.13.060	50
M12x1.5	5.0	6.5	15/16	26	10	-	1800.12.13.065	50
M12x1.5	6.5	8.0	15/16	26	10	-	1800.12.13.080	50

1 = Metrisches Regelgewinde

1 = Metric coarse-pitch thread

Erhältlich mit Dichteinsatz gemäss EN 45545. Bei Anfragen oder Bestellung bitte ein F vor die Artikelnummer setzen.

Available with sealing inserts conformity with EN 45545. When placing an inquiry, prefix the article number by the capital F.



Progress MS KB



Zweiteiliger Dichteinsatz
 nicht durchgehend isolierend

Two-piece sealing insert
 not overall length insulated

G	> Ø < min mm	> Ø < max mm		H mm	L mm	Art.-Nr. Art. No.	
M16x1.5	6.0	10.5	18/19	30	10	1800.17.13.105	50
M20x1.5	8.0	15.0	24	31	10	1800.20.13.150	50
M25x1.5	12.5	20.5	30	35	11	1800.25.13.205	25
M32x1.5	17.0	25.5	36	40	13	1800.32.13.255	25
M40x1.5	24.0	33.0	46	44	13	1800.40.13.330	10
M50x1.5	33.0	42.0	55	49	14	1800.50.13.410	10
M63x1.5	40.0	52.0	70	55	14	1800.63.13.520	5
M75x1.5	50.0	63.0	80	56	15	1800.75.13.630	1

Erhältlich mit Dichteinsatz gemäss EN 45545. Bei Anfragen oder Bestellung bitte ein F vor die Artikelnummer setzen.

Available with sealing inserts conformity with EN 45545. When placing an inquiry, prefix the article number by the capital F.



Kabelverschraubungen Progress® Messing mit Klemmbacken

Cable glands Progress® nickel-plated brass with clamps

Kurzes Anschlussgewinde Pg | Short entry thread Pg

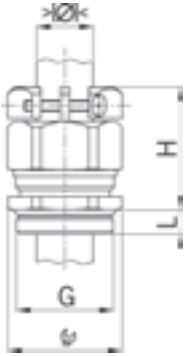

Material: Messing vernickelt
 Klemmschrauben: Rostfreier Stahl A2
 Dichtung: TPE
 O-Ring : NBR
 Einsatztemperatur: -40°C / +100°C
 Schutzart: IP 68 (bis 10 bar)
 Weitere Schutzart: IP 69K

Material: Nickel-plated brass
 Screws: Stainless steel A2
 Seal: TPE
 O-ring : NBR
 Temperature range: -40°C / +100°C
 Protection class: IP 68 (up to 10 bar)
 Further protection: IP 69K



Progress MS KB



Einteiliger Dichteinsatz
 nicht durchgehend isolierend

One-piece sealing insert
 not overall length insulated

G	>Ø< min mm	>Ø< max mm	IC	H mm	L mm	Art.-Nr. Art. No.	
Pg 7	5.0	6.5	15/16	26	6	1800.07.03.065	50
Pg 7	6.5	8.0	15/16	26	6	1800.07.03.080	50

Erhältlich mit Dichteinsatz gemäss EN 45545. Bei Anfragen oder Bestellung bitte ein F vor die Artikelnummer setzen.

Available with sealing inserts conformity with EN 45545. When placing an inquiry, prefix the article number by the capital F.



Progress MS KB



Zweiteiliger Dichteinsatz
 nicht durchgehend isolierend

Two-piece sealing insert
 not overall length insulated

G	>Ø< min mm	>Ø< max mm	IC	H mm	L mm	Art.-Nr. Art. No.	
Pg 9	6.0	10.5	18/19	30	6	1800.09.03.105	50
Pg 11	5.5	12.0	21	31	6	1800.11.03.120	50
Pg 13	8.0	15.0	24	31	6	1800.13.03.150	50
Pg 16	8.0	15.0	24	31	6	1800.16.03.150	50
Pg 21	12.5	20.5	30	35	7	1800.21.03.205	25
Pg 29	19.0	27.5	38	40	8	1800.29.03.275	25
Pg 36	26.0	35.0	50	47	8	1800.36.03.350	10
Pg 42	33.0	42.0	55	49	10	1800.42.03.410	10
Pg 48	37.0	49.0	65	51	11	1800.48.03.490	5

Erhältlich mit Dichteinsatz gemäss EN 45545. Bei Anfragen oder Bestellung bitte ein F vor die Artikelnummer setzen.

Available with sealing inserts conformity with EN 45545. When placing an inquiry, prefix the article number by the capital F.

Kabelverschraubungen Progress® Messing mit Klemmbacken

Cable glands Progress® nickel-plated brass with clamps

Langes Anschlussgewinde Pg | Long entry thread Pg

Material: Messing vernickelt
 Klemmschrauben: Rostfreier Stahl A2
 Dichtung: TPE
 O-Ring : NBR
 Einsatztemperatur: -40°C / +100°C
 Schutzart: IP 68 (bis 10 bar)
 Weitere Schutzart: IP 69K

Material: Nickel-plated brass
 Screws: Stainless steel A2
 Seal: TPE
 O-ring : NBR
 Temperature range: -40°C / +100°C
 Protection class: IP 68 (up to 10 bar)
 Further protection: IP 69K

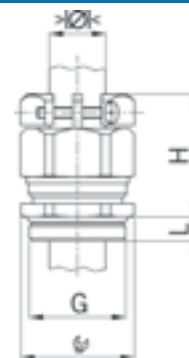

Progress MS KB



Einteiliger Dichteinsatz
 nicht durchgehend isolierend

One-piece sealing insert
 not overall length insulated

G	>Ø< min mm	>Ø< max mm		H mm	L mm	Art.-Nr. Art. No.	
Pg 7	5.0	6.5	15/16	26	10	1800.07.13.065	50
Pg 7	6.5	8.0	15/16	26	10	1800.07.13.080	50

Erhältlich mit Dichteinsatz gemäss EN 45545. Bei Anfragen oder Bestellung bitte ein F vor die Artikelnummer setzen.

Available with sealing inserts conformity with EN 45545. When placing an inquiry, prefix the article number by the capital F.



Progress MS KB



Zweiteiliger Dichteinsatz
 nicht durchgehend isolierend

Two-piece sealing insert
 not overall length insulated

G	>Ø< min mm	>Ø< max mm		H mm	L mm	Art.-Nr. Art. No.	
Pg 9	6.0	10.5	18/19	30	10	1800.09.13.105	50
Pg 11	5.5	12.0	21	31	10	1800.11.13.120	50
Pg 13	8.0	15.0	24	31	10	1800.13.13.150	50
Pg 16	8.0	15.0	24	31	10	1800.16.13.150	50
Pg 21	12.5	20.5	30	35	12	1800.21.13.205	25
Pg 29	19.0	27.5	38	40	12	1800.29.13.275	25
Pg 36	26.0	35.0	50	47	15	1800.36.13.350	10
Pg 42	33.0	42.0	55	49	15	1800.42.13.410	10
Pg 48	37.0	49.0	65	51	15	1800.48.13.490	5

Erhältlich mit Dichteinsatz gemäss EN 45545. Bei Anfragen oder Bestellung bitte ein F vor die Artikelnummer setzen.

Available with sealing inserts conformity with EN 45545. When placing an inquiry, prefix the article number by the capital F.



Kabelverschraubungen Progress® Messing mit Klemmbacken

Cable glands Progress® nickel-plated brass with clamps

Anschlussgewinde metrisch | Entry thread metric

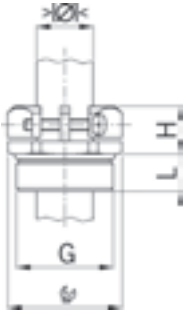

Material: Messing vernickelt
 Klemmschrauben: Rostfreier Stahl A2
 Zugentlastung: Ausführung B
 Einsatztemperatur: -50°C / +300°C
 Schutzart: IP 20

Material: Nickel-plated brass
 Screws: Stainless steel A2
 Strain relief: Version B
 Temperature range: -50°C / +300°C
 Protection class: IP 20



Progress MS KBST



Mechanische Zugentlastung B					Mechanical strain relief B			
G	> Ø < min mm	> Ø < max mm	IP	H mm	L mm	Art.-Nr. Art. No.		
M12x1.5	5.0	8.0	16	10	10	1812.02	50	
M16x1.5	6.0	10.5	19	11	10	1817.02	50	
M20x1.5	8.0	15.0	24	12	10	1820.02	50	
M25x1.5	12.5	20.5	30	13	11	1825.02	25	
M32x1.5	17.0	25.5	36	15	13	1832.02	25	
M40x1.5	24.0	33.0	46	17	13	1840.02	10	

Kabelverschraubungen Progress® Messing mit Klemmbacken

Cable glands Progress® nickel-plated brass with clamps



Anschlussgewinde Pg | Entry thread Pg

Material: Messing vernickelt
 Klemmschrauben: Rostfreier Stahl A2
 Einsatztemperatur: -50°C / +300°C
 Schutzart: IP 20

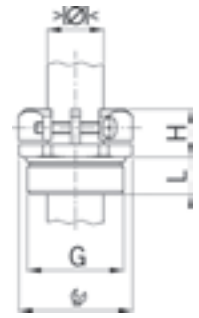
Material: Nickel-plated brass
 Screws: Stainless steel A2
 Temperature range: -50°C / +300°C
 Protection class: IP 20



Progress MS KBST

Mechanische Zugentlastung B					Mechanical strain relief B			
G	> Ø < min mm	> Ø < max mm		H mm	L mm	Art.-Nr. Art. No.		
Pg 7	4.0	8.0	17	10	5	1807.02	50	
Pg 9	6.0	10.0	20	11	6	1809.02	50	
Pg 11	6.0	12.0	22	11	6	1811.02	50	
Pg 13	7.0	15.0	24	11	7	1813.02	50	
Pg 16	9.0	17.0	27	12	7	1816.02	50	
Pg 21	12.0	22.0	35	14	8	1821.02	25	
Pg 29	18.0	30.0	42	15	8	1829.02	25	
Pg 36	24.0	36.0	55	18	10	1836.02	10	



1
2
3
4
5
6
7
8
9
10
11
12

Kabelverschraubungen Progress® Messing mit Trompete

Cable glands Progress® nickel-plated brass with trumpet

Kurzes Anschlussgewinde metrisch | Short entry thread metric

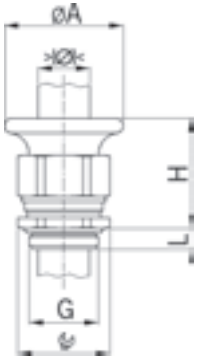

Material: Messing vernickelt
 Dichtung: TPE
 O-Ring : NBR
 Zugentlastung: Ausführung A
 Einsatztemperatur: -40°C / +100°C
 Schutzart: IP 68 (bis 10 bar)
 Weitere Schutzart: IP 69K

Material: Nickel-plated brass
 Seal: TPE
 O-ring : NBR
 Strain relief: Version A
 Temperature range: -40°C / +100°C
 Protection class: IP 68 (up to 10 bar)
 Further protection: IP 69K



Progress MS T

Zweiteiliger Dichteinsatz
 nicht durchgehend isolierend

Two-piece sealing insert
 not overall length insulated

G	> Ø < min mm	> Ø < max mm	IP	ØA mm	H mm	L mm	Art.-Nr. Art. No.	
M16x1.5	6.0	10.5	18	28	31	5	1800.10.17	50
M20x1.5	8.0	15.0	24	34	32	6	1800.10.20	50
M25x1.5	12.5	20.5	30	44	38	7	1800.10.25	25
M32x1.5	17.0	25.5	36	50	44	8	1800.10.32	25
M40x1.5	24.0	33.0	46	57	46	8	1800.10.40	10

Erhältlich mit Dichteinsatz gemäss EN 45545. Bei Anfragen oder Bestellung bitte ein F vor die Artikelnummer setzen.

Available with sealing inserts conformity with EN 45545. When placing an inquiry, prefix the article number by the capital F.



Langes Anschlussgewinde metrisch | Long entry thread metric

Progress MS T

Zweiteiliger Dichteinsatz
 nicht durchgehend isolierend

Two-piece sealing insert
 not overall length insulated

G	> Ø < min mm	> Ø < max mm	IP	ØA mm	H mm	L mm	Art.-Nr. Art. No.	
M16x1.5	6.0	10.5	18	28	31	10	1800.11.17	50
M20x1.5	8.0	15.0	24	34	32	10	1800.11.20	50
M25x1.5	12.5	20.5	30	44	38	11	1800.11.25	25
M32x1.5	17.0	25.5	36	50	44	13	1800.11.32	25
M40x1.5	24.0	33.0	46	57	46	13	1800.11.40	10

Erhältlich mit Dichteinsatz gemäss EN 45545. Bei Anfragen oder Bestellung bitte ein F vor die Artikelnummer setzen.

Available with sealing inserts conformity with EN 45545. When placing an inquiry, prefix the article number by the capital F.



Kabelverschraubungen Progress® Messing mit Trompete

Cable glands Progress® nickel-plated brass with trumpet

Kurzes Anschlussgewinde Pg | Short entry thread Pg

Material: Messing vernickelt
 Dichtung: TPE
 O-Ring : NBR
 Einsatztemperatur: -40°C / +100°C
 Schutzart: IP 68 (bis 10 bar)
 Weitere Schutzart: IP 69K

Material: Nickel-plated brass
 Seal: TPE
 O-ring : NBR
 Temperature range: -40°C / +100°C
 Protection class: IP 68 (up to 10 bar)
 Further protection: IP 69K

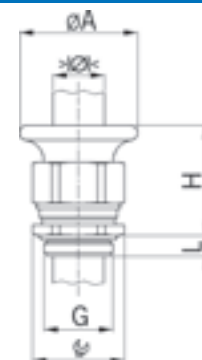

Progress MS T

Zweiteiliger Dichteinsatz
 nicht durchgehend isolierend

Two-piece sealing insert
 not overall length insulated

G	>Ø< min mm	>Ø< max mm		ØA mm	H mm	L mm	Art.-Nr. Art. No.	
Pg 9	6.0	10.5	18	28	31	6	1800.10.09	50
Pg 11	5.5	12.0	21	30	31	6	1800.10.11	50
Pg 13	8.0	15.0	24	34	32	6	1800.10.13	50
Pg 16	8.0	15.0	24	34	32	6	1800.10.16	50
Pg 21	12.5	20.5	30	44	38	7.5	1800.10.21	25
Pg 29	19.0	27.5	38	50	44	8	1800.10.29	10

Erhältlich mit Dichteinsatz gemäss EN 45545. Bei Anfragen oder Bestellung bitte ein F vor die Artikelnummer setzen.

Available with sealing inserts conformity with EN 45545. When placing an inquiry, prefix the article number by the capital F.



Langes Anschlussgewinde Pg | Long entry thread Pg

Progress MS T

Zweiteiliger Dichteinsatz
 nicht durchgehend isolierend

Two-piece sealing insert
 not overall length insulated

G	>Ø< min mm	>Ø< max mm		ØA mm	H mm	L mm	Art.-Nr. Art. No.	
Pg 9	6.0	10.5	18	28	31	10	1800.11.09	50
Pg 11	5.5	12.0	21	30	31	10	1800.11.11	50
Pg 13	8.0	15.0	24	34	32	10	1800.11.13	50
Pg 16	8.0	15.0	24	34	32	10	1800.11.16	50
Pg 21	12.5	20.5	30	44	38	12	1800.11.21	25
Pg 29	19.0	27.5	38	50	44	12	1800.11.29	10

Erhältlich mit Dichteinsatz gemäss EN 45545. Bei Anfragen oder Bestellung bitte ein F vor die Artikelnummer setzen.

Available with sealing inserts conformity with EN 45545. When placing an inquiry, prefix the article number by the capital F.



Kabelverschraubungen Progress® Messing mit Trompete / Klemmbacken

Cable glands Progress® nickel-plated brass with trumpet / clamps

Kurzes Anschlussgewinde metrisch | Short entry thread metric

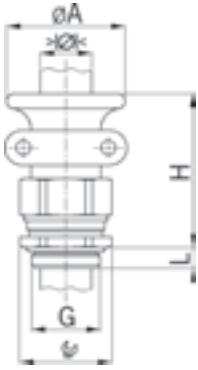

Material: Messing vernickelt
 Klemmschrauben: Rostfreier Stahl A2
 Dichtung: TPE
 O-Ring : NBR
 Zugentlastung: Ausführung B
 Einsatztemperatur: -40°C / +100°C
 Schutzart: IP 68 (bis 10 bar)
 Weitere Schutzart: IP 69K

Material: Nickel-plated brass
 Screws: Stainless steel A2
 Seal: TPE
 O-ring : NBR
 Strain relief: Version B
 Temperature range: -40°C / +100°C
 Protection class: IP 68 (up to 10 bar)
 Further protection: IP 69K



Progress MS T+KB

Zweiteiliger Dichteinsatz
 nicht durchgehend isolierend

Two-piece sealing insert
 not overall length insulated



G	>Ø< min mm	>Ø< max mm	IC	ØA mm	H mm	L mm	Art.-Nr. Art. No.	
M16x1.5	6.0	10.5	18	28	43	5	1801.10.17	50
M20x1.5	8.0	15.0	24	34	46	6	1801.10.20	50
M25x1.5	12.5	20.5	30	44	52	7	1801.10.25	25
M32x1.5	17.0	25.5	36	50	59	8	1801.10.32	10
M40x1.5	24.0	33.0	46	57	59	8	1801.10.40	5

Erhältlich mit Dichteinsatz gemäss EN 45545. Bei Anfragen oder Bestellung bitte ein F vor die Artikelnummer setzen.

Available with sealing inserts conformity with EN 45545. When placing an inquiry, prefix the article number by the capital F.

Langes Anschlussgewinde metrisch | Long entry thread metric

Progress MS T+KB

Zweiteiliger Dichteinsatz
 nicht durchgehend isolierend

Two-piece sealing insert
 not overall length insulated



G	>Ø< min mm	>Ø< max mm	IC	ØA mm	H mm	L mm	Art.-Nr. Art. No.	
M16x1.5	6.0	10.5	18	28	43	10	1801.11.17	50
M20x1.5	8.0	15.0	24	34	46	10	1801.11.20	50
M25x1.5	12.5	20.5	30	44	52	11	1801.11.25	25
M32x1.5	17.0	25.5	36	50	59	13	1801.11.32	10
M40x1.5	24.0	33.0	46	57	59	13	1801.11.40	5

Erhältlich mit Dichteinsatz gemäss EN 45545. Bei Anfragen oder Bestellung bitte ein F vor die Artikelnummer setzen.

Available with sealing inserts conformity with EN 45545. When placing an inquiry, prefix the article number by the capital F.

Kabelverschraubungen Progress® Messing mit Trompete / Klemmbacken

Cable glands Progress® nickel-plated brass with trumpet / clamps

Kurzes Anschlussgewinde Pg | Short entry thread Pg

Material: Messing vernickelt
 Klemmschrauben: Rostfreier Stahl A2
 Dichtung: TPE
 O-Ring : NBR
 Einsatztemperatur: -40°C / +100°C
 Schutzart: IP 68 (bis 10 bar)
 Weitere Schutzart: IP 69K

Material: Nickel-plated brass
 Screws: Stainless steel A2
 Seal: TPE
 O-ring : NBR
 Temperature range: -40°C / +100°C
 Protection class: IP 68 (up to 10 bar)
 Further protection: IP 69K

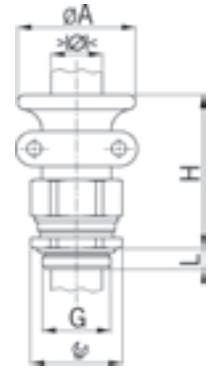

Progress MS T+KB

Zweiteiliger Dichteinsatz nicht durchgehend isolierend				Two-piece sealing insert not overall length insulated			
G	> Ø < min mm	> Ø < max mm		ØA mm	H mm	L mm	Art.-Nr. Art. No.
Pg 9	6.0	10.5	18	28	43	6	1801.10.09 50
Pg 11	5.5	12.0	21	30	43	6	1801.10.11 50
Pg 13	8.0	15.0	24	34	46	6	1801.10.13 50
Pg 16	8.0	15.0	24	34	46	6	1801.10.16 50
Pg 21	12.5	20.5	30	44	52	7.5	1801.10.21 25
Pg 29	19.0	27.5	38	50	59	8	1801.10.29 10

Erhältlich mit Dichteinsatz gemäss EN 45545. Bei Anfragen oder Bestellung bitte ein F vor die Artikelnummer setzen. Available with sealing inserts conformity with EN 45545. When placing an inquiry, prefix the article number by the capital F.



Langes Anschlussgewinde Pg | Long entry thread Pg

Progress MS T+KB

Zweiteiliger Dichteinsatz nicht durchgehend isolierend				Two-piece sealing insert not overall length insulated			
G	> Ø < min mm	> Ø < max mm		ØA mm	H mm	L mm	Art.-Nr. Art. No.
Pg 9	6.0	10.5	18	28	43	10	1801.11.09 50
Pg 11	5.5	12.0	21	30	43	10	1801.11.11 50
Pg 13	8.0	15.0	24	34	46	10	1801.11.13 50
Pg 16	8.0	15.0	24	34	46	10	1801.11.16 50
Pg 21	12.5	20.5	30	44	52	12	1801.11.21 25
Pg 29	19.0	27.5	38	50	59	12	1801.11.29 10

Erhältlich mit Dichteinsatz gemäss EN 45545. Bei Anfragen oder Bestellung bitte ein F vor die Artikelnummer setzen. Available with sealing inserts conformity with EN 45545. When placing an inquiry, prefix the article number by the capital F.



Kabelverschraubungen Progress® aus rostfreiem Stahl

Cable glands Progress® stainless steel

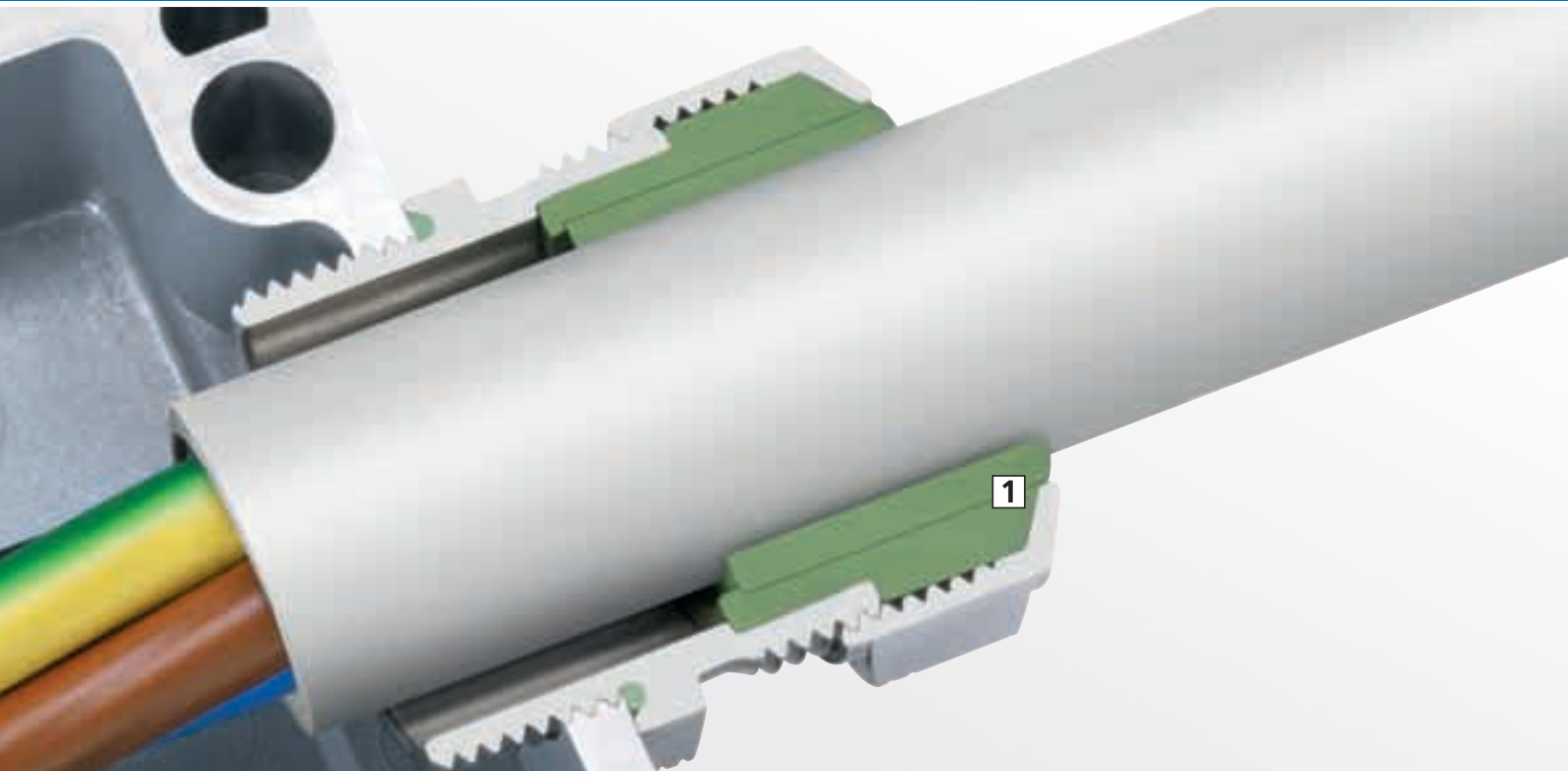

AGRO Kabelverschraubungen Progress® aus rostfreiem Stahl

weisen eine hohe Korrosionsbeständigkeit und Langlebigkeit auf. Sie sind prädestiniert für den erschwerten Einsatz in der Lebensmittel sowie chemischen Industrie oder auch an Orten mit besonderen Umweltbedingungen wie z.B. in Tunneln oder auf hoher See. Rostfreie Stähle werden durch die zugeordnete Werkstoffnummer eindeutig spezifiziert. AGRO verwendet für die Kabelverschraubungen den rostfreien Stahl A2 mit der Werkstoffnummer 1.4305 (AISI 303) und für den rostfreien und säurebeständigen Stahl A4 den Werkstoff 1.4435 (AISI 316L).

1 Garantierte Dichtigkeit

Auf den Dichteinsatz abgestimmte Innenkonturen sorgen für eine zielgerichtete Verformung des Dichteinsatzes und garantieren somit dessen perfekte Abdichtung. Die Schutzart IP 68 bis 10 bar sowie IP 69K ermöglichen eine breite Anwendung.

AGRO cable glands Progress® made of stainless steel

are highly corrosion-proof and persistent. They are favorable for any application in food or chemical industries or under difficult environmental conditions such as tunnels or in offshore zones. Stainless steels are specified unequivocally by the allocated material number. For the cable glands, ARGO uses the stainless steel A2 with the material number 1.4305 (AISI 303) and for the stainless and acid-resistant steel A4 the material 1.4435 (AISI 316L).

1 Guaranteed seal

Inner contours matched to the sealing insert ensure a targeted deformation of the insert and thus guarantee its tightness in compliance with protection class IP 68 up to 10 bar and IP 69K for a wide range of applications.

Kennzeichnung Stahltyp

Identification marks of steel type



1 Rille kennzeichnet **Stahl A2**.
Dichteinsatz in TPE (schwarz)

1 groove identifies steel A2.
Sealing insert TPE (black).

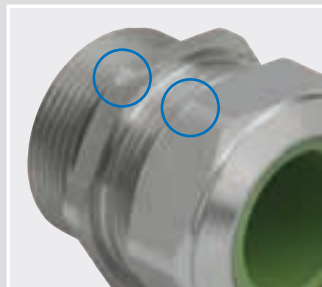

1 Rille kennzeichnet **Stahl A2**.
Dichteinsatz in FPM für hohe Temperaturen (grün)

1 groove identifies steel A2.
Sealing insert FPM for high temperature applications (green).

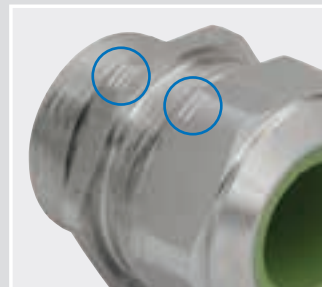

2 Rillen kennzeichnen **Stahl A4**.
Dichteinsatz in FPM für hohe Temperaturen und Säurebeständigkeit (grün)

2 grooves identify steel A4.
Sealing insert FPM for high temperature applications and resistant to acids (green).



Kabelverschraubungen Progress® rostfreier Stahl A2 Cable glands Progress® stainless steel A2		60 - 61
Kabelverschraubungen Progress® rostfreier Stahl A2 für hohe Temperaturen Cable glands Progress® stainless steel A2 for high temperature applications		62 - 63
Kabelverschraubungen Progress® rostfreier und säurebeständiger Stahl A4 für hohe Temperaturen Cable glands Progress® stainless and acid-resistant steel A4 for high temperature applications		64 - 65

Kabelverschraubungen Progress®
 Cable glands Progress®
 rostfreier Stahl A2
 stainless steel A2
 rostfreier Stahl A2
 für hohe Temperaturen
 stainless steel A2
 for high temperature applications
 rostfreier und säurebeständiger
 Stahl A4 für hohe Temperaturen
 stainless and acid-resistant steel A4
 for high temperature applications

Ausführung / Version				
Kompressionstechnik Compression technology		•	•	•
Gewinde / Thread				
Anschlussgewinde metrisch Entry thread metric		•	•	•
Anschlussgewinde Pg Entry thread Pg		•	•	•
Langes Anschlussgewinde Long entry thread		•	•	•
Kurzes Anschlussgewinde (Standard) Short entry thread (standard)		A	A	A
Dichteinsatz / Sealing insert				
für Rundkabel for round cables		•	•	•
für mehrere Kabel (Multi-Dichteinsatz) for multi sealing insert		A	A	A
Dichteinsatz ohne Bohrung Sealing insert without drilled hole		A	A	A
Einteiliger Dichteinsatz One-piece sealing insert		•	•	•
Zweiteiliger Dichteinsatz Two-piece sealing insert		•	•	•
Dichteinsatz für EN 45545 Sealing insert for EN 45545		•	-	-
Technische Besonderheiten / Technical features				
Hohe Säurebeständigkeit High acid-resistant		-	-	•
Material / Material				
rostfreier Stahl A2 Stainless steel A2		•	•	-
rostfreier Stahl A4 Stainless steel A4		-	-	•

A = Auf Anfrage / upon request

1
2
3
4
5
6
7
8
9
10
11
12

Kabelverschraubungen Progress® rostfreier Stahl A2

Cable glands Progress® stainless steel A2

Langes Anschlussgewinde metrisch | Long entry thread metric

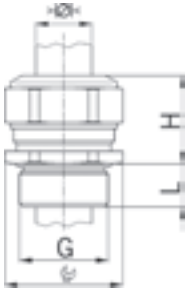

Material: Rostfreier CrNi-Stahl A2 (DIN EN 1.4305 / AISI 303)
 Kennzeichnung: 1 Rille
 Dichtung: TPE
 O-Ring : NBR
 Zugentlastung: Ausführung A
 Einsatztemperatur: -40°C / +100°C
 Schutzart: IP 68 (bis 10 bar)
 Weitere Schutzart: IP 69K

Material: CrNi stainless steel A2 (DIN EN 1.4305 / AISI 303)
 Identification: 1 groove
 Seal: TPE
 O-ring : NBR
 Strain relief: Version A
 Temperature range: -40°C / +100°C
 Protection class: IP 68 (up to 10 bar)
 Further protection: IP 69K



Progress S2

Einteiliger Dichteinsatz
nicht durchgehend isolierend

One-piece sealing insert
not overall length insulated

G	> Ø < min mm	> Ø < max mm	1	H mm	L mm	i info	Art.-Nr. Art. No.	
M8x1.25	2.5	3.5	11	14	10	1	1100.08.94.035	50
M8x1.25	3.5	5.0	11	14	10	1	1100.08.94.050	50
M10x1.5	3.0	4.0	13	15	10	1	1100.10.94.040	50
M10x1.5	4.0	6.0	13	15	10	1	1100.10.94.060	50
M12x1.5	3.5	5.0	17	17	10	-	1100.12.94.050	50
M12x1.5	5.0	6.5	17	17	10	-	1100.12.94.065	50
M12x1.5	6.5	8.0	17	17	10	-	1100.12.94.080	50
M16x1.5	8.0	10.5	19	20	10	-	1100.17.94.105	50
M20x1.5	11.0	15.0	24	21	10	-	1100.20.94.150	50
M25x1.5	16.0	20.5	30	25	11	-	1100.25.94.205	25
M32x1.5	21.0	25.5	36	28	13	-	1100.32.94.255	25
M40x1.5	28.5	33.0	46	31	13	-	1100.40.94.330	10
M50x1.5	37.0	42.0	55	34	14	-	1100.50.94.420	10
M63x1.5	46.0	52.0	70	37	14	-	1100.63.94.520	5

1 = Metrisches Regelgewinde

1 = Metric coarse-pitch thread

Erhältlich mit Dichteinsatz gemäss EN 45545. Bei Anfragen oder Bestellung bitte ein F vor die Artikelnummer setzen.

Available with sealing inserts conformity with EN 45545. When placing an inquiry, prefix the article number by the capital F.



Progress S2

Zweiteiliger Dichteinsatz
nicht durchgehend isolierend

Two-piece sealing insert
not overall length insulated

G	> Ø < min mm	> Ø < max mm	1	H mm	L mm	Art.-Nr. Art. No.	
M16x1.5	6.0	10.5	19	20	10	1100.17.94	50
M20x1.5	8.0	15.0	24	21	10	1100.20.94	50
M25x1.5	12.5	20.5	30	25	11	1100.25.94	25
M32x1.5	17.0	25.5	36	28	13	1100.32.94	25
M40x1.5	24.0	33.0	46	31	13	1100.40.94	10
M50x1.5	33.0	42.0	55	34	14	1100.50.94	10
M63x1.5	40.0	52.0	70	37	14	1100.63.94	5

Erhältlich mit Dichteinsatz gemäss EN 45545. Bei Anfragen oder Bestellung bitte ein F vor die Artikelnummer setzen.

Available with sealing inserts conformity with EN 45545. When placing an inquiry, prefix the article number by the capital F.

Kabelverschraubungen Progress® rostfreier Stahl A2

Cable glands Progress® stainless steel A2

Langes Anschlussgewinde Pg | Long entry thread Pg

Material: Rostfreier CrNi-Stahl A2 (DIN EN 1.4305 / AISI 303)
 Kennzeichnung: 1 Rille
 Dichtung: TPE
 O-Ring : NBR
 Einsatztemperatur: -40°C / +100°C
 Schutzart: IP 68 (bis 10 bar)
 Weitere Schutzart: IP 69K

Material: CrNi stainless steel A2 (DIN EN 1.4305 / AISI 303)
 Identification: 1 groove
 Seal: TPE
 O-ring : NBR
 Temperature range: -40°C / +100°C
 Protection class: IP 68 (up to 10 bar)
 Further protection: IP 69K

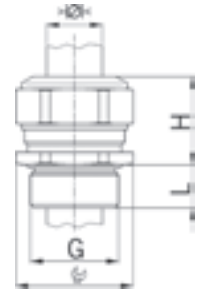

Progress S2



Einteiliger Dichteinsatz
 nicht durchgehend isolierend

One-piece sealing insert
 not overall length insulated

G	> Ø < min mm	> Ø < max mm		H mm	L mm	Art.-Nr. Art. No.	
Pg 7	3.5	5.0	17	17	10	1100.07.94.050	50
Pg 7	5.0	6.5	17	17	10	1100.07.94.065	50
Pg 7	6.5	8.0	17	17	10	1100.07.94.080	50
Pg 9	8.0	10.5	19	20	10	1100.09.94.105	50
Pg 11	8.5	12.0	22	21	10	1100.11.94.120	50
Pg 13	11.0	15.0	24	21	10	1100.13.94.150	50
Pg 16	11.0	15.0	24	21	10	1100.16.94.150	50
Pg 21	16.0	20.5	30	25	12	1100.21.94.205	25
Pg 29	23.0	27.5	41	28	12	1100.29.94.275	25
Pg 36	30.5	35.0	50	32	15	1100.36.94.350	10
Pg 42	37.0	42.0	55	34	15	1100.42.94.420	10
Pg 48	43.0	49.0	65	37	15	1100.48.94.490	10

Erhältlich mit Dichteinsatz gemäss EN 45545. Bei Anfragen oder Bestellung bitte ein F vor die Artikelnummer setzen.

Available with sealing inserts conformity with EN 45545. When placing an inquiry, prefix the article number by the capital F.



Progress S2



Zweiteiliger Dichteinsatz
 nicht durchgehend isolierend

Two-piece sealing insert
 not overall length insulated

G	> Ø < min mm	> Ø < max mm		H mm	L mm	Art.-Nr. Art. No.	
Pg 9	6.0	10.5	19	20	10	1100.09.94	50
Pg 11	5.5	12.0	21	21	10	1100.11.94	50
Pg 13	8.0	15.0	24	21	10	1100.13.94	50
Pg 16	8.0	15.0	24	21	10	1100.16.94	50
Pg 21	12.5	20.5	30	25	12	1100.21.94	25
Pg 29	19.0	27.5	41	28	12	1100.29.94	25
Pg 36	26.0	35.0	50	32	15	1100.36.94	10
Pg 42	33.0	42.0	55	34	15	1100.42.94	10
Pg 48	37.0	49.0	65	37	15	1100.48.94	10

Erhältlich mit Dichteinsatz gemäss EN 45545. Bei Anfragen oder Bestellung bitte ein F vor die Artikelnummer setzen.

Available with sealing inserts conformity with EN 45545. When placing an inquiry, prefix the article number by the capital F.



Kabelverschraubungen Progress® rostfreier Stahl A2 für hohe Temperaturen

Cable glands Progress® stainless steel A2 for high temperature applications

Langes Anschlussgewinde metrisch | Long entry thread metric

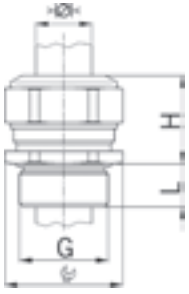

Material: Rostfreier CrNi-Stahl A2 (DIN EN 1.4305 / AISI 303)
 Kennzeichnung: 1 Rille
 Dichtung: FPM
 O-Ring : FPM
 Zugentlastung: Ausführung A
 Einsatztemperatur: -40°C / +200°C
 Schutzart: IP 68 (bis 10 bar)
 Weitere Schutzart: IP 69K

Material: CrNi stainless steel A2 (DIN EN 1.4305 / AISI 303)
 Identification: 1 groove
 Seal: FPM
 O-ring : FPM
 Strain relief: Version A
 Temperature range: -40°C / +200°C
 Protection class: IP 68 (up to 10 bar)
 Further protection: IP 69K



Progress S2 HT



Einteiliger Dichteinsatz
 nicht durchgehend isolierend

One-piece sealing insert
 not overall length insulated

G	>Ø< min mm	>Ø< max mm	PG	H mm	L mm	i info	Art.-Nr. Art. No.	
M8x1.25	2.5	3.5	11	14	10	1	1100.08.96.035	50
M8x1.25	3.5	5.0	11	14	10	1	1100.08.96.050	50
M10x1.5	3.0	4.0	13	15	10	1	1100.10.96.040	50
M10x1.5	4.0	6.0	13	15	10	1	1100.10.96.060	50
M12x1.5	3.5	5.0	17	17	10	-	1100.12.96.050	50
M12x1.5	5.0	6.5	17	17	10	-	1100.12.96.065	50
M12x1.5	6.5	8.0	17	17	10	-	1100.12.96.080	50
M16x1.5	8.0	10.5	19	20	10	-	1100.17.96.105	50
M20x1.5	11.0	15.0	24	21	10	-	1100.20.96.150	50
M25x1.5	16.0	20.5	30	25	11	-	1100.25.96.205	25
M32x1.5	21.0	25.5	36	28	13	-	1100.32.96.255	25
M40x1.5	28.5	33.0	46	31	13	-	1100.40.96.330	10
M50x1.5	37.0	42.0	55	34	14	-	1100.50.96.420	10
M63x1.5	46.0	52.0	70	37	14	-	1100.63.96.520	5

1 = Metrisches Regelgewinde

1 = Metric coarse-pitch thread

Progress S2 HT



Zweiteiliger Dichteinsatz
 nicht durchgehend isolierend

Two-piece sealing insert
 not overall length insulated

G	>Ø< min mm	>Ø< max mm	PG	H mm	L mm	Art.-Nr. Art. No.	
M16x1.5	6.0	10.5	19	20	10	1100.17.96	50
M20x1.5	8.0	15.0	24	21	10	1100.20.96	50
M25x1.5	12.5	20.5	30	25	11	1100.25.96	25
M32x1.5	17.0	25.5	36	28	13	1100.32.96	25
M40x1.5	24.0	33.0	46	31	13	1100.40.96	10
M50x1.5	33.0	42.0	55	34	14	1100.50.96	10
M63x1.5	40.0	52.0	70	37	14	1100.63.96	5

Kabelverschraubungen Progress® rostfreier Stahl A2 für hohe Temperaturen

Cable glands Progress® stainless steel A2 for high temperature applications

Langes Anschlussgewinde Pg | Long entry thread Pg

Material: Rostfreier CrNi-Stahl A2 (DIN EN 1.4305 / AISI 303)
 Kennzeichnung: 1 Rille
 Dichtung: FPM
 O-Ring : FPM
 Einsatztemperatur: -40°C / +200°C
 Schutzart: IP 68 (bis 10 bar)
 Weitere Schutzart: IP 69K

Material: CrNi stainless steel A2 (DIN EN 1.4305 / AISI 303)
 Identification: 1 groove
 Seal: FPM
 O-ring : FPM
 Temperature range: -40°C / +200°C
 Protection class: IP 68 (up to 10 bar)
 Further protection: IP 69K

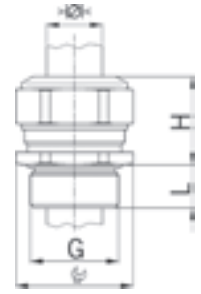

Progress S2 HT



Einteiliger Dichteinsatz
 nicht durchgehend isolierend

One-piece sealing insert
 not overall length insulated

G	> Ø < min mm	> Ø < max mm		H mm	L mm	Art.-Nr. Art. No.	
Pg 7	3.5	5.0	17	17	10	1100.07.96.050	50
Pg 7	5.0	6.5	17	17	10	1100.07.96.065	50
Pg 7	6.5	8.0	17	17	10	1100.07.96.080	50
Pg 9	8.0	10.5	19	20	10	1100.09.96.105	50
Pg 11	8.5	12.0	22	21	10	1100.11.96.120	50
Pg 13	11.0	15.0	24	21	10	1100.13.96.150	50
Pg 16	11.0	15.0	24	21	10	1100.16.96.150	50
Pg 21	16.0	20.5	30	25	12	1100.21.96.205	25
Pg 29	23.0	27.5	41	28	12	1100.29.96.275	25
Pg 36	30.5	35.0	50	32	15	1100.36.96.350	10
Pg 42	37.0	42.0	55	34	15	1100.42.96.420	10
Pg 48	43.0	49.0	65	37	15	1100.48.96.490	10



Progress S2 HT



Zweiteiliger Dichteinsatz
 nicht durchgehend isolierend

Two-piece sealing insert
 not overall length insulated

G	> Ø < min mm	> Ø < max mm		H mm	L mm	Art.-Nr. Art. No.	
Pg 9	6.0	10.5	19	20	10	1100.09.96	50
Pg 11	5.5	12.0	22	21	10	1100.11.96	50
Pg 13	8.0	15.0	24	21	10	1100.13.96	50
Pg 16	8.0	15.0	24	21	10	1100.16.96	50
Pg 21	12.5	20.5	30	25	12	1100.21.96	25
Pg 29	19.0	27.5	41	28	12	1100.29.96	25
Pg 36	26.0	35.0	50	32	15	1100.36.96	10
Pg 42	33.0	42.0	55	34	15	1100.42.96	10
Pg 48	37.0	49.0	65	37	15	1100.48.96	10



Langes Anschlussgewinde metrisch | Long entry thread metric

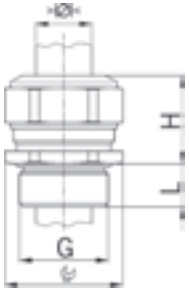

Material: Rostfreier und säurebeständiger CrNiMo-Stahl A4 (DIN EN 1.4435 / AISI 316L)
 Kennzeichnung: 2 Rillen
 Dichtung: FPM
 O-Ring : FPM
 Zugentlastung: Ausführung A
 Einsatztemperatur: -40°C / +200°C
 Schutzart: IP 68 (bis 10 bar)
 Weitere Schutzart: IP 69K

Material: Stainless and acid resistant steel A4 CrNiMo (DIN EN 1.4435 / AISI 316L)
 Identification: 2 grooves
 Seal: FPM
 O-ring : FPM
 Strain relief: Version A
 Temperature range: -40°C / +200°C
 Protection class: IP 68 (up to 10 bar)
 Further protection: IP 69K



Progress S4 HT



Einteiliger Dichteinsatz
 nicht durchgehend isolierend

One-piece sealing insert
 not overall length insulated

G	> Ø < min mm	> Ø < max mm	PG	H mm	L mm	i info	Art.-Nr. Art. No.	
M8x1.25	2.5	3.5	11	14	10	1	1100.08.98.035	50
M8x1.25	3.5	5.0	11	14	10	1	1100.08.98.050	50
M10x1.5	3.0	4.0	13	15	10	1	1100.10.98.040	50
M10x1.5	4.0	6.0	13	15	10	1	1100.10.98.060	50
M12x1.5	3.5	5.0	17	17	10	-	1100.12.98.050	50
M12x1.5	5.0	6.5	17	17	10	-	1100.12.98.065	50
M12x1.5	6.5	8.0	17	17	10	-	1100.12.98.080	50
M16x1.5	8.0	10.5	19	20	10	-	1100.17.98.105	50
M20x1.5	11.0	15.0	24	21	10	-	1100.20.98.150	50
M25x1.5	16.0	20.5	30	25	11	-	1100.25.98.205	25
M32x1.5	21.0	25.5	36	28	13	-	1100.32.98.255	25
M40x1.5	28.5	33.0	46	31	13	-	1100.40.98.330	10
M50x1.5	37.0	42.0	55	34	14	-	1100.50.98.420	10
M63x1.5	46.0	52.0	70	37	14	-	1100.63.98.520	5

1 = Metrisches Regelgewinde

1 = Metric coarse-pitch thread

Progress S4 HT



Zweiteiliger Dichteinsatz
 nicht durchgehend isolierend

Two-piece sealing insert
 not overall length insulated

G	> Ø < min mm	> Ø < max mm	PG	H mm	L mm	Art.-Nr. Art. No.	
M16x1.5	6.0	10.5	19	20	10	1100.17.98	50
M20x1.5	8.0	15.0	24	21	10	1100.20.98	50
M25x1.5	12.5	20.5	30	25	11	1100.25.98	25
M32x1.5	17.0	25.5	36	28	13	1100.32.98	25
M40x1.5	24.0	33.0	46	31	13	1100.40.98	10
M50x1.5	33.0	42.0	55	34	14	1100.50.98	10
M63x1.5	40.0	52.0	70	37	14	1100.63.98	5



Langes Anschlussgewinde Pg | Long entry thread Pg

Material: Rostfreier und säurebeständiger CrNiMo-Stahl A4 (DIN EN 1.4435 / AISI 316L)
 Kennzeichnung: 2 Rillen
 Dichtung: FPM
 O-Ring : FPM
 Einsatztemperatur: -40°C / +200°C
 Schutzart: IP 68 (bis 10 bar)
 Weitere Schutzart: IP 69K

Material: Stainless and acid resistant steel A4 CrNi-Mo (DIN EN 1.4435 / AISI 316L)
 Identification: 2 grooves
 Seal: FPM
 O-ring : FPM
 Temperature range: -40°C / +200°C
 Protection class: IP 68 (up to 10 bar)
 Further protection: IP 69K

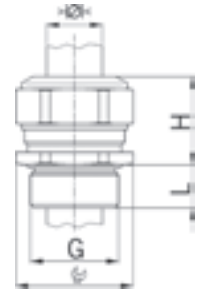

Progress S4 HT



Einteiliger Dichteinsatz
 nicht durchgehend isolierend

One-piece sealing insert
 not overall length insulated

G	> Ø < min mm	> Ø < max mm		H mm	L mm	Art.-Nr. Art. No.	
Pg 7	3.5	5.0	17	17	10	1100.07.98.050	50
Pg 7	5.0	6.5	17	17	10	1100.07.98.065	50
Pg 7	6.5	8.0	17	17	10	1100.07.98.080	50
Pg 9	8.0	10.5	19	20	10	1100.09.98.105	50
Pg 11	8.5	12.0	22	21	10	1100.11.98.120	50
Pg 13	11.0	15.0	24	21	10	1100.13.98.150	50
Pg 16	11.0	15.0	24	21	10	1100.16.98.150	50
Pg 21	16.0	20.5	30	25	12	1100.21.98.205	25
Pg 29	23.0	27.5	41	28	12	1100.29.98.275	25
Pg 36	30.5	35.0	50	32	15	1100.36.98.350	10
Pg 42	37.0	42.0	55	34	15	1100.42.98.420	10
Pg 48	43.0	49.0	65	37	15	1100.48.98.490	10



Progress S4 HT



Zweiteiliger Dichteinsatz
 nicht durchgehend isolierend

Two-piece sealing insert
 not overall length insulated

G	> Ø < min mm	> Ø < max mm		H mm	L mm	Art.-Nr. Art. No.	
Pg 9	6.0	10.5	19	20	10	1100.09.98	50
Pg 11	5.5	12.0	22	21	10	1100.11.98	50
Pg 13	8.0	15.0	24	21	10	1100.13.98	50
Pg 16	8.0	15.0	24	21	10	1100.16.98	50
Pg 21	12.5	20.5	30	25	12	1100.21.98	25
Pg 29	19.0	27.5	41	28	12	1100.29.98	25
Pg 36	26.0	35.0	50	32	15	1100.36.98	10
Pg 42	33.0	42.0	55	34	15	1100.42.98	10
Pg 48	37.0	49.0	65	37	15	1100.48.98	10



Spezielle Kabelverschraubungen und -einführungen aus Messing Special cable glands and cable entries nickel-plated brass



Die **Progress® ultraFLAT** ist eine Kabelverschraubung für vier Anwendungsgebiete - den Reinraum, die Lebensmittelindustrie, den Antivandalismus und das Design. Die ultraflache Konstruktion der Kabelverschraubung **Progress® ultraFLAT** verhindert eine Manipulation von aussen. Sie bietet keine Angriffsfläche für eine Beeinträchtigung von Hand oder auch mit Werkzeugen. Ausserdem überzeugt die Kabelverschraubung durch ihre schlichte und überaus ansprechende Formgebung für den Einsatz in Design-Applikationen.

Die Kabelverschraubung **Progress® ultraFLAT** bietet wenig Oberfläche, an der sich Verschmutzungen ablagern können - die gute Reinigbarkeit für den Einsatz in Reinräumen oder der Lebensmittelindustrie wird durch die Zertifizierung bei der European Hygienic Engineering & Design Group (EHEDG) bestätigt. Ausführungen in Edelstahl und Dichteinsätze für Hochtemperaturen oder mit FDA Konformität sprechen für diese Wahl.

Sind bei der Kabelinstallation enge Raumverhältnisse gegeben, kann der Anwender auf die Vorteile von **Winkeln und Flanschswinkeln** bauen.

Hier werden Leitungen um die Ecke geführt und je nach der verwendeten Kabelverschraubung zu 100% vor der Knickstelle zugentlastet. Zur Auswahl stehen neben 90°-Winkeln auch 45°-Winkel für eine leichte Biegung des Kabels.

EHEDG Zertifizierung

Die **European Hygienic Engineering & Design Group** (EHEDG) ist eine Expertengemeinschaft von Maschinen- und Komponenten-Herstellern, Fachleuten aus der Nahrungsmittelindustrie sowie von Forschungsinstituten und Gesundheitsbehörden. Die Organisation wurde 1989 in der Absicht gegründet, das Bewusstsein für Hygiene bei der Verarbeitung und Verpackung von Nahrungsmitteln zu stärken.

Die Hauptaufgabe der EHEDG ist es, zur hygienegerechten Konstruktion und Gestaltung in allen Bereichen der Nahrungsmittelproduktion beizutragen und damit eine sichere Herstellung von Lebensmitteln zu gewährleisten.



EHEDG Certification

The **European Hygienic Engineering & Design Group** (EHEDG) is a consortium of equipment manufacturers, food industries, research institutes as well as public health authorities and was founded in 1989 with the aim to promote hygiene during the processing and packing of food products.

The principal goal of EHEDG is the promotion of safe food by improving hygienic engineering and design in all aspects of food manufacture.



<p>Kabelverschraubungen Progress® ultraFLAT Cable glands Progress® ultraFLAT</p>		<p>68 - 69</p>	<p>1</p>
<p>Kabelverschraubungen Progress® Messing Winkel 90° Cable glands Progress® nickel-plated brass elbow 90°</p>		<p>70 - 73</p>	<p>2</p>
<p>Winkel 90° Messing mit Innen- und Aussengewinde Elbow 90° nickel-plated brass with internal and external thread</p>		<p>74</p>	<p>3</p>
<p>Winkel 45° Messing mit Innen- und Aussengewinde Elbow 45° nickel-plated brass with internal and external thread</p>		<p>75</p>	<p>4</p>
<p>Flanschwinkel 90° Aluminium Flanged elbow 90° aluminum</p>		<p>76</p>	<p>5</p>
<p>Universal Kabeleinführung für Flach- und Rundkabel Universal cable entry for flat and round cables</p>		<p>77</p>	<p>6</p>
<p>Stopfbuchsen Messing nach DIN 46320-C4-MS Cable glands nickel-plated brass according to DIN 46320-C4-MS</p>		<p>78 - 79</p>	<p>7</p>
<p>Stopfbuchsen Messing mit Klemmbacken Cable glands nickel-plated brass with clamps</p>		<p>80</p>	<p>8</p>
<p>Stopfbuchsen Messing mit Trompete und Klemmbacken Cable glands nickel-plated brass with trumpet and clamps</p>		<p>81</p>	<p>9</p>
<p>Stopfbuchsen Messing mit Schutztülle und Klemmbacken Cable glands nickel-plated brass with antikink nozzle and clamps</p>		<p>82 - 83</p>	<p>10</p>
			<p>11</p>
			<p>12</p>

Kabelverschraubung Progress® ultraFLAT

Cable glands Progress® ultraFLAT

Anschlussgewinde metrisch | Entry thread metric

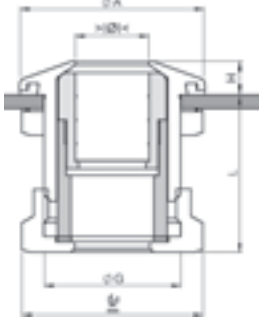

Kabelverschraubungen Progress® ultraFLAT Messing

Frontring:	Messing halbglanz vernickelt
Druckmutter:	Messing vernickelt
Dichtung:	TPE
Dichtscheibe:	FPM
Zugentlastung:	Ausführung A
Einsatztemperatur:	-40°C / +100°C
Schutzart:	IP 68 (bis 10 bar)
Weitere Schutzart:	IP 69K
Wandstärke:	max. 5 mm

Cable glands Progress® ultraFLAT nickel-plated brass

Front part:	semi-bright nickel-plated brass
Push-down nut:	Nickel-plated brass
Seal:	TPE
Sealing washer:	FPM
Strain relief:	Version A
Temperature range:	-40°C / +100°C
Protection class:	IP 68 (up to 10 bar)
Further protection:	IP 69K
Wall thickness:	max. 5 mm



Einteiliger Dichteinsatz
nicht durchgehend isolierend

One-piece sealing insert
not overall length insulated

G	>Ø< min mm	>Ø< max mm	IP	ØA mm	H mm	L mm	Art.-Nr. Art. No.	☐
M16x1.5	5.0	6.5	18	22	4.0	21	1040.17.40.065	25
M16x1.5	6.5	8.0	18	22	4.0	21	1040.17.40.080	25
M20x1.5	6.0	8.0	24	27	4.5	23	1040.20.40.080	25
M20x1.5	8.0	10.5	24	27	4.5	23	1040.20.40.105	25
M25x1.5	8.0	11.0	30	32	5.5	25	1040.25.40.110	20
M25x1.5	11.0	15.0	30	32	5.5	25	1040.25.40.150	20
M32x1.5	12.5	16.0	36	39	6.0	28	1040.32.40.160	10
M32x1.5	16.0	20.5	36	39	6.0	28	1040.32.40.205	10

Auf Anfrage lieferbar:

Rostfreier und säurebeständiger Stahl A4

Available on request:

Stainless steel and acid resistant A4



Anschlussgewinde metrisch | Entry thread metric

Kabelverschraubungen Progress® ultraFLAT rostfreier Stahl A2

Frontring:	Rostfreier Stahl A2
Druckmutter:	Messing vernickelt
Dichtung:	FKM
Dichtscheibe:	FKM
Zugentlastung:	Ausführung A
Einsatztemperatur:	-40°C / +200°C
Schutzart:	IP 68 (bis 10 bar)
Weitere Schutzart:	IP 69K
Wandstärke:	max. 5 mm
Zertifikat:	EHEDG

Cable glands Progress® ultraFLAT stainless steel A2

Front part:	Stainless steel A2
Push-down nut:	Nickel-plated brass
Seal:	FKM
Sealing washer:	FKM
Strain relief:	Version A
Temperature range:	-40°C / +200°C
Protection class:	IP 68 (up to 10 bar)
Further protection:	IP 69K
Wall thickness:	max. 5 mm
Certificate:	EHEDG

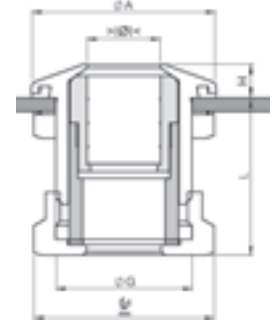

Einteiliger Dichteinsatz
nicht durchgehend isolierend

One-piece sealing insert
not overall length insulated

G	> < < min mm	> < < max mm	IP	∅A mm	H mm	L mm	i info	Art.-Nr. Art. No.	1
M16x1.5	5.0	6.5	18	22	4.0	21	1	1040.17.96.30.065	25
M16x1.5	6.5	8.0	18	22	4.0	21	1	1040.17.96.30.080	25
M20x1.5	6.0	8.0	24	27	4.5	23	1	1040.20.96.30.080	25
M20x1.5	8.0	10.5	24	27	4.5	23	1	1040.20.96.30.105	25
M25x1.5	8.0	11.0	30	32	5.5	25	1	1040.25.96.30.110	20
M25x1.5	11.0	15.0	30	32	5.5	25	1	1040.25.96.30.150	20
M32x1.5	12.5	16.0	36	39	6.0	28	1	1040.32.96.30.160	10
M32x1.5	16.0	20.5	36	39	6.0	28	1	1040.32.96.30.205	10

1 = Lieferbar auf Anfrage
FDA konforme Dichtungen

1 = Available on request
FDA cleared sealing inserts



Anschlussgewinde metrisch | Entry thread metric

Kabelverschraubungen Progress ultraFLAT rostfreier Stahl A2 für hohe Temperaturen

Frontring:	Rostfreier Stahl A2
Druckmutter:	Messing vernickelt
Dichtung:	FPM
Dichtscheibe:	FPM
Zugentlastung:	Ausführung A
Einsatztemperatur:	-40°C / +200°C
Schutzart:	IP 68 (bis 10 bar)
Weitere Schutzart:	IP 69K
Wandstärke:	max. 5 mm

Cable glands Progress® ultraFLAT stainless steel A2 for high temperature applications

Front part:	Stainless steel A2
Push-down nut:	Nickel-plated brass
Seal:	FPM
Sealing washer:	FPM
Strain relief:	Version A
Temperature range:	-40°C / +200°C
Protection class:	IP 68 (up to 10 bar)
Further protection:	IP 69K
Wall thickness:	max. 5 mm

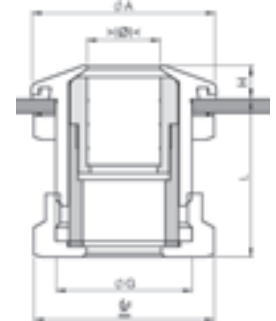

Einteiliger Dichteinsatz
nicht durchgehend isolierend

One-piece sealing insert
not overall length insulated

G	> < < min mm	> < < max mm	IP	∅A mm	H mm	L mm	i info	Art.-Nr. Art. No.	1
M16x1.5	5.0	6.5	18	22	4.0	21	-	1040.17.96.70.065	25
M16x1.5	6.5	8.0	18	22	4.0	21	-	1040.17.96.70.080	25
M20x1.5	6.0	8.0	24	27	4.5	23	1	1040.20.96.70.080	25
M20x1.5	8.0	10.5	24	27	4.5	23	-	1040.20.96.70.105	25
M25x1.5	8.0	11.0	30	32	5.5	25	1	1040.25.96.70.110	20
M25x1.5	11.0	15.0	30	32	5.5	25	-	1040.25.96.70.150	20
M32x1.5	12.5	16.0	36	39	6.0	28	1	1040.32.96.70.160	10
M32x1.5	16.0	20.5	36	39	6.0	28	-	1040.32.96.70.205	10

1 = Lieferbar auf Anfrage

1 = Available on request



Kabelverschraubungen Progress® Messing Winkel 90°

Cable glands Progress® nickel-plated brass elbow 90°

Kurzes Anschlussgewinde metrisch | Short entry thread metric

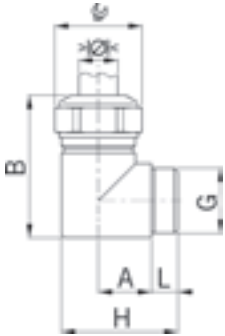

Material: Messing vernickelt
 Dichtung: TPE
 Zugentlastung: Ausführung A
 Einsatztemperatur: -40°C / +100°C
 Schutzart: IP 68
 Gewinde: IP 68, wenn Anschlussgewinde abgedichtet

Material: Nickel-plated brass
 Seal: TPE
 Strain relief: Version A
 Temperature range: -40°C / +100°C
 Protection class: IP 68
 Entry thread: IP 68, if the entry thread is sealed



Progress MS W90



Einteiliger Dichteinsatz
 nicht durchgehend isolierend

One-piece sealing insert
 not overall length insulated

G	$\begin{matrix} > \varnothing < \\ \text{min mm} \end{matrix}$	$\begin{matrix} > \varnothing < \\ \text{max mm} \end{matrix}$		H mm	L mm	A mm	B mm	Art.-Nr. Art. No.	
M12x1.5	5.0	6.5	15	27	8	11	32	5200.12	50

Erhältlich mit Dichteinsatz gemäss EN 45545. Bei Anfragen oder Bestellung bitte ein F vor die Artikelnummer setzen.

Available with sealing inserts conformity with EN 45545. When placing an inquiry, prefix the article number by the capital F.

Progress MS W90



Zweiteiliger Dichteinsatz
 nicht durchgehend isolierend

Two-piece sealing insert
 not overall length insulated

G	$\begin{matrix} > \varnothing < \\ \text{min mm} \end{matrix}$	$\begin{matrix} > \varnothing < \\ \text{max mm} \end{matrix}$		H mm	L mm	A mm	B mm	Art.-Nr. Art. No.	
M16x1.5	6.0	10.5	18	30	8	13	36	5200.17	50
M20x1.5	8.0	15.0	24	35	8	16	44	5200.20	50
M25x1.5	12.5	20.5	30	44	10	20	52	5200.25	25
M32x1.5	17.0	25.5	36	50	10	23	60	5200.32	25
M40x1.5	24.0	33.0	46	60	10	28	72	5200.40	10

Erhältlich mit Dichteinsatz gemäss EN 45545. Bei Anfragen oder Bestellung bitte ein F vor die Artikelnummer setzen.

Available with sealing inserts conformity with EN 45545. When placing an inquiry, prefix the article number by the capital F.

Langes Anschlussgewinde metrisch | Long entry thread metric



Progress MS W90

Einteiliger Dichteinsatz
 nicht durchgehend isolierend

One-piece sealing insert
 not overall length insulated

G	$\begin{matrix} > \varnothing < \\ \text{min mm} \end{matrix}$	$\begin{matrix} > \varnothing < \\ \text{max mm} \end{matrix}$		H mm	L mm	A mm	B mm	Art.-Nr. Art. No.	
M12x1.5	5.0	6.5	15	30	12	11	32	5210.12	50

Erhältlich mit Dichteinsatz gemäss EN 45545. Bei Anfragen oder Bestellung bitte ein F vor die Artikelnummer setzen.

Available with sealing inserts conformity with EN 45545. When placing an inquiry, prefix the article number by the capital F.

Progress MS W90



Zweiteiliger Dichteinsatz
 nicht durchgehend isolierend

Two-piece sealing insert
 not overall length insulated

G	$\begin{matrix} > \varnothing < \\ \text{min mm} \end{matrix}$	$\begin{matrix} > \varnothing < \\ \text{max mm} \end{matrix}$		H mm	L mm	A mm	B mm	Art.-Nr. Art. No.	
M16x1.5	6.0	10.5	18	34	12	13	36	5210.17	50
M20x1.5	8.0	15.0	24	39	12	16	44	5210.20	50
M25x1.5	12.5	20.5	30	48	14	20	52	5210.25	25
M32x1.5	17.0	25.5	36	56	16	23	60	5210.32	25
M40x1.5	24.0	33.0	46	66	16	28	72	5210.40	10

Erhältlich mit Dichteinsatz gemäss EN 45545. Bei Anfragen oder Bestellung bitte ein F vor die Artikelnummer setzen.

Available with sealing inserts conformity with EN 45545. When placing an inquiry, prefix the article number by the capital F.

Kabelverschraubungen Progress® Messing Winkel 90°

Cable glands Progress® nickel-plated brass elbow 90°

Kurzes Anschlussgewinde Pg | Short entry thread Pg

Material: Messing vernickelt
 Dichtung: TPE
 Einsatztemperatur: -40°C / +100°C
 Schutzart: IP 68
 Gewinde: IP 68, wenn Anschluss-
 gewinde abgedichtet

Material: Nickel-plated brass
 Seal: TPE
 Temperature range: -40°C / +100°C
 Protection class: IP 68
 Entry thread: IP 68, if the entry thread
 is sealed

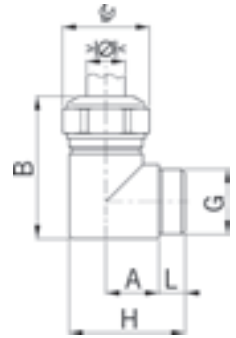

Progress MS W90



Einteiliger Dichteinsatz
 nicht durchgehend isolierend

One-piece sealing insert
 not overall length insulated

G	> Ø < min mm	> Ø < max mm		H mm	L mm	A mm	B mm	Art.-Nr. Art. No.	
Pg 7	5.0	6.5	15	27	8	11	32	5200.07	50

Erhältlich mit Dichteinsatz gemäss EN 45545. Bei Anfragen
 oder Bestellung bitte ein F vor die Artikelnummer setzen.

Available with sealing inserts conformity with EN 45545.
 When placing an inquiry, prefix the article number by the
 capital F.



Progress MS W90



Zweiteiliger Dichteinsatz
 nicht durchgehend isolierend

Two-piece sealing insert
 not overall length insulated

G	> Ø < min mm	> Ø < max mm		H mm	L mm	A mm	B mm	Art.-Nr. Art. No.	
Pg 9	6.0	10.5	18	30	8	13	36	5200.09	50
Pg 11	5.5	12.0	21	35	8	14	40	5200.11	50
Pg 13	8.0	15.0	24	41	10	16	44	5200.13	50
Pg 16	8.0	15.0	24	41	10	16	44	5200.16	50
Pg 21	12.5	20.5	30	44	10	20	52	5200.21	25
Pg 29	19.0	27.5	38	56	10	24	65	5200.29	10

Erhältlich mit Dichteinsatz gemäss EN 45545. Bei Anfragen
 oder Bestellung bitte ein F vor die Artikelnummer setzen.

Available with sealing inserts conformity with EN 45545.
 When placing an inquiry, prefix the article number by the
 capital F.



Langes Anschlussgewinde Pg | Long entry thread Pg

Progress MS W90



Einteiliger Dichteinsatz
 nicht durchgehend isolierend

One-piece sealing insert
 not overall length insulated

G	> Ø < min mm	> Ø < max mm		H mm	L mm	A mm	B mm	Art.-Nr. Art. No.	
Pg 7	5.0	6.5	15	30	11	11	32	5210.07	50

Erhältlich mit Dichteinsatz gemäss EN 45545. Bei Anfragen
 oder Bestellung bitte ein F vor die Artikelnummer setzen.

Available with sealing inserts conformity with EN 45545.
 When placing an inquiry, prefix the article number by the
 capital F.



Progress MS W90



Zweiteiliger Dichteinsatz
 nicht durchgehend isolierend

Two-piece sealing insert
 not overall length insulated

G	> Ø < min mm	> Ø < max mm		H mm	L mm	A mm	B mm	Art.-Nr. Art. No.	
Pg 9	6.0	10.5	18	34	11	13	36	5210.09	50
Pg 11	5.5	12.0	21	38	11	14	40	5210.11	50
Pg 13	8.0	15.0	24	44	13	16	44	5210.13	50
Pg 16	8.0	15.0	24	44	13	16	44	5210.16	50
Pg 21	12.5	20.5	30	48	14	20	52	5210.21	25
Pg 29	19.0	27.5	38	60	14	24	65	5210.29	10

Erhältlich mit Dichteinsatz gemäss EN 45545. Bei Anfragen
 oder Bestellung bitte ein F vor die Artikelnummer setzen.

Available with sealing inserts conformity with EN 45545.
 When placing an inquiry, prefix the article number by the
 capital F.



Kabelverschraubungen Progress® Messing Winkel 90°

Cable glands Progress® nickel-plated brass elbow 90°

Langes Anschlussgewinde metrisch mit Gegenmutter | Long entry thread metric with lock nut

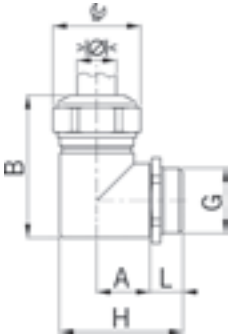

Material: Messing vernickelt
 Dichtung: TPE
 O-Ring : NBR
 Zugentlastung: Ausführung A
 Einsatztemperatur: -40°C / +100°C
 Schutzart: IP 68

Material: Nickel-plated brass
 Seal: TPE
 O-ring : NBR
 Strain relief: Version A
 Temperature range: -40°C / +100°C
 Protection class: IP 68



Progress MS W90



Einteiliger Dichteinsatz
 nicht durchgehend isolierend

One-piece sealing insert
 not overall length insulated

G	$> \varnothing <$ min mm	$> \varnothing <$ max mm		H mm	L mm	A mm	B mm	Art.-Nr. Art. No.	
M12x1.5	5.0	6.5	15	30	12	11	32	5215.12	50

Erhältlich mit Dichteinsatz gemäss EN 45545. Bei Anfragen oder Bestellung bitte ein F vor die Artikelnummer setzen.

Available with sealing inserts conformity with EN 45545. When placing an inquiry, prefix the article number by the capital F.



Progress MS W90



Zweiteiliger Dichteinsatz
 nicht durchgehend isolierend

Two-piece sealing insert
 not overall length insulated

G	$> \varnothing <$ min mm	$> \varnothing <$ max mm		H mm	L mm	A mm	B mm	Art.-Nr. Art. No.	
M16x1.5	6.0	10.5	18	34	12	13	36	5215.17	50
M20x1.5	8.0	15.0	24	39	12	16	44	5215.20	50
M25x1.5	12.5	20.5	30	48	14	20	52	5215.25	25
M32x1.5	17.0	25.5	36	56	16	23	60	5215.32	25
M40x1.5	24.0	33.0	46	66	16	28	72	5215.40	10

Erhältlich mit Dichteinsatz gemäss EN 45545. Bei Anfragen oder Bestellung bitte ein F vor die Artikelnummer setzen.

Available with sealing inserts conformity with EN 45545. When placing an inquiry, prefix the article number by the capital F.

Kabelverschraubungen Progress® Messing Winkel 90°

Cable glands Progress® nickel-plated brass elbow 90°

Langes Anschlussgewinde Pg mit Gegenmutter | Long entry thread Pg with lock nut

Material: Messing vernickelt
 Dichtung: TPE
 O-Ring : NBR
 Einsatztemperatur: -40°C / +100°C
 Schutzart: IP 68

Material: Nickel-plated brass
 Seal: TPE
 O-ring : NBR
 Temperature range: -40°C / +100°C
 Protection class: IP 68

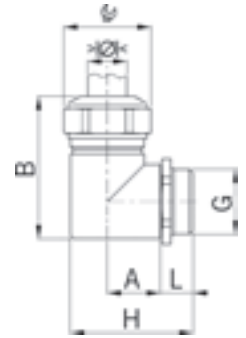

Progress MS W90



Einteiliger Dichteinsatz
 nicht durchgehend isolierend

One-piece sealing insert
 not overall length insulated

G	> Ø < min mm	> Ø < max mm		H mm	L mm	A mm	B mm	Art.-Nr. Art. No.	
Pg 7	5.0	6.5	15	30	11	11	32	5215.07	50

Erhältlich mit Dichteinsatz gemäss EN 45545. Bei Anfragen oder Bestellung bitte ein F vor die Artikelnummer setzen.

Available with sealing inserts conformity with EN 45545. When placing an inquiry, prefix the article number by the capital F.



Progress MS W90



Zweiteiliger Dichteinsatz
 nicht durchgehend isolierend

Two-piece sealing insert
 not overall length insulated

G	> Ø < min mm	> Ø < max mm		H mm	L mm	A mm	B mm	Art.-Nr. Art. No.	
Pg 9	6.0	10.5	18	34	11	13	36	5215.09	50
Pg 11	5.5	12.0	21	38	11	14	40	5215.11	50
Pg 13	8.0	15.0	24	44	13	16	44	5215.13	50
Pg 16	8.0	15.0	24	44	13	16	44	5215.16	50
Pg 21	12.5	20.5	30	48	14	20	52	5215.21	25
Pg 29	19.0	27.5	38	60	14	24	65	5215.29	10

Erhältlich mit Dichteinsatz gemäss EN 45545. Bei Anfragen oder Bestellung bitte ein F vor die Artikelnummer setzen.

Available with sealing inserts conformity with EN 45545. When placing an inquiry, prefix the article number by the capital F.



Winkel 90° Messing mit Innen- und Aussengewinde

Elbow 90° nickel-plated brass with internal and external thread

Anschlussgewinde metrisch | Entry thread metric

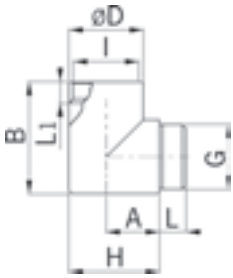

Material: Messing vernickelt
 O-Ring : NBR
 Einsatztemperatur: -40°C / +100°C
 Schutzart: IP 54
 Weitere Schutzart: IP 68, wenn Anschluss-
 gewinde abgedichtet

Material: Nickel-plated brass
 O-ring : NBR
 Temperature range: -40°C / +100°C
 Protection class: IP 54
 Further protection: IP 68, if the entry thread
 is sealed



mit O-Ring		with O-ring						Art.-Nr. Art. No.	
G	I	D mm	L mm	L1 mm	A mm	B mm	H mm		
M12x1.5	M12x1.5	15	5.0	7	13	25	20	5612	50
M16x1.5	M16x1.5	19	6.5	7	16	29	26	5617	50
M20x1.5	M20x1.5	24	6.0	10	19	37	31	5620	50
M25x1.5	M25x1.5	29	7.5	10	23	42	37	5625	25
M32x1.5	M32x1.5	36	8.5	11	26	50	44	5632	25
M40x1.5	M40x1.5	46	9.5	17	34	67	57	5640	10
M50x1.5	M50x1.5	56	9.0	17	41	77	69	5650	10

Anschlussgewinde Pg | Entry thread Pg



mit O-Ring		with O-ring						Art.-Nr. Art. No.	
G	I	D mm	L mm	L1 mm	A mm	B mm	H mm		
Pg 7	Pg 7	16	7	7	13	23	21	5607	50
Pg 9	Pg 9	18	7	7	15	26	24	5609	50
Pg 11	Pg 11	22	8	8	18	31	29	5611	50
Pg 13	Pg 13	24	10	10	19	34	31	5613	50
Pg 16	Pg 16	26	10	10	20	36	33	5616	50
Pg 21	Pg 21	34	11	11	24	46	41	5621	25
Pg 29	Pg 29	41	11	11	28	52	49	5629	20
Pg 36	Pg 36	52	12	17	38	82	64	5636	10

Winkel 45° Messing mit Innen- und Aussengewinde Elbows 45° nickel-plated brass with internal and external thread

Anschlussgewinde metrisch | Entry thread metric

Material: Messing vernickelt
 O-Ring : NBR
 Einsatztemperatur: -40°C / +100°C
 Schutzart: IP 54
 Weitere Schutzart: IP 68, wenn Anschluss-
 gewinde abgedichtet

Material: Nickel-plated brass
 O-ring : NBR
 Temperature range: -40°C / +100°C
 Protection class: IP 54
 Further protection: IP 68, if the entry thread
 is sealed

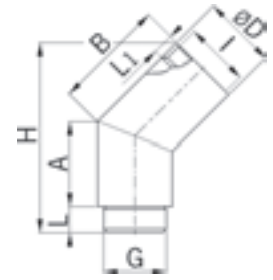

mit O-Ring								with O-ring		
G	I	D mm	L mm	L1 mm	A mm	B mm	H mm	Art.-Nr. Art. No.		
M16x1.5	M16x1.5	19	6.5	7	13	18	26	5717	50	
M20x1.5	M20x1.5	24	6.0	10	17	23	33	5720	50	
M25x1.5	M25x1.5	29	7.5	10	18	25	36	5725	25	
M32x1.5	M32x1.5	36	8.5	11	21	28	41	5732	25	



Anschlussgewinde Pg | Entry thread Pg

mit O-Ring								with O-ring		
G	I	D mm	L mm	L1 mm	A mm	B mm	H mm	Art.-Nr. Art. No.		
Pg 11	Pg 11	22	8	11	16	20	30	5711	50	
Pg 16	Pg 16	26	10	12	18	23	34	5716	50	
Pg 21	Pg 21	34	11	12	21	26	39	5721	25	
Pg 29	Pg 29	41	8	16	27	32	-	5729	25	



Flanschwinkel 90° Zinkdruckguss

Flanged elbow 90° zinc diecasting

Anschlussgewinde metrisch | Entry thread metric

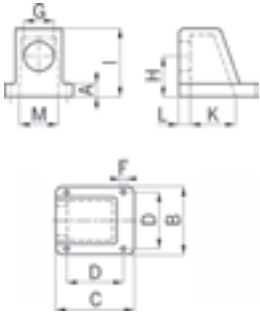

Material: Zinkdruckguss
 Dichtung: NBR
 Einsatztemperatur: -40°C / +100°C
 Schutzart: IP 65
 Eigenschaften: Für spritzwasserdichte Montage an der Gehäusewandung mit Anschlussgewinde für Kabelverschraubung oder Schlauchverschraubung

Material: Zinc diecasting
 Seal: NBR
 Temperature range: -40°C / +100°C
 Protection class: IP 65
 Properties: For splash water-proof mounting on casing walls with entry thread for cable glands or conduit glands



mit 1 Anschlussgewinde										with 1 entry thread									
G	B/C mm	D mm	F mm	A mm	H mm	I mm	K mm	L mm	M mm	Art.-Nr. Art. No.									
M16x1.5	45 x 48	37	4.3	8	15.5	30	28	10.5	24	5517		10							
M20x1.5	53 x 56	44	5.5	8	18.0	35	34	10.5	24	5520		10							
M25x1.5	63 x 65	54	5.5	8	22.5	42	43	11.0	35	5525		5							
M32x1.5	71 x 75	60	5.5	10	27.0	52	53	11.0	38	5532		5							
M40x1.5	71 x 75	60	5.5	10	27.0	52	53	11.0	38	5540		5							
M50x1.5	89 x 93	72	6.5	11	33.5	69	65	18.0	50	5550		2							
M63x1.5	96 x 114	84	4.3	10	37.0	74	86	14.0	67	5563		2							

Anschlussgewinde Pg | Entry thread Pg



mit 1 Anschlussgewinde										with 1 entry thread									
G	B/C mm	D mm	F mm	A mm	H mm	I mm	K mm	L mm	M mm	Art.-Nr. Art. No.									
Pg 9	45 x 48	37	4.3	8	15.5	30	28	10.5	24	5509		10							
Pg 13	53 x 56	44	5.5	8	19.0	35	34	10.5	24	5513		10							
Pg 16	53 x 56	44	5.5	8	19.0	35	34	10.5	24	5516		10							
Pg 21	63 x 65	54	5.5	8	23.0	42	43	11.0	35	5521		10							
Pg 29	71 x 75	60	5.5	10	27.0	52	53	11.0	38	5529		10							
Pg 36	89 x 94	72	6.5	11	34.0	69	65	18.0	50	5536		10							

Anschlussgewinde Pg | Entry thread Pg

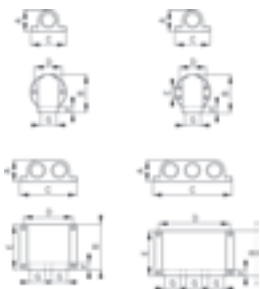

Material: Zinkdruckguss
 Farbe: Hammerschlaglackiert grau
 Dichtung: NBR
 Einsatztemperatur: -40°C / +100°C
 Schutzart: IP 65
 Eigenschaften: Für spritzwasserdichte Montage an der Gehäusewandung mit Anschlussgewinde für Kabelverschraubung oder Schlauchverschraubung

Material: Zinc diecasting
 Colour: Hammergrey enamel
 Seal: NBR
 Temperature range: -40°C / +100°C
 Protection class: IP 65
 Properties: For splash water-proof mounting on casing walls with entry thread for cable glands or conduit glands



Mit 1 bis 3 Anschlussgewinden										With 1 to 3 entry threads									
G		A mm	B mm	C mm	D mm	E mm	F mm			Art.-Nr. Art. No.									
Pg 16	1 x	31	42	42	36.0	-	11	2x4.5		5516.10		10							
Pg 21	1 x	40	60	60	52.5	-	12	2x5.2		5521.10		10							
Pg 29	1 x	51.5	76	66	54.0	36	12	4x5.5		5529.10		10							
Pg 36	1 x	62	90	85	73.0	30	12	4x5.5		5536.10		10							
Pg 16	2 x	34	70	91	79.0	58	10	4x5.5		5516.12		10							
Pg 16	3 x	34	70	124	111.0	56	10	4x5.5		5516.13		10							

Universal Kabeleinführung für Flach- und Rundkabel

Universal cable entry for flat and round cables

Für Flach- und Rundkabel | For flat and round cables

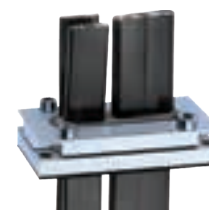
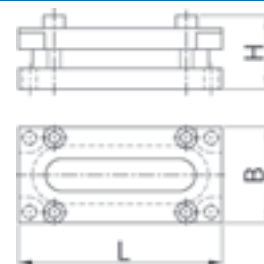

Material: Alu (AlMgSi0.5)
 Eigenschaften: Universal für ein oder mehrere Kabel, auch mit verschiedenen Abmessungen und Durchmessern. Max. Einbau von Flachkabeln 70x12 mm.
 Dichtung: NBR
 Einsatztemperatur: -40°C / +100°C
 Schutzart: IP 54 - IP 68

Material: Alu (AlMgSi0.5)
 Properties: Universally applicable for one or several cable(s) with various dimensions and diameters. Max. cable dimension 70x12 mm.
 Seal: NBR
 Temperature range: -40°C / +100°C
 Protection class: IP 54 - IP 68



Aluminium Gehäuse zweiteilig
 Mit Dichtscheibe
 Universeller Dichtungseinsatz

Two-piece aluminium housing
 With sealing washer
 Universal sealing insert

L x B mm	 mm	H mm	Art.-Nr. Art. No.	
95x45	70.0x12.0	35	1370.15	5
95x45	49.0x4.5	35	1370.15.49.04	5
95x45	2x49.0x4.5	35	1370.15.49.45	5
95x45	63.0x12.0	35	1370.15.63.12	5
95x45	max.70.0x12.0	35	1370.15.30	5

Technischer Hinweis

Vollgummi-Dichteinsätze auf die entsprechende Kabeldimension aufbohren (Rundkabel $\varnothing +1$ mm)

Dichteinsätze ohne Bohrung lassen sich gut bearbeiten, wenn sie vorher auf mindestens -25°C gefroren wurden.

Technical note

Drill solid rubber inserts to match the appropriate cable diameter (round cables $\varnothing +1$ mm)

When frozen to at least -25°C, the solid sealing inserts are easy to drill.

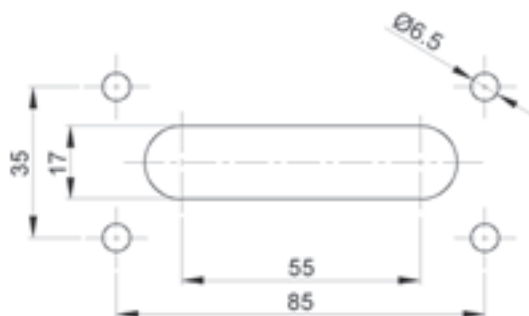

Stopfbuchsen Messing nach DIN 46320-C4-MS

Cable glands nickel-plated brass according to DIN 46320-C4-MS

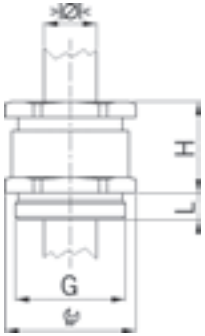

Kurzes Anschlussgewinde metrisch | Short entry thread metric



Material: Messing vernickelt
 Dichtung: NBR
 Einsatztemperatur: -20°C / +80°C
 Schutzart: IP 54



Material: Nickel-plated brass
 Seal: NBR
 Temperature range: -20°C / +80°C
 Protection class: IP 54



Einteiliger Einschnittring nicht durchgehend isolierend		One piece sealing ring not overall length insulated				Art.-Nr. Art. No.	
G	$\begin{matrix} > \varnothing < \\ \text{min mm} \end{matrix}$	$\begin{matrix} > \varnothing < \\ \text{max mm} \end{matrix}$		H mm	L mm		
M12x1.5	5.0	7.0	14/13	15	5	B 112	100
M16x1.5	6.0	8.0	18/15	15	5	B 117	100
M20x1.5	8.0	10.0	22/18	19	6	B 120.10	50
M20x1.5	10.0	12.0	22/20	19	6	B 120.12	50
M20x1.5	12.0	14.0	22/20	19	6	B 120.14	50
M25x1.5	15.0	17.0	30/28	23	7	B 125	50
M32x1.5	24.0	26.0	40/37	26	8	B 132	25
M40x1.5	33.0	35.0	50/47	30	8	B 140	20
M50x1.5	39.0	41.0	57/54	34	9	B 150	10
M63x1.5	45.0	47.0	66/60	35	10	B 163	10

Langes Anschlussgewinde metrisch | Long entry thread metric



Einteiliger Einschnittring nicht durchgehend isolierend		One piece sealing ring not overall length insulated				Art.-Nr. Art. No.	
G	$\begin{matrix} > \varnothing < \\ \text{min mm} \end{matrix}$	$\begin{matrix} > \varnothing < \\ \text{max mm} \end{matrix}$		H mm	L mm		
M12x1.5	5.0	7.0	14/13	15	10	B 212	100
M16x1.5	6.0	8.0	18/15	15	10	B 217	100
M20x1.5	8.0	10.0	22/18	19	10	B 220.10	50
M20x1.5	10.0	12.0	22/20	19	10	B 220.12	50
M20x1.5	12.0	14.0	22/20	19	10	B 220.14	50
M25x1.5	15.0	17.0	30/28	23	12	B 225	50
M32x1.5	24.0	26.0	40/37	26	12	B 232	25
M40x1.5	33.0	35.0	50/47	30	14	B 240	20
M50x1.5	39.0	41.0	57/54	34	14	B 250	10
M63x1.5	45.0	47.0	66/60	35	14	B 263	10

Stopfbuchsen Messing nach DIN 46320-C4-MS

Cable glands nickel-plated brass according to DIN 46320-C4-MS

Kurzes Anschlussgewinde Pg | Short entry thread Pg

Material: Messing vernickelt
 Dichtung: NBR
 Einsatztemperatur: -20°C / +80°C
 Schutzart: IP 54

Material: Nickel-plated brass
 Seal: NBR
 Temperature range: -20°C / +80°C
 Protection class: IP 54

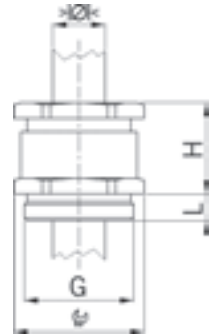

Einteiliger Einschnittring nicht durchgehend isolierend		One piece sealing ring not overall length insulated				Art.-Nr. Art. No.	
G	>Ø< min mm	>Ø< max mm		H mm	L mm		
Pg 7	6.0	8.0	14/13	15	5	B 107	50
Pg 9	4.0	10.0	17/15	15	5	B 109	50
Pg 11	6.5	12.0	20/18	17	6	B 111	50
Pg 13	6.5	13.5	22/20	20	6	B 113	50
Pg 16	6.5	16.0	24/22	22	6	B 116	50
Pg 21	9.0	20.0	30/28	24	7	B 121	50
Pg 29	17.0	28.0	40/37	26	8	B 129	25
Pg 36	23.0	34.0	50/47	30	9	B 136	10
Pg 42	29.0	40.0	57/54	34	10	B 142	10
Pg 48	35.0	46.0	64/60	37	10	B 148.48	10



Langes Anschlussgewinde Pg | Long entry thread Pg

Einteiliger Einschnittring nicht durchgehend isolierend		One piece sealing ring not overall length insulated				Art.-Nr. Art. No.	
G	>Ø< min mm	>Ø< max mm		H mm	L mm		
Pg 9	4.0	10.0	17/15	15	15	B 209	50
Pg 11	6.5	12.0	20/18	17	15	B 211	50
Pg 13	6.5	13.5	22/20	20	15	B 213	50
Pg 16	6.5	16.0	24/22	22	15	B 216	50
Pg 21	9.0	20.0	30/28	24	15	B 221	50
Pg 29	17.0	28.0	40/37	26	15	B 229	25
Pg 36	23.0	34.0	50/47	30	15	B 236	10
Pg 42	29.0	40.0	57/54	34	15	B 242	10
Pg 48	35.0	46.0	64/60	37	15	B 248.48	10



Stopfbuchsen Messing mit Klemmbacken

Cable glands nickel-plated brass with clamps

Kurzes Anschlussgewinde metrisch | Short entry thread metric

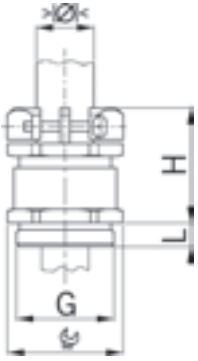



Material: Messing vernickelt
 Dichtung: NBR
 Einsatztemperatur: -20°C / +80°C
 Schutzart: IP 54

Material: Nickel-plated brass
 Seal: NBR
 Temperature range: -20°C / +80°C
 Protection class: IP 54



Einteiliger Einschnittring
 nicht durchgehend isolierend

One piece sealing ring
 not overall length insulated



G	> Ø < min mm	> Ø < max mm		H mm	L mm	Art.-Nr. Art. No.	
M12x1.5	5.0	7.0	14/17	22	5	1803.12	50
M16x1.5	6.0	8.0	17/20	25	6	1803.17	50
M20x1.5	8.0	10.0	24/27	26	6	1803.20	50
M25x1.5	15.0	17.0	30/35	28	6	1803.25	25
M32x1.5	24.0	26.0	40/43	29	6	1803.32	25
M40x1.5	33.0	35.0	50/55	33	7	1803.40	10

Kurzes Anschlussgewinde Pg | Short entry thread Pg



Einteiliger Einschnittring
 nicht durchgehend isolierend

One piece sealing ring
 not overall length insulated

G	> Ø < min mm	> Ø < max mm		H mm	L mm	Art.-Nr. Art. No.	
Pg 7	6.0	8.0	14/16	22	5	1803.07	50
Pg 9	8.0	10.0	17/19	25	6	1803.09	50
Pg 11	10.0	12.0	20/22	26	6	1803.11	50
Pg 13	12.0	14.0	22/24	27.5	6.5	1803.13	50
Pg 16	14.0	16.0	24/27	28.5	6.5	1803.16	50
Pg 21	14.0	16.0	30/34	33	7	1803.21	25
Pg 29	24.0	26.0	40/42	36	8	1803.29	25
Pg 36	30.0	32.0	50/52	41	9	1803.36	10
Pg 42	39.0	41.0	57/59	45	10	1803.42	10
Pg 48	45.0	47.0	64/64	48	10	1803.48.48	10

Stopfbuchsen Messing mit Trompete und Klemmbacken

Cable glands nickel-plated brass with trumpet and clamps

Kurzes Anschlussgewinde metrisch | Short entry thread metric

Material: Messing vernickelt
 Dichtung: NBR
 Einsatztemperatur: -20°C / +80°C
 Schutzart: IP 54

Material: Nickel-plated brass
 Seal: NBR
 Temperature range: -20°C / +80°C
 Protection class: IP 54



Einteiliger Einschnittring nicht durchgehend isolierend						One piece sealing ring not overall length insulated			
G	>Ø< min mm	>Ø< max mm		H mm	L mm	ØA mm	Art.-Nr. Art. No.		
M16x1.5	6.0	8.0	18/17	29	5	22	1801.17		50
M20x1.5	8.0	10.0	22/20	31	6	26	1801.20.10		50
M20x1.5	10.0	12.0	22/22	32	6	29	1801.20.12		50
M20x1.5	12.0	14.0	22/24	34	6	32	1801.20.14		50
M25x1.5	15.0	17.0	30/30	37	7	38	1801.25		50
M32x1.5	24.0	26.0	40/41	43	8	50	1801.32		25



Kurzes Anschlussgewinde Pg | Short entry thread Pg

Einteiliger Einschnittring nicht durchgehend isolierend						One piece sealing ring not overall length insulated			
G	>Ø< min mm	>Ø< max mm		H mm	L mm	ØA mm	Art.-Nr. Art. No.		
Pg 9	6.0	9.0	17	29	6	22	1801.09		50
Pg 11	8.0	12.0	20	31	6	26	1801.11		50
Pg 13	9.0	14.0	22	32	6	29	1801.13		50
Pg 16	10.0	16.0	24	34	6	32	1801.16		50
Pg 21	14.0	21.0	30	37	7	38	1801.21		50
Pg 29	18.0	30.0	40	43	8	50	1801.29		25



Stopfbuchsen Messing mit Schutztülle und Klemmbacken

Cable glands nickel-plated brass with antikink nozzle and clamps

Kurzes Anschlussgewinde metrisch | Short entry thread metric





Material: Messing vernickelt
 Dichtung: NBR
 Knickschutztülle: NBR
 Einsatztemperatur: -20°C / +80°C
 Schutzart: IP 65 wenn Anschluss-
 gewinde abgedichtet

Material: Nickel-plated brass
 Seal: NBR
 antikink nozzle: NBR
 Temperature range: -20°C / +80°C
 Protection class: IP 65 if the entry thread
 is sealed



Einteiliger Einschnittring
 nicht durchgehend isolierend

One piece sealing ring
 not overall length insulated

G	> Ø < min mm	> Ø < max mm		H mm	L mm	Art.-Nr. Art. No.	
M12x1.5	3.5	5.0	14/15	43	5	1852.12.05	25
M16x1.5	5.5	7.0	17/18	44	6	1852.16.07	25
M20x1.5	5.5	7.0	20/22	49	6	1852.20.07	25
M20x1.5	7.5	9.0	20/22	49	6	1852.20.09	25
M20x1.5	9.0	11.0	22/22	54	6	1852.20.11	25
M20x1.5	11.0	13.0	22/22	54	6	1852.20.13	25
M20x1.5	13.0	15.0	24/24	58	6	1852.20.15	25
M25x1.5	13.5	15.0	30/30	71	7	1852.25.15	25
M25x1.5	15.0	17.0	30/30	71	7	1852.25.17	25
M25x1.5	17.0	19.0	30/30	71	7	1852.25.19	25
M25x1.5	18.0	20.0	30/30	71	7	1852.25.20	25
M32x1.5	21.0	23.0	40/40	81	8	1852.32.23	1
M32x1.5	23.0	25.0	40/40	81	8	1852.32.25	1
M40x1.5	23.0	26.0	50/50	99	9	1852.40.26	1
M40x1.5	27.0	30.0	50/50	99	9	1852.40.30	1
M40x1.5	30.0	33.0	50/50	99	9	1852.40.33	1
M40x1.5	32.0	35.0	50/50	99	9	1852.40.35	1

Stopfbuchsen Messing mit Schutztülle und Klemmbacken

Cable glands nickel-plated brass with antikink nozzle and clamps

Kurzes Anschlussgewinde Pg | Short entry thread Pg



Material: Messing vernickelt
 Dichtung: NBR
 Knickschutztülle: NBR
 Einsatztemperatur: -20°C / +80°C
 Schutzart: IP 65 wenn Anschluss-
 gewinde abgedichtet

Material: Nickel-plated brass
 Seal: NBR
 antikink nozzle: NBR
 Temperature range: -20°C / +80°C
 Protection class: IP 65 if the entry thread
 is sealed



Einteiliger Einschnittring
 nicht durchgehend isolierend

One piece sealing ring
 not overall length insulated

G	> Ø < min mm	> Ø < max mm		H mm	L mm	Art.-Nr. Art. No.	
Pg 7	3.5	5.0	14/16	46	5	1852.07.05	50
Pg 9	5.5	7.0	17/19	45	6	1852.09.07	50
Pg 11	5.5	7.0	20/22	45	6	1852.11.07	50
Pg 11	7.5	9.0	20/22	49	6	1852.11.09	50
Pg 13	7.5	9.0	22/24	54	6	1852.13.09	25
Pg 13	9.0	11.0	22/24	54	6	1852.13.11	25
Pg 13	11.0	13.0	22/24	54	6	1852.13.13	25
Pg 16	11.5	13.0	24/27	58	6	1852.16.13	25
Pg 16	13.0	15.0	24/27	58	6	1852.16.15	25
Pg 21	13.5	15.0	30/34	71	7	1852.21.15	25
Pg 21	15.0	17.0	30/34	71	7	1852.21.17	25
Pg 21	17.0	19.0	30/34	71	7	1852.21.19	25
Pg 21	18.0	20.0	30/34	71	7	1852.21.20	25
Pg 29	18.0	20.0	40/42	71	8	1852.29.20	1
Pg 29	21.0	23.0	40/42	82	8	1852.29.23	1
Pg 29	23.0	25.0	40/42	82	8	1852.29.25	1
Pg 36	23.0	26.0	50/52	101	9	1852.36.26	1
Pg 36	27.0	30.0	50/52	101	9	1852.36.30	1
Pg 36	30.0	33.0	50/52	99	9	1852.36.33	1
Pg 36	32.0	35.0	50/52	99	9	1852.36.35	1
Pg 42	32.0	35.0	57/62	104	10	1852.42.35	1
Pg 42	35.0	38.0	57/62	104	10	1852.42.38	1
Pg 42	36.0	40.0	57/62	104	10	1852.42.40	1
Pg 48	36.0	40.0	64/68	110	10	1852.48.48.40	1
Pg 48	40.0	44.0	64/68	110	10	1852.48.48.44	1





Die elektromagnetische Verträglichkeit (EMV) im industriellen Umfeld besitzt einen besonderen Stellenwert, da gerade komplexe Maschinen und Anlagen äusserst anfällig für elektromagnetische Störungen sind. Den unerwünschten EMV-Effekten lässt sich jedoch mit einer wirkungsvollen Schirmung aller Komponenten entgegensteuern. Eine gute Schirmung reduziert einerseits die Störaussendung eines elektrischen Betriebsmittels und verringert gleichzeitig dessen Anfälligkeit für elektromagnetische Beeinträchtigungen.

Allerdings müssen nicht nur die Kabel selbst, sondern auch die restlichen Installationskomponenten einen Schirmcharakter aufweisen. Kabelverschraubungen als passive Bauteile müssen sicherstellen, dass die Qualität der Schirmung an den sensiblen Verbindungsstellen erhalten bleibt und es keine Schirmungsverluste gibt. Insofern ist es notwendig, nicht nur eine maximal geschirmte Leitung zu verwenden, sondern auch EMV-gerechte Kabelverschraubungen einzusetzen. Obwohl für diese Bauteile keine eigenständige EMV-Norm existiert, tragen sie wesentlich dazu bei, dass die vorgeschriebenen EMV-Auflagen der Hersteller erfüllt werden können.

Mit vier unterschiedlichen, EMV-gerechten Kabelverschraubungen bieten wir dem Kunden das passende Produkt und die ideale Kontaktierungsvariante für jeden Anwendungsfall. Bei der Kabelverschraubung Progress® EMV easyCONNECT und neu auch easyCONNECT Multi Messing erfolgt die Kontaktierung über eine innovative Federklammer.

Alle Produktreihen zeichnen sich durch eine leichte Montage aus. Das renommierte Schweizer EMV-Labor MONTENA EMC SA bescheinigt den AGRO Kabelverschraubungen ausserdem eine niedrige Transferimpedanz und hohe Strombelastbarkeit. Beides sind gängige Gütekriterien für die Qualität einer Schirmung. Um hier Bestwerte zu erzielen, bezieht AGRO den EMV-Spezialisten bei der Entwicklung neuer Produkte schon von Beginn an ein.

The electromagnetic compatibility (EMC) in the industrial sector plays a key role because complex machines and systems are extremely susceptible to electromagnetic interference. Such undesired EMC effects, however, can be counteracted with the effective shielding of all components. On the one hand, good shielding reduces the amount of interference emitted by an electrical apparatus while at the same time reducing its susceptibility to impaired performance due to electromagnetic effects.

Not only cables themselves but also all other components that are part of the installation must provide shielding characteristics. As passive components, cable glands must ensure that the quality of the shielding at sensitive interconnection points remains intact and that there are no losses due to the shielding. For this reason, it's necessary to not only use a maximally shielded cable but also add EMC-compliant cable glands. Although there is no separate EMC standard for these components, they play a large contribution towards making it possible to meet the EMC characteristics prescribed by manufacturers.

With four different EMC-compatible cable glands, AGRO offers its customers the appropriate product and the ideal types of contact for each type of application. With the Progress® EMC easyCONNECT and new easyCONNECT Multi brass cable gland, contact is established through an innovative spring clip.

All these product lines stand out due to their easy assembly. Furthermore, the renowned Swiss EMC laboratory MONTENA EMC SA has certified AGRO cable glands for lowest transfer impedance and high current carrying capacity. Both are established criteria for the quality of shielding. In order to achieve a top grade, AGRO involves EMC specialists from the very beginning of new-product development.



<p>Kabelverschraubungen Progress® EMV easyCONNECT Messing mit Kontaktfeder Cable glands Progress® EMC easyCONNECT nickel-plated brass with contact spring Kabelverschraubungen Progress® EMV easyCONNECT Multi Messing für mehrere Kabel Cable glands Progress® EMC easyCONNECT nickel-plated brass for several cables</p>		<p>89</p>	<p>1</p>
<p>Kabelverschraubungen Progress® EMV Rapid Messing mit Kontaktscheibe Cable glands Progress® EMC Rapid nickel-plated brass with contact disc</p>		<p>90 - 91</p>	<p>2</p>
<p>Kabelverschraubungen Progress® EMV Messing mit Kontakthülse Cable glands Progress® EMC nickel-plated brass with contact sleeve</p>		<p>92 - 95</p>	<p>3</p>
<p>Kabelverschraubungen Progress® EMV Messing mit Kontakthülse für hohe Temperaturen Cable glands Progress® EMC nickel-plated brass with contact sleeve for high temperature applications</p>		<p>96 - 97</p>	<p>4</p>
<p>Kabelverschraubungen Progress® EMV Messing mit Knickschutzfeder Cable glands Progress® EMC nickel-plated brass with antikink spring</p>		<p>98 - 99</p>	<p>5</p>
<p>Kabelverschraubungen Progress® EMV Serie 85 Messing mit Spannzange Cable glands Progress® EMC Series 85 nickel-plated brass with collet chuck</p>		<p>100 - 101</p>	<p>6</p>
<p>Zubehör zu EMV-Kabelverschraubungen EMC cable glands accessories</p>		<p>102 - 103</p>	<p>7</p>

8

9

10

11

12

Vier unterschiedliche Kontaktierungsvarianten Four different types of contact

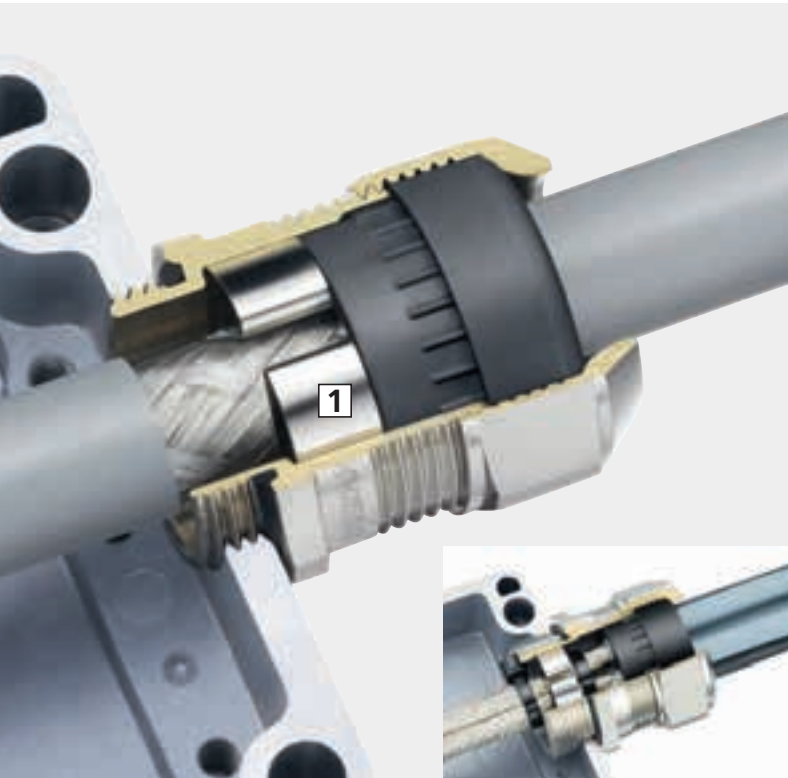

Progress® EMV easyCONNECT Messing

Die Kabelverschraubung Progress® EMV easyCONNECT gewährleistet volle Installationskontrolle und gleicht Toleranzen in den Schirmdicken für einen sicheren Schirmabgriff aus. Das Federsystem ermöglicht eine gute und sichere Schirmkontaktierung sowohl bei partiell abisolierten Abschirmkabeln als auch bei vollständig freigelegten Kabelschirmen.

Die Progress® EMV easyCONNECT Multi ist die erste Kabelverschraubung, die das Einführen von mehreren geschirmten Kabeln in ein Gehäuse erlaubt - und dies mit kraftvollem und sicherem Schirmabgriff

1 Optimale Schirmkontaktierung

Die kraftvolle, schonende Klemmung des Kabelschirms garantiert einen hervorragenden Schirmkontakt und sorgt für extrem niedrige Transferimpedanzen. Durch die spezielle Formgebung der Kontaktfeder ist nicht nur ein grosser Schirmklemmbereich sondern auch die Demontierbarkeit der Kabelverschraubung ohne Zerstörung des EMV-Geflechtes gegeben.

Progress® EMC easyCONNECT nickel-plated brass

The cable glands Progress® EMC easyCONNECT guarantees full control during installation and compensates for tolerances in shielding thicknesses to make a secure screened tap connection. The spring system provides for a very good contact of partially stripped shielding cables equally as well as for the contact of completely exposed cable shields which can be routed further.

The Progress® EMC easyCONNECT Multi is the first cable gland that allows for the entry of several shielded cables into a housing - at any moment granting a strong and safe tap connection.

1 Optimal shield contact

The powerful, protective clamping of the cable shield guarantees excellent shield contact and provides for the smallest possible transfer impedance. The shape of the contact spring not only allows for a large clamping range to the shield but also for easy disassembly without damaging the EMC braid.

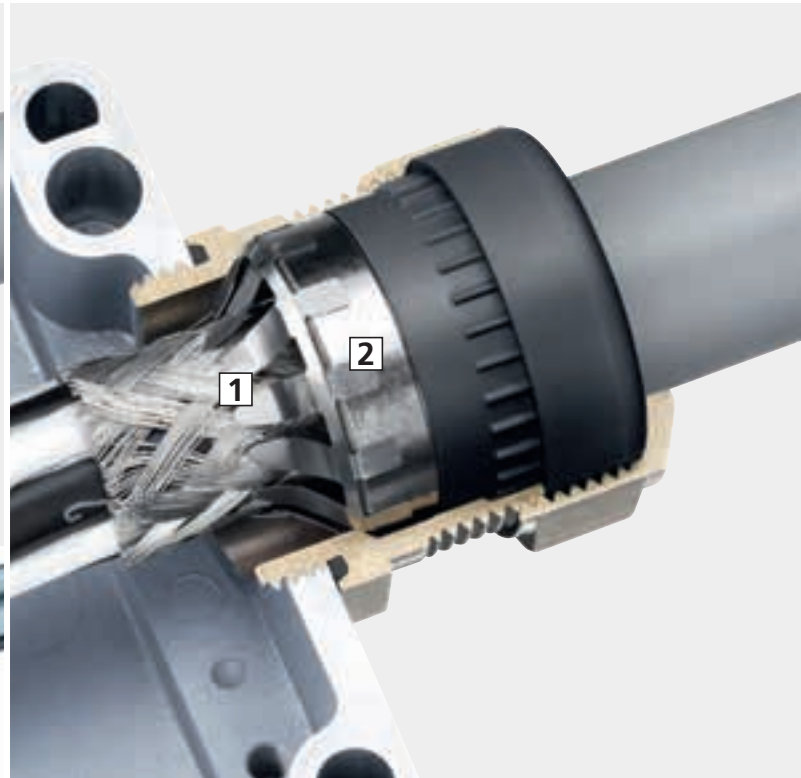

Progress® EMV Rapid Messing

Die Kabelverschraubung mit den zwei Kontaktierungsvarianten für eine sehr schnelle und einfache Schirmkontaktierung durch eine integrierte Kontaktscheibe. Sie ermöglicht die gute Kontaktierung sowohl von partiell abisolierten Abschirmkabeln als auch von vollständig freigelegten Kabelschirmen, die auch weitergeführt werden können.

1 Niedriger Übergangswiderstand

Die grossflächigen, flexiblen Zungen der Kontaktscheibe maximieren die Abgriffsfläche am Schirmgeflecht und erlauben eine zeitsparende Montage.

2 Flexible Kontaktierungsmöglichkeiten

Für eine höherwertige 360° Schirmkontaktierung, kann die Kontaktscheibe ausgestossen werden und das zugeschnittene Schirmgeflecht über die Kontakthülse direkt mit der Kontaktfläche im Unterteil der Kabelverschraubung kontaktiert werden.

Progress® EMC Rapid nickel-plated brass

The cable gland with two contact options. An integrated contact disc allows for easy and fast contact to the shield of partially stripped cables as well as of fully stripped cables which shields are being extended.

1 Low contact resistance

The flexible tongues on the contact disc, with their large surface area, maximise the gripping surface on the braided shield.

2 Flexible terminating methods

If a 360° contact is required, the contact disc can be extruded and the trimmed shield can be connected to the contact bushing. The interlocking "sealing insert/contact sleeve" combination ensures that the contact washer continually presses on the bottom part.

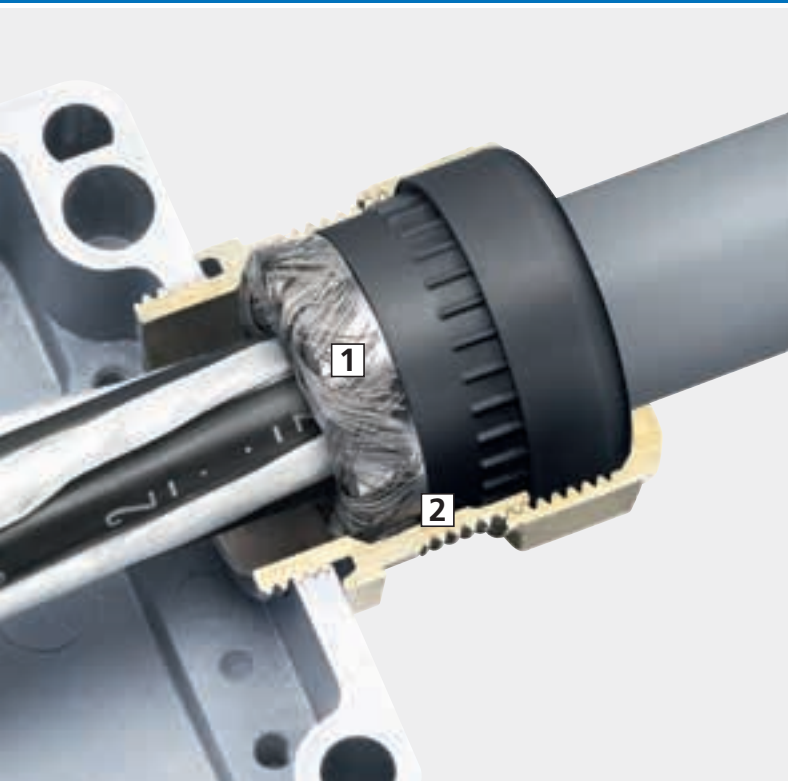

Progress® EMV Messing

Kabelverschraubungen Progress® EMV aus Messing mit der bewährten Kontakthülse ermöglichen eine Schirmkontaktierung von 360° bei in der Kabelverschraubung endendem Schirmgeflecht. Die massgebende Kantengeometrie der Kontakthülse verhindert hierbei ein Abscheren des Schirmgeflechts.

1 Kleinste Übergangswiderstände

Der konzentrische Schirmabgriff von 360° bürgt für kleinste Übergangswiderstände.

2 Permanenter Kontaktdruck

Die ineinandergreifende Kombination „Dichteinsatz-Kontakthülse“ garantiert einen permanenten Kontaktdruck des Schirmgeflechts am Unterteil.

Progress® EMC nickel-plated brass

Progress® EMC cable glands made of brass and with the time-proven contact sleeve make 360° contact with braided shield which terminates at the cable gland. The decisive edge geometry of the contact sleeve prevents any shearing of the braided shield.

1 Low contact resistance

The immense 360° contact surface ensures low contact resistance.

2 Permanent contact pressure

The interlocking "sealing insert/contact sleeve" combination ensures permanent contact pressure of the braided shield against the lower part.

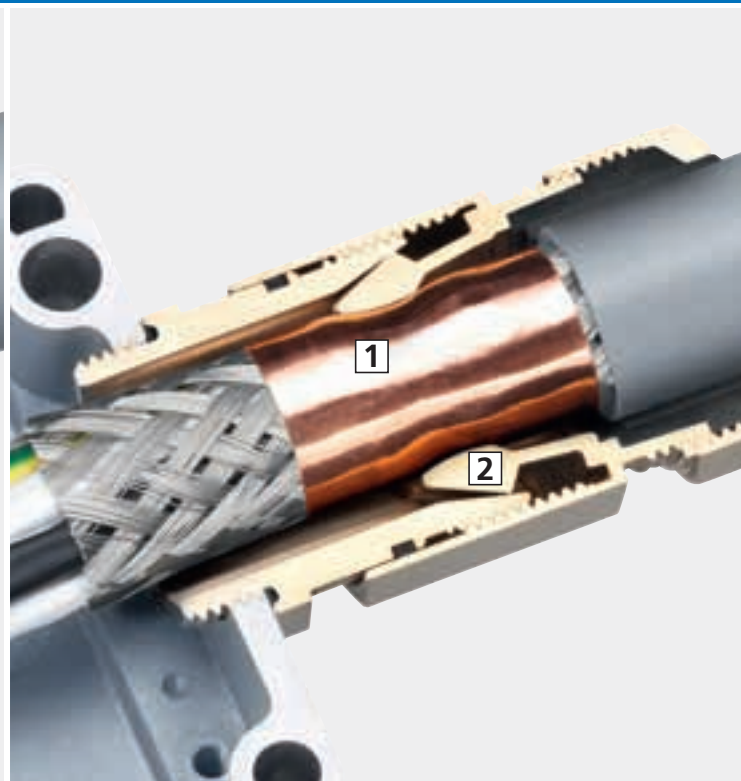

Progress® EMV Serie 85 Messing

Kabelverschraubungen Progress® EMV Serie 85 aus Messing sorgen für eine besonders niederimpedante Verbindung zwischen Schirmgeflecht und Metallgehäuse bei gleichzeitig sicherer Kabelführung.

1 Optimale Schirmkontaktierung

Das Zwischenstück mit den grossen Schlüsselflächen ermöglicht eine einwandfreie Kontaktierung des Schirmgeflechtes durch die wegverstärkenden Spannzangensegmente über 360°. Das Kupferband sorgt für eine gleichmässige Kraftverteilung des Schirmgeflechtes.

2 Höchste Ableitströme

Die massive Spannzange gewährleistet einen konzentrischen, niederimpedanten Schirmabgriff und bewältigt dauerhaft Ableitströme bis 1.6 kA – kurzzeitig 3 kA.

Progress® EMC Series 85 nickel-plated brass

Cable glands Progress® EMC Series 85 made of brass provide an especially low-impedance connection between the braided shield and the metal cabinet as well as safe cable entry.

1 Optimal shield contact

The connector piece, which is secured with the help of large wrenching surfaces, enables perfect contact of the braided shield by means of a collet chuck with segments that slide together around 360°. The copper tap grants equal transmission of the compression power.

2 Highest leakage currents

The massive collet guarantees a concentric, low-impedance screened tap connection and handles leakage currents of up to 1.6 kA continuous – and short term to 3 kA.



	Progress® Messing EMC nickel-plated brass	EMV easyCONNECT EMC easyCONNECT	EMV easyCONNECT Multi EMC easyCONNECT Multi	EMV Rapid EMC Rapid	EMV Standard EMC Standard	EMV Serie 85 EMC Series 85	EMV mit Knickschutzfeder EMC with anti-kink spring	EMV für Hochtemperatur EMC for high temperatures	EMV Zubehör EMC Accessories	EMV Gegenmutter mit Schneidzähnen EMC locknut with cutting teeth	Erdungsflaschen Grounding strap
Ausführung / Version											
Kompressionstechnik Compression technology		•	•	•	•	•	•	•		-	-
EMV Technik / EMC tapping bonding technology											
Kontaktfeder Contact spring		•	•	-	-	-	A	A		-	-
Kontaktscheibe Contact disc		-	-	•	-	-	A	A		-	-
Kontakthülse Contact sleeve		-	-	•	•	-	•	•		-	-
Spannzange Collet chuck		-	-	-	-	•	-	A		-	-
Gewinde / Thread											
Anschlussgewinde metrisch Entry thread metric		•	•	•	•	•	•	•		•	•
Anschlussgewinde Pg Entry thread Pg		A	A	•	•	•	•	•		•	•
Kurzes Anschlussgewinde (Standard) Short entry thread (standard)		•	•	•	•	•	•	•		-	-
Langes Anschlussgewinde Long entry thread		•	•	•	•	A	A	•		-	-
Dichteinsatz / Sealing ring											
für Rundkabel for round cables		•	•	•	•	•	•	•		-	-
einteiliger Dichteinsatz One-piece sealing insert		A	A	•	•	A	•	•		-	-
zweiteiliger Dichteinsatz Two-piece sealing insert		•	-	-	-	•	-	-		-	-
TPE-Dichteinsatz (Standard) standard sealing insert (TPE)		•	•	•	•	•	•	-		-	-
FPM-Dichteinsatz FPM sealing insert		A	A	A	•	A	A	•		-	-
Dichteinsatz nach EN 45545 Sealing insert according to EN 45545		•	•	•	•	•	•	-		-	-
Anwendung / Characteristics											
Knickschutz Anti-kink protection		-	-	-	-	-	•	-		-	-
Schirmgeflecht wird weitergeführt Continuation of braided shield		•	•	•	-	•	-	-		-	-
Schirmgeflecht wird nicht weitergeführt Without continuation of braided shield		•	•	•	•	•	•	•		-	-
variabler Schirm-Klemmbereich Extent of clamping range for the shield		+++	+++	++	+	+	+	+		-	-
niedrige Transferimpedanz Minimal transfer impedance		++	++	+	++	+++	++	++		-	-
hohe Ableitströme (1.6 kA - 3 kA) High leakage currents		-	-	-	-	+++	-	-		-	-
Demontierbarkeit ohne Beschädigung des Kabelschirms Can be dismantled without damaging the shield		+++	+++	-	+	++	-	-		-	-
Installationsfreundlichkeit (kleiner Zeitaufwand) Easy installation (quick assembly)		++	++	+++	+	+	+	+		-	-

• trifft zu / lieferbar applicable / available - trifft nicht zu / nicht lieferbar not applicable / not available +++ hervorragend geeignet very well suited ++ sehr gut geeignet well suited + gut geeignet suited A auf Anfrage upon request

Kabelverschraubungen Progress® EMV easyCONNECT Messing mit Kontaktfeder

Cable glands Progress® EMC easyCONNECT nickel-plated brass with contact spring

Kurzes Anschlussgewinde metrisch | Short entry thread metric

Material: Messing vernickelt
 Kontaktfeder: Federstahl 1.4310
 Dichtung: TPE
 O-Ring : NBR
 Zugentlastung: Ausführung A
 Einsatztemperatur: -60°C / +100°C
 Schutzart: IP 68 (bis 10 bar)
 Weitere Schutzart: IP 69K
 Eigenschaften: Für zeitsparende und sichere Montage von partiell abisolierten sowie durchgehend geschirmten Kabeln

Material: Nickel-plated brass
 Contact spring: Spring steel 1.4310
 Seal: TPE
 O-ring : NBR
 Strain relief: Version A
 Temperature range: -60°C / +100°C
 Protection class: IP 68 (up to 10 bar)
 Further protection: IP 69K
 Properties: For a quick and safe installation of partially dismantled cables as well as thoroughly shielded cables

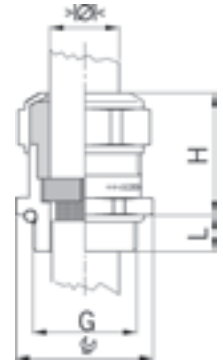

Progress MS EMV easyCONNECT



Zweiteiliger Dichteinsatz
 nicht durchgehend isolierend

Two-piece sealing insert
 not overall length insulated

G	> Ø < min mm	> Ø < max mm	IC	H mm	L mm	i info	Art.-Nr. Art. No.	
M12x1.5	3.5	5.0	15	22	5	1	1083.12.050	50
M12x1.5	5.0	6.5	15	22	5	1	1083.12.065	50
M16x1.5	6.0	10.5	18	25	5	-	1083.17	50
M20x1.5	8.0	15.0	24	27	6	-	1083.20	50
M25x1.5	12.5	20.5	30	33	7	-	1083.25	25
M32x1.5	17.0	25.5	36	33	8	-	1083.32	25

1 = Einteiliger Dichteinsatz

1 = One-piece sealing insert

Erhältlich mit Dichteinsatz gemäss EN 45545. Bei Anfragen oder Bestellung bitte ein F vor die Artikelnummer setzen.

Available with sealing inserts conformity with EN 45545. When placing an inquiry, prefix the article number by the capital F.



Langes Anschlussgewinde metrisch | Long entry thread metric

Progress MS EMV easyCONNECT



Zweiteiliger Dichteinsatz
 nicht durchgehend isolierend

Two-piece sealing insert
 not overall length insulated

G	> Ø < min mm	> Ø < max mm	IC	H mm	L mm	i info	Art.-Nr. Art. No.	
M12x1.5	3.5	5.0	15	22	10	1	1183.12.050	50
M12x1.5	5.0	6.5	15	22	10	1	1183.12.065	50
M16x1.5	6.0	10.5	18	25	10	-	1183.17	50
M20x1.5	8.0	15.0	24	27	10	-	1183.20	50
M25x1.5	12.5	20.5	30	33	11	-	1183.25	25
M32x1.5	17.0	25.5	36	33	13	-	1183.32	25

1 = Einteiliger Dichteinsatz

1 = One-piece sealing insert

Erhältlich mit Dichteinsatz gemäss EN 45545. Bei Anfragen oder Bestellung bitte ein F vor die Artikelnummer setzen.

Available with sealing inserts conformity with EN 45545. When placing an inquiry, prefix the article number by the capital F.



Kabelverschraubungen Progress® EMV easyCONNECT Multi

Cable glands Progress® EMC easyCONNECT Multi



Mit Standard Bohrungen | With standard drills

Mit kundenspezifischen Bohrungen | With customised drills



Sie definieren Anzahl und Durchmesser der Kabeleinführungen - wir liefern Ihnen Ihre individuelle EMV Multi Kabelverschraubung.

AGRO macht kundenspezifische Lösungen möglich.

You define number and diameter of the cable gland - we produce your individual EMC multi cable gland.

AGRO realises customised solutions.

Kabelverschraubungen Progress® EMV Rapid Messing mit Kontaktscheibe

Cable glands Progress® EMC Rapid nickel-plated brass with contact disc

Kurzes Anschlussgewinde metrisch | Short entry thread metric

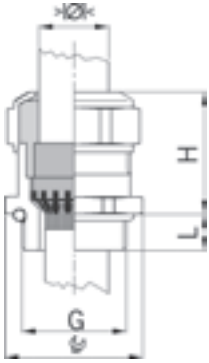

Material: Messing vernickelt
 Kontakthülse: Messing vernickelt
 Kontaktscheibe: Rostfreier Stahl A2
 Dichtung: TPE
 O-Ring : NBR
 Zugentlastung: Ausführung A
 Einsatztemperatur: -40°C / +100°C
 Schutzart: IP 68 (bis 10 bar)
 Weitere Schutzart: IP 69K
 Eigenschaften: Für zeitsparende Montage von partiell abisolierten sowie durchgehend geschirmten Kabeln

Material: Nickel-plated brass
 Contact sleeve: Nickel-plated brass
 Contact disc: Stainless steel A2
 Seal: TPE
 O-ring : NBR
 Strain relief: Version A
 Temperature range: -40°C / +100°C
 Protection class: IP 68 (up to 10 bar)
 Further protection: IP 69K
 Properties: For a quick installation of partially dismantled cables as well as thoroughly shielded cables



Progress MS EMC Rapid

Einteiliger Dichteinsatz
 nicht durchgehend isolierend

One-piece sealing insert
 not overall length insulated

G	> Ø < min mm	> Ø < max mm	IP	H mm	L mm	Art.-Nr. Art. No.	📦
M12x1.5	4.5	6.0	15	20	5	1081.12.060	50
M12x1.5	6.0	7.5	15	20	5	1081.12.075	50
M16x1.5	6.0	8.0	18	23	5	1081.17.080	50
M16x1.5	8.0	10.0	18	25	5	1081.17.100	50
M20x1.5	8.0	11.0	24	25	6	1081.20.110	50
M20x1.5	11.0	14.0	24	27	6	1081.20.140	50
M25x1.5	13.0	16.0	30	30	7	1081.25.160	25
M25x1.5	16.0	19.0	30	33	7	1081.25.190	25
M32x1.5	18.0	21.0	36	32	8	1081.32.210	25
M32x1.5	21.0	25.0	36	32	8	1081.32.250	25

Langes Anschlussgewinde metrisch | Long entry thread metric



Progress MS EMC Rapid

Einteiliger Dichteinsatz
 nicht durchgehend isolierend

One-piece sealing insert
 not overall length insulated

G	> Ø < min mm	> Ø < max mm	IP	H mm	L mm	Art.-Nr. Art. No.	📦
M12x1.5	4.5	6.0	15	20	10	1181.12.060	50
M12x1.5	6.0	7.5	15	20	10	1181.12.075	50
M16x1.5	6.0	8.0	18	23	10	1181.17.080	50
M16x1.5	8.0	10.0	18	25	10	1181.17.100	50
M20x1.5	8.0	11.0	24	25	10	1181.20.110	50
M20x1.5	11.0	14.0	24	27	10	1181.20.140	50
M25x1.5	13.0	16.0	30	30	11	1181.25.160	25
M25x1.5	16.0	19.0	30	33	11	1181.25.190	25
M32x1.5	18.0	21.0	36	32	13	1181.32.210	25
M32x1.5	21.0	25.0	36	32	13	1181.32.250	25

Kabelverschraubungen Progress® EMV Rapid Messing mit Kontaktscheibe

Cable glands Progress® EMC Rapid nickel-plated brass with contact disc

Kurzes Anschlussgewinde Pg | Short entry thread Pg

Material: Messing vernickelt
 Kontakthülse: Messing vernickelt
 Kontaktscheibe: Rostfreier Stahl A2
 Dichtung: TPE
 O-Ring : NBR
 Einsatztemperatur: -40°C / +100°C
 Schutzart: IP 68 (bis 10 bar)
 Weitere Schutzart: IP 69K
 Eigenschaften: Für zeitsparende Montage von partiell abisolierten sowie durchgehend geschirmten Kabeln

Material: Nickel-plated brass
 Contact sleeve: Nickel-plated brass
 Contact disc: Stainless steel A2
 Seal: TPE
 O-ring : NBR
 Temperature range: -40°C / +100°C
 Protection class: IP 68 (up to 10 bar)
 Further protection: IP 69K
 Properties: For a quick installation of partially dismantled cables as well as thoroughly shielded cables

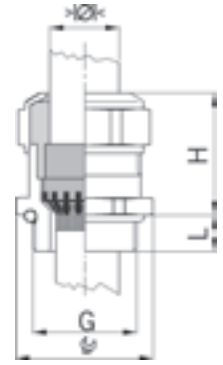

Progress MS EMC Rapid



Einteiliger Dichteinsatz
 nicht durchgehend isolierend

One-piece sealing insert
 not overall length insulated

G	> Ø < min mm	> Ø < max mm		H mm	L mm	Art.-Nr. Art. No.	
Pg 7	4.5	6.0	15	20	6	1081.07.060	50
Pg 7	6.0	7.5	15	20	6	1081.07.075	50
Pg 9	6.0	8.0	18	23	6	1081.09.080	50
Pg 9	8.0	10.0	18	25	6	1081.09.100	50
Pg 11	5.5	8.5	21	25	6	1081.11.085	50
Pg 11	8.5	12.0	21	25	6	1081.11.120	50
Pg 13	8.0	11.0	24	25	6	1081.13.110	50
Pg 13	11.0	14.0	24	27	6	1081.13.140	50
Pg 16	8.0	11.0	24	24	6	1081.16.110	50
Pg 16	11.0	14.0	24	27	6	1081.16.140	50
Pg 21	13.0	16.0	30	30	7	1081.21.160	25
Pg 21	16.0	19.0	30	33	7	1081.21.190	25
Pg 29	19.0	23.0	38	33	8	1081.29.230	25
Pg 29	23.0	25.5	38	32	8	1081.29.255	25



Langes Anschlussgewinde Pg | Long entry thread Pg

Progress MS EMC Rapid



Einteiliger Dichteinsatz
 nicht durchgehend isolierend

One-piece sealing insert
 not overall length insulated

G	> Ø < min mm	> Ø < max mm		H mm	L mm	Art.-Nr. Art. No.	
Pg 7	4.5	6.0	15	20	10	1181.07.060	50
Pg 7	6.0	7.5	15	20	10	1181.07.075	50
Pg 9	6.0	8.0	18	23	10	1181.09.080	50
Pg 9	8.0	10.0	18	25	10	1181.09.100	50
Pg 11	5.5	8.5	21	25	10	1181.11.085	50
Pg 11	8.5	12.0	21	25	10	1181.11.120	50
Pg 13	8.0	11.0	24	25	10	1181.13.110	50
Pg 13	11.0	14.0	24	27	10	1181.13.140	50
Pg 16	8.0	11.0	24	24	10	1181.16.110	50
Pg 16	11.0	14.0	24	27	10	1181.16.140	50
Pg 21	13.0	16.0	30	30	12	1181.21.160	25
Pg 21	16.0	19.0	30	33	12	1181.21.190	25
Pg 29	19.0	23.0	38	33	12	1181.29.230	25
Pg 29	23.0	25.5	38	32	12	1181.29.255	25



Kabelverschraubungen Progress® EMV Messing mit Kontakthülse

Cable glands Progress® EMC nickel-plated brass with contact sleeve

Kurzes Anschlussgewinde metrisch | Short entry thread metric

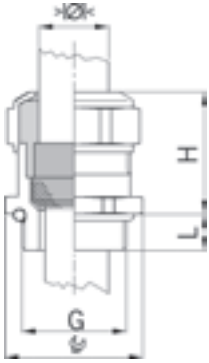

Material:	Messing vernickelt	Material:	Nickel-plated brass
Kontakthülse:	Messing vernickelt	Contact sleeve:	Nickel-plated brass
Dichtung:	TPE	Seal:	TPE
O-Ring :	NBR	O-ring :	NBR
Zugentlastung:	Ausführung A	Strain relief:	Version A
Einsatztemperatur:	-40°C / +100°C	Temperature range:	-40°C / +100°C
Schutzart:	IP 68 (bis 10 bar)	Protection class:	IP 68 (up to 10 bar)
Weitere Schutzart:	IP 69K	Further protection:	IP 69K
Eigenschaften:	Sehr guter Schirmkontakt über die Kontakthülse bei in der Kabelverschraubung endendem Schirmgeflecht	Properties:	Excellent shield contact through the contact sleeve with the braided shield terminating in the screwed cable gland



Progress MS EMC



Einteiliger Dichteinsatz
nicht durchgehend isolierend

One-piece sealing insert
not overall length insulated

G	> Ø < min mm	> Ø < max mm		H mm	L mm	i info	Art.-Nr. Art. No.	
M8x1.25	2.5	3.5	11	15	5	1	1080.08.035	50
M8x1.25	3.0	4.0	11	15	5	1	1080.08.040	50
M10x1.5	3.0	4.0	13	16	5	1	1080.10.040	50
M10x1.5	4.0	6.0	13	16	5	1	1080.10.060	50
M12x1.5	4.5	6.0	15	20	5	-	1080.12.060	50
M12x1.5	6.0	7.5	15	20	5	-	1080.12.075	50
M16x1.5	6.0	8.0	18	23	5	-	1080.17.080	50
M16x1.5	8.0	10.0	18	25	5	-	1080.17.100	50
M20x1.5	8.0	11.0	24	25	6	-	1080.20.110	50
M20x1.5	11.0	14.0	24	27	6	-	1080.20.140	50
M25x1.5	13.0	16.0	30	30	7	-	1080.25.160	25
M25x1.5	16.0	19.0	30	33	7	-	1080.25.190	25
M32x1.5	18.0	21.0	36	32	8	-	1080.32.210	25
M32x1.5	21.0	25.0	36	32	8	-	1080.32.250	25
M40x1.5	24.0	28.5	46	34	8	-	1080.40.285	10
M40x1.5	28.5	32.0	46	34	8	-	1080.40.320	10
M50x1.5	33.0	37.0	55	36	9	-	1080.50.370	10
M50x1.5	37.0	41.0	55	36	9	-	1080.50.410	10
M63x1.5	40.0	46.0	70	39	10	-	1080.63.460	5
M63x1.5	46.0	50.0	70	39	10	-	1080.63.500	5
M75x1.5	50.0	56.0	80	40	11	-	1080.75.560	1
M80x2.0	56.0	65.0	95	45	18	-	1080.80.650	1
M85x2.0	63.0	70.0	95	45	18	-	1080.85.700	1
M95x2.0	68.0	75.0	110	52	20	-	1080.95.750	1

1 = Metrisches Regelgewinde

1 = Metric coarse-pitch thread

Erhältlich mit Dichteinsatz gemäss EN 45545. Bei Anfragen oder Bestellung bitte ein F vor die Artikelnummer setzen.

Available with sealing inserts conformity with EN 45545. When placing an inquiry, prefix the article number by the capital F.

Kabelverschraubungen Progress® EMV Messing mit Kontakthülse

Cable glands Progress® EMC nickel-plated brass with contact sleeve

Langes Anschlussgewinde metrisch | Long entry thread metric

Material: Messing vernickelt
 Kontakthülse: Messing vernickelt
 Dichtung: TPE
 O-Ring : NBR
 Zugentlastung: Ausführung A
 Einsatztemperatur: -40°C / +100°C
 Schutzart: IP 68 (bis 10 bar)
 Weitere Schutzart: IP 69K
 Eigenschaften: Sehr guter Schirmkontakt über die Kontakthülse bei in der Kabelverschraubung endendem Schirmgeflecht

Material: Nickel-plated brass
 Contact sleeve: Nickel-plated brass
 Seal: TPE
 O-ring : NBR
 Strain relief: Version A
 Temperature range: -40°C / +100°C
 Protection class: IP 68 (up to 10 bar)
 Further protection: IP 69K
 Properties: Excellent shield contact through the contact sleeve with the braided shield terminating in the screwed cable gland

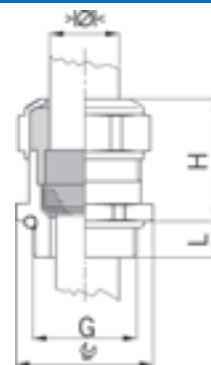

Progress MS EMC



Einteiliger Dichteinsatz
 nicht durchgehend isolierend

One-piece sealing insert
 not overall length insulated

G	> Ø < min mm	> Ø < max mm		H mm	L mm	i info	Art.-Nr. Art. No.	
M8x1.25	2.5	3.5	11	15	10	1	1180.08.035	50
M8x1.25	3.0	4.0	11	15	10	1	1180.08.040	50
M10x1.5	3.0	4.0	13	16	10	1	1180.10.040	50
M10x1.5	4.0	6.0	13	16	10	1	1180.10.060	50
M12x1.5	4.5	6.0	15	20	10	-	1180.12.060	50
M12x1.5	6.0	7.5	15	20	10	-	1180.12.075	50
M16x1.5	6.0	8.0	18	23	10	-	1180.17.080	50
M16x1.5	8.0	10.0	18	25	10	-	1180.17.100	50
M20x1.5	8.0	11.0	24	25	10	-	1180.20.110	50
M20x1.5	11.0	14.0	24	27	10	-	1180.20.140	50
M25x1.5	13.0	16.0	30	30	11	-	1180.25.160	25
M25x1.5	16.0	19.0	30	33	11	-	1180.25.190	25
M32x1.5	18.0	21.0	36	32	13	-	1180.32.210	25
M32x1.5	21.0	25.0	36	32	13	-	1180.32.250	25
M40x1.5	24.0	28.5	46	34	13	-	1180.40.285	10
M40x1.5	28.5	32.0	46	34	13	-	1180.40.320	10
M50x1.5	33.0	37.0	55	36	14	-	1180.50.370	10
M50x1.5	37.0	41.0	55	36	14	-	1180.50.410	10
M63x1.5	40.0	46.0	70	39	14	-	1180.63.460	5
M63x1.5	46.0	50.0	70	39	14	-	1180.63.500	5

1 = Metrisches Regelgewinde

1 = Metric coarse-pitch thread

Erhältlich mit Dichteinsatz gemäss EN 45545. Bei Anfragen oder Bestellung bitte ein F vor die Artikelnummer setzen.

Available with sealing inserts conformity with EN 45545. When placing an inquiry, prefix the article number by the capital F.



Kabelverschraubungen Progress® EMV Messing mit Kontakthülse

Cable glands Progress® EMC nickel-plated brass with contact sleeve

Kurzes Anschlussgewinde Pg | Short entry thread Pg

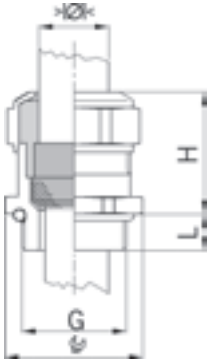

Material: Messing vernickelt
 Kontakthülse: Messing vernickelt
 Dichtung: TPE
 O-Ring : NBR
 Einsatztemperatur: -40°C / +100°C
 Schutzart: IP 68 (bis 10 bar)
 Weitere Schutzart: IP 69K
 Eigenschaften: Sehr guter Schirmkontakt über die Kontakthülse bei in der Kabelverschraubung endendem Schirmgeflecht

Material: Nickel-plated brass
 Contact sleeve: Nickel-plated brass
 Seal: TPE
 O-ring : NBR
 Temperature range: -40°C / +100°C
 Protection class: IP 68 (up to 10 bar)
 Further protection: IP 69K
 Properties: Excellent shield contact through the contact sleeve with the braided shield terminating in the screwed cable gland



Progress MS EMC



Einteiliger Dichteinsatz
 nicht durchgehend isolierend

One-piece sealing insert
 not overall length insulated

G	> Ø < min mm	> Ø < max mm		H mm	L mm	Art.-Nr. Art. No.	
Pg 7	4.5	6.0	15	20	6	1080.07.060	50
Pg 7	6.0	7.5	15	20	6	1080.07.075	50
Pg 9	6.0	8.0	18	23	6	1080.09.080	50
Pg 9	8.0	10.0	18	25	6	1080.09.100	50
Pg 11	5.5	8.5	21	23	6	1080.11.085	50
Pg 11	8.5	12.0	21	23	6	1080.11.120	50
Pg 13	8.0	11.0	24	25	6	1080.13.110	50
Pg 13	11.0	14.0	24	27	6	1080.13.140	50
Pg 16	8.0	11.0	24	24	6	1080.16.110	50
Pg 16	11.0	14.0	24	27	6	1080.16.140	50
Pg 21	13.0	16.0	30	30	7.5	1080.21.160	25
Pg 21	16.0	19.0	30	33	7.5	1080.21.190	25
Pg 29	19.0	23.0	38	33	8	1080.29.230	25
Pg 29	23.0	25.5	38	32	8	1080.29.255	25
Pg 36	25.0	30.5	50	36	8	1080.36.305	10
Pg 36	30.5	35.0	50	34	8	1080.36.350	10
Pg 42	33.0	37.0	55	37	10	1080.42.370	10
Pg 42	37.0	41.0	55	36	10	1080.42.410	10
Pg 48	39.0	43.0	65	42	11	1080.48.430	10
Pg 48	43.0	46.5	65	40	11	1080.48.465	10

Erhältlich mit Dichteinsatz gemäss EN 45545. Bei Anfragen oder Bestellung bitte ein F vor die Artikelnummer setzen.

Available with sealing inserts conformity with EN 45545. When placing an inquiry, prefix the article number by the capital F.

Kabelverschraubungen Progress® EMV Messing mit Kontakthülse

Cable glands Progress® EMC nickel-plated brass with contact sleeve

Langes Anschlussgewinde Pg | Long entry thread Pg

Material: Messing vernickelt
 Kontakthülse: Messing vernickelt
 Dichtung: TPE
 O-Ring : NBR
 Einsatztemperatur: -40°C / +100°C
 Schutzart: IP 68 (bis 10 bar)
 Weitere Schutzart: IP 69K
 Eigenschaften: Sehr guter Schirmkontakt über die Kontakthülse bei in der Kabelverschraubung endendem Schirmgeflecht

Material: Nickel-plated brass
 Contact sleeve: Nickel-plated brass
 Seal: TPE
 O-ring : NBR
 Temperature range: -40°C / +100°C
 Protection class: IP 68 (up to 10 bar)
 Further protection: IP 69K
 Properties: Excellent shield contact through the contact sleeve with the braided shield terminating in the screwed cable gland

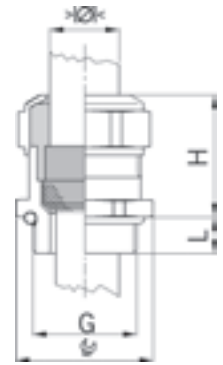

Progress MS EMC



Einteiliger Dichteinsatz
 nicht durchgehend isolierend

One-piece sealing insert
 not overall length insulated

G	>Ø< min mm	>Ø< max mm		H mm	L mm	Art.-Nr. Art. No.	
Pg 7	4.5	6.0	15	20	10	1180.07.060	50
Pg 7	6.0	7.5	15	20	10	1180.07.075	50
Pg 9	6.0	8.0	18	23	10	1180.09.080	50
Pg 9	8.0	10.0	18	25	10	1180.09.100	50
Pg 11	5.5	8.5	21	23	10	1180.11.085	50
Pg 11	8.5	12.0	21	23	10	1180.11.120	50
Pg 13	8.0	11.0	24	25	10	1180.13.110	50
Pg 13	11.0	14.0	24	27	10	1180.13.140	50
Pg 16	8.0	11.0	24	24	10	1180.16.110	50
Pg 16	11.0	14.0	24	27	10	1180.16.140	50
Pg 21	13.0	16.0	30	30	12	1180.21.160	25
Pg 21	16.0	19.0	30	33	12	1180.21.190	25
Pg 29	19.0	23.0	38	33	12	1180.29.230	25
Pg 29	23.0	25.5	38	32	12	1180.29.255	25
Pg 36	25.0	30.5	50	36	15	1180.36.305	10
Pg 36	30.5	35.0	50	34	15	1180.36.350	10
Pg 42	33.0	37.0	55	37	15	1180.42.370	10
Pg 42	37.0	41.0	55	36	15	1180.42.410	10
Pg 48	39.0	43.0	65	42	15	1180.48.430	10
Pg 48	43.0	46.5	65	40	15	1180.48.465	10



Erhältlich mit Dichteinsatz gemäss EN 45545. Bei Anfragen oder Bestellung bitte ein F vor die Artikelnummer setzen.

Available with sealing inserts conformity with EN 45545. When placing an inquiry, prefix the article number by the capital F.

Kurzes Anschlussgewinde metrisch | Short entry thread metric

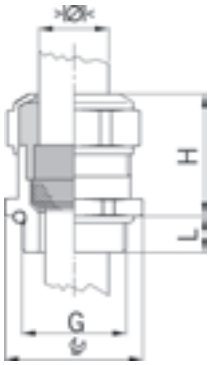

Material:	Messing vernickelt	Material:	Nickel-plated brass
Kontakthülse:	Messing vernickelt	Contact sleeve:	Nickel-plated brass
Dichtung:	FPM	Seal:	FPM
O-Ring :	FPM	O-ring :	FPM
Zugentlastung:	Ausführung A	Strain relief:	Version A
Einsatztemperatur:	-40°C / +200°C	Temperature range:	-40°C / +200°C
Schutzart:	IP 68 (bis 10 bar)	Protection class:	IP 68 (up to 10 bar)
Weitere Schutzart:	IP 69K	Further protection:	IP 69K
Eigenschaften:	Sehr guter Schirmkontakt über die Kontakthülse bei in der Kabelverschraubung endendem Schirmgeflecht	Properties:	Excellent shield contact through the contact sleeve with the braided shield terminating in the screwed cable gland



Einteiliger Dichteinsatz
nicht durchgehend isolierend

One-piece sealing insert
not overall length insulated

G	> Ø < min mm	> Ø < max mm	PG	H mm	L mm	i info	Art.-Nr. Art. No.	
M10x1.5	3.0	4.0	13	16	5	1	1080.10.91.040	50
M10x1.5	4.0	6.0	13	16	5	1	1080.10.91.060	50
M12x1.5	4.5	6.0	15	20	5	-	1080.12.91.060	50
M12x1.5	6.0	7.5	15	20	5	-	1080.12.91.075	50
M16x1.5	6.0	8.0	18	23	5	-	1080.17.91.080	50
M16x1.5	8.0	10.0	18	25	5	-	1080.17.91.100	50
M20x1.5	8.0	11.0	24	25	6	-	1080.20.91.110	50
M20x1.5	11.0	14.0	24	27	6	-	1080.20.91.140	50
M25x1.5	13.0	16.0	30	30	7	-	1080.25.91.160	25
M25x1.5	16.0	19.0	30	33	7	-	1080.25.91.190	25
M32x1.5	18.0	21.0	36	32	8	-	1080.32.91.210	25
M32x1.5	21.0	25.0	36	32	8	-	1080.32.91.250	25

1 = Metrisches Regelgewinde

1 = Metric coarse-pitch thread

Langes Anschlussgewinde metrisch | Long entry thread metric



Einteiliger Dichteinsatz
nicht durchgehend isolierend

One-piece sealing insert
not overall length insulated

G	> Ø < min mm	> Ø < max mm	PG	H mm	L mm	i info	Art.-Nr. Art. No.	
M10x1.5	3.0	4.0	13	16	10	1	1180.10.91.040	50
M10x1.5	4.0	6.0	13	16	10	1	1180.10.91.060	50
M12x1.5	4.5	6.0	15	20	10	-	1180.12.91.060	50
M12x1.5	6.0	7.5	15	20	10	-	1180.12.91.075	50
M16x1.5	6.0	8.0	18	23	10	-	1180.17.91.080	50
M16x1.5	8.0	10.0	18	25	10	-	1180.17.91.100	50
M20x1.5	8.0	11.0	24	25	10	-	1180.20.91.110	50
M20x1.5	11.0	14.0	24	27	10	-	1180.20.91.140	50
M25x1.5	13.0	16.0	30	30	11	-	1180.25.91.160	25
M25x1.5	16.0	19.0	30	33	11	-	1180.25.91.190	25
M32x1.5	18.0	21.0	36	32	13	-	1180.32.91.210	25
M32x1.5	21.0	25.0	36	32	13	-	1180.32.91.250	25

1 = Metrisches Regelgewinde

1 = Metric coarse-pitch thread



Kurzes Anschlussgewinde Pg | Short entry thread Pg

Material: Messing vernickelt
 Kontakthülse: Messing vernickelt
 Dichtung: FPM
 O-Ring : FPM
 Einsatztemperatur: -40°C / +200°C
 Schutzart: IP 68 (bis 10 bar)
 Weitere Schutzart: IP 69K
 Eigenschaften: Sehr guter Schirmkontakt über die Kontakthülse bei in der Kabelverschraubung endendem Schirmgeflecht

Material: Nickel-plated brass
 Contact sleeve: Nickel-plated brass
 Seal: FPM
 O-ring : FPM
 Temperature range: -40°C / +200°C
 Protection class: IP 68 (up to 10 bar)
 Further protection: IP 69K
 Properties: Excellent shield contact through the contact sleeve with the braided shield terminating in the screwed cable gland

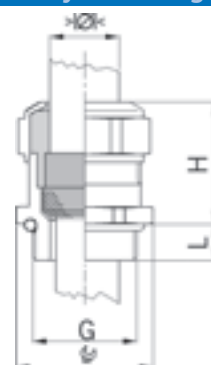

Einteiliger Dichteinsatz
 nicht durchgehend isolierend

One-piece sealing insert
 not overall length insulated

G	> Ø < min mm	> Ø < max mm		H mm	L mm	Art.-Nr. Art. No.	
Pg 9	6.0	8.0	18	23	6	1080.09.91.080	50
Pg 9	8.0	10.0	18	25	6	1080.09.91.100	50
Pg 11	5.5	8.5	21	23	6	1080.11.91.085	50
Pg 11	8.5	12.0	21	23	6	1080.11.91.120	50
Pg 13	8.0	11.0	24	25	6	1080.13.91.110	50
Pg 13	11.0	14.0	24	27	6	1080.13.91.140	50
Pg 16	8.0	11.0	24	24	6	1080.16.91.110	50
Pg 16	11.0	14.0	24	27	6	1080.16.91.140	50
Pg 21	13.0	16.0	30	30	7.5	1080.21.91.160	25
Pg 21	16.0	19.0	30	33	7.5	1080.21.91.190	25
Pg 29	19.0	23.0	38	33	8	1080.29.91.230	25
Pg 29	23.0	25.5	38	32	8	1080.29.91.255	25



Langes Anschlussgewinde Pg | Long entry thread Pg



Einteiliger Dichteinsatz
 nicht durchgehend isolierend

One-piece sealing insert
 not overall length insulated

G	> Ø < min mm	> Ø < max mm		H mm	L mm	Art.-Nr. Art. No.	
Pg 9	6.0	8.0	18	23	10	1180.09.91.080	50
Pg 9	8.0	10.0	18	25	10	1180.09.91.100	50
Pg 11	5.5	8.5	21	23	10	1180.11.91.085	50
Pg 11	8.5	12.0	21	23	10	1180.11.91.120	50
Pg 13	8.0	11.0	24	25	10	1180.13.91.110	50
Pg 13	8.5	12.0	24	27	10	1180.13.91.140	50
Pg 16	8.0	11.0	24	24	10	1180.16.91.110	50
Pg 16	11.0	14.0	24	27	10	1180.16.91.140	50
Pg 21	13.0	16.0	30	30	12	1180.21.91.160	25
Pg 21	16.0	19.0	30	33	12	1180.21.91.190	25
Pg 29	19.0	23.0	38	33	12	1180.29.91.230	25
Pg 29	23.0	25.5	38	32	12	1180.29.91.255	25



Kabelverschraubungen Progress® EMV Messing mit Knickschutzfeder

Cable glands Progress® EMC nickel-plated brass with antikink spring

Kurzes Anschlussgewinde metrisch | Short entry thread metric



Material:	Messing vernickelt	Material:	Nickel-plated brass
Knickschutzfeder:	Rostfreier Stahl A2	Antikink spring:	Stainless steel A2
Dichtung:	TPE	Seal:	TPE
O-Ring :	NBR	O-ring :	NBR
Zugentlastung:	Ausführung A	Strain relief:	Version A
Einsatztemperatur:	-40°C / +100°C	Temperature range:	-40°C / +100°C
Schutzart:	IP 68	Protection class:	IP 68
Weitere Schutzart:	IP 69K	Further protection:	IP 69K
Eigenschaften:	Sehr guter Schirmkontakt über die Kontakthülse bei in der Kabelverschraubung endendem Schirmgeflecht	Properties:	Excellent shield contact through the contact sleeve with the braided shield terminating in the screwed cable gland

Progress MS EMC FKN



Einteiliger Dichteinsatz
nicht durchgehend isolierend

One-piece sealing insert
not overall length insulated

G	> Ø < min mm	> Ø < max mm		H mm	L mm	i info	Art.-Nr. Art. No.	
M8x1.25	2.5	3.5	11	50	5	1	1080.08.52.035	10
M8x1.25	3.0	4.0	11	50	5	1	1080.08.52.040	10
M10x1.5	3.0	4.0	13	54	5	1	1080.10.52.040	10
M10x1.5	4.0	6.0	13	54	5	1	1080.10.52.060	10
M12x1.5	4.5	6.0	15	60	5	-	1080.12.52.060	10
M12x1.5	6.0	7.5	15	60	5	-	1080.12.52.075	10
M16x1.5	6.0	8.0	18	69	5	-	1080.17.52.080	10
M16x1.5	8.0	10.0	18	69	5	-	1080.17.52.100	10
M20x1.5	8.0	11.0	24	88	6	-	1080.20.52.110	10
M20x1.5	11.0	14.0	24	88	6	-	1080.20.52.140	10
M25x1.5	13.0	16.0	30	104	7	-	1080.25.52.160	10
M25x1.5	16.0	19.0	30	104	7	-	1080.25.52.190	10
M32x1.5	18.0	21.0	36	112	8	-	1080.32.52.210	5
M32x1.5	21.0	24.5	36	112	8	-	1080.32.52.245	5

1 = Metrisches Regelgewinde

1 = Metric coarse-pitch thread

Erhältlich mit Dichteinsatz gemäss EN 45545. Bei Anfragen oder Bestellung bitte ein F vor die Artikelnummer setzen.

Available with sealing inserts conformity with EN 45545. When placing an inquiry, prefix the article number by the capital F.

Langes Anschlussgewinde auf Anfrage

Long entry thread available on request

Kabelverschraubungen Progress® EMV Messing mit Knickschutzfeder Cable glands Progress® EMC nickel-plated brass with antikink spring

Kurzes Anschlussgewinde Pg | Short entry thread Pg

Material: Messing vernickelt
Knickschutzfeder: Rostfreier Stahl A2
Dichtung: TPE
O-Ring : NBR
Einsatztemperatur: -40°C / +100°C
Schutzart: IP 68
Eigenschaften: Sehr guter Schirmkontakt über die Kontakthülse bei in der Kabelverschraubung endendem Schirmgeflecht

Material: Nickel-plated brass
Antikink spring: Stainless steel A2
Seal: TPE
O-ring : NBR
Temperature range: -40°C / +100°C
Protection class: IP 68
Properties: Excellent shield contact through the contact sleeve with the braided shield terminating in the screwed cable gland

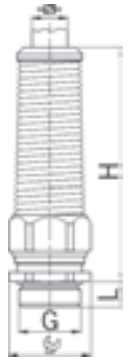

Progress MS EMC FKN



Einteiliger Dichteinsatz
nicht durchgehend isolierend

One-piece sealing insert
not overall length insulated

G	> Ø < min mm	> Ø < max mm		H mm	L mm	Art.-Nr. Art. No.	
Pg 7	4.5	6.0	15	60	6	1080.07.52.060	10
Pg 7	6.0	7.5	15	60	6	1080.07.52.075	10
Pg 9	6.0	8.0	18	69	6	1080.09.52.080	10
Pg 9	8.0	10.0	18	69	6	1080.09.52.100	10
Pg 11	6.0	8.0	18/21	69	6	1080.11.52.080	10
Pg 11	8.0	10.0	18/21	69	6	1080.11.52.100	10
Pg 13	8.0	11.0	24	88	6	1080.13.52.110	10
Pg 13	11.0	14.0	24	88	6	1080.13.52.140	10
Pg 16	8.0	11.0	24	88	6	1080.16.52.110	10
Pg 16	11.0	14.0	24	88	6	1080.16.52.140	10
Pg 21	13.0	16.0	30	104	7	1080.21.52.160	5
Pg 21	16.0	19.0	30	104	7	1080.21.52.190	5

Erhältlich mit Dichteinsatz gemäss EN 45545. Bei Anfragen oder Bestellung bitte ein F vor die Artikelnummer setzen.

Available with sealing inserts conformity with EN 45545. When placing an inquiry, prefix the article number by the capital F.

Langes Anschlussgewinde auf Anfrage

Long entry thread available on request



Kabelverschraubungen Progress® EMV Serie 85 Messing mit Spannzange

Cable glands Progress® EMC Series 85 nickel-plated brass with collet chuck

Anschlussgewinde metrisch | Entry thread metric

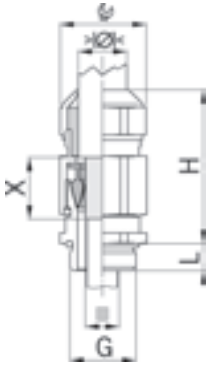

Material: Messing vernickelt
 Dichtung: TPE
 O-Ring : NBR
 Zugentlastung: Ausführung A
 Einsatztemperatur: -40°C / +100°C
 Schutzart: IP 68 (bis 10 bar)
 Weitere Schutzart: IP 69K
 Eigenschaften: Für hohe Ableitströme, konzentrische Schirmkontaktierung mit tiefsten Übergangswiderständen und Transferimpedanzen

Material: Nickel-plated brass
 Seal: TPE
 O-ring : NBR
 Strain relief: Version A
 Temperature range: -40°C / +100°C
 Protection class: IP 68 (up to 10 bar)
 Further protection: IP 69K
 Properties: For high leakage currents, concentric shield contact with minimal transfer resistances and transfer impedances

Progress MS EMV Serie 85



Zweiteiliger Dichteinsatz
 nicht durchgehend isolierend

Two-piece sealing insert
 not overall length insulated

G	>Ø< min mm	>Ø< max mm	>■< mm	IC	H mm	L mm	X mm	Art.-Nr. Art. No.	
M16x1.5	4.5	6.0	3.0-4.5	18	40	6	14	1000.17.85.045	25
M16x1.5	6.0	10.5	4.5-8.0	18	42	8	16	1000.17.85.080	25
M16x1.5	8.0	15.0	7.5-10.0	24	47	8	20	1000.17.85.100	25
M20x1.5	8.0	15.0	7.5-12.0	24	47	8	20	1000.20.85.120	25
M20x1.5	12.5	20.5	10.0-14.0	30	59	8	21	1000.20.85.140	20
M25x1.5	12.5	20.5	10.0-16.0	30	59	8	21	1000.25.85.160	20
M25x1.5	17.0	25.5	14.0-19.0	36	66	8	24	1000.25.85.190	25
M32x1.5	17.0	25.5	14.0-22.0	36	66	10	24	1000.32.85.220	25
M32x1.5	24.0	33.0	21.0-25.0	46	68	10	24	1000.32.85.250	5
M40x1.5	24.0	33.0	21.0-30.0	46	68	12	24	1000.40.85.300	5
M50x1.5	33.0	42.0	29.0-38.0	55	82	13	30	1000.50.85.380	5
M63x1.5	33.0	42.0	29.0-38.0	70/55	82	15	30	1000.63.85.380	5
M63x1.5	40.0	52.0	35.0-44.0	70	78	15	26	1000.63.85.440	1

Erhältlich mit Dichteinsatz gemäss EN 45545. Bei Anfragen oder Bestellung bitte ein F vor die Artikelnummer setzen.

Available with sealing inserts conformity with EN 45545. When placing an inquiry, prefix the article number by the capital F.

Wichtig!

Um den Kabelschirm und die Kabellitzen optimal zu schützen ist es erforderlich, das der Kabelverschraubung beiliegende Kupfer-EMV-Tape zu montieren.

Important!

To provide the best possible protection for the cable shield and the cable, it is necessary to install a copper EMC tape.

Das Kupfer-Tape muss zwingend gemäß Illustration montiert werden! (Beispiel: Tape Scotch 3M Typ 1181)

The copper tape must be fixed according to the illustration! (example: Tape Scotch 3M Typ 1181)



Kabelverschraubungen Progress® EMV Serie 85 Messing mit Spannzange

Cable glands Progress® EMC Series 85 nickel-plated brass with collet chuck

Anschlussgewinde Pg | Entry thread Pg

Material: Messing vernickelt
 Dichtung: TPE
 O-Ring : NBR
 Einsatztemperatur: -40°C / +100°C
 Schutzart: IP 68 (bis 10 bar)
 Weitere Schutzart: IP 69K
 Eigenschaften: Für hohe Ableitströme, konzentrische Schirmkontaktierung mit tiefsten Übergangswiderständen und Transferimpedanzen

Material: Nickel-plated brass
 Seal: TPE
 O-ring : NBR
 Temperature range: -40°C / +100°C
 Protection class: IP 68 (up to 10 bar)
 Further protection: IP 69K
 Properties: For high leakage currents, concentric shield contact with minimal transfer resistances and transfer impedances

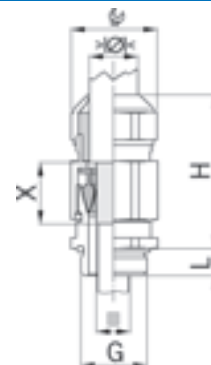

Zweiteiliger Dichteinsatz nicht durchgehend isolierend		Two-piece sealing insert not overall length insulated						Art.-Nr. Art. No.		
G	>Ø< min mm	>Ø< max mm	>■< mm	IC	H mm	L mm	X mm			
Pg 11	6.0	10.5	4.5-8.0	21/18	42	8	16		1000.11.85.080	25
Pg 11	8.0	15.0	7.5-12.0	24	47	8	20		1000.11.85.120	25
Pg 16	8.0	15.0	7.5-12.0	24	47	8	20		1000.16.85.120	25
Pg 16	12.5	20.5	10.0-15.0	30	59	8	21		1000.16.85.150	25
Pg 21	12.5	20.5	10.0-16.0	30	59	8	21		1000.21.85.160	20
Pg 21	17.0	25.5	14.0-19.0	36	66	8	24		1000.21.85.190	25
Pg 29	17.0	25.5	14.0-22.0	38/36	66	10	24		1000.29.85.220	20
Pg 29	24.0	33.0	21.0-25.0	46	68	10	24		1000.29.85.250	5



Erhältlich mit Dichteinsatz gemäss EN 45545. Bei Anfragen oder Bestellung bitte ein F vor die Artikelnummer setzen.

Available with sealing inserts conformity with EN 45545. When placing an inquiry, prefix the article number by the capital F.

Wichtig!

Um den Kabelschirm und die Kabellitzen optimal zu schützen ist es erforderlich, das der Kabelverschraubung beiliegende Kupfer-EMV-Tape zu montieren.

Important!

To provide the best possible protection for the cable shield and the cable, it is necessary to install a copper EMC tape.

Weitere Abmessungen auf Anfrage

Further dimensions upon request

Das Kupfer-Tape muss zwingend gemäß Illustration montiert werden! (Beispiel: Tape Scotch 3M Typ 1181)

The copper tape must be fixed according to the illustration! (example: Tape Scotch 3M Typ 1181)



Zubehör zu EMV-Kabelverschraubungen

EMC cable glands accessories

Anschlussgewinde metrisch | Entry thread metric

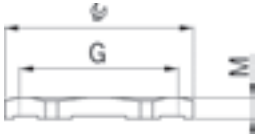

EMV-Gegenmuttern Messing mit Schneidezähnen

Material: Messing vernickelt
 Ausführung: EMV-Gegenmutter Messing mit Schneidezähnen für eine optimale Kontaktierung
 Einsatztemperatur: -60°C / +200°C

EMC lock nuts nickel-plated brass with cutter teeth

Material: Nickel-plated brass
 Execution: EMC lock nut brass with cutting teeth for optimised shield contact
 Temperature range: -60°C / +200°C



G	IC	M mm	i info	Art.-Nr. Art. No.	
M8x1.25	11	3.3	1	8008.85	25
M10x1.5	13	3.3	1	8010.85	25
M12x1.5	15	3.5	-	8012.85	25
M16x1.5	19	3.5	-	8017.85	25
M20x1.5	24	4.0	-	8020.85	25
M25x1.5	30	4.0	-	8025.85	10
M32x1.5	36	5.0	-	8032.85	10
M40x1.5	46	5.3	-	8040.85	10
M50x1.5	55	6.3	-	8050.85	10
M63x1.5	70	7.0	-	8063.85	10

1 = Metrisches Regelgewinde 1 = Metric coarse-pitch thread

Anschlussgewinde Pg | Entry thread Pg



G	IC	M mm	Art.-Nr. Art. No.	
Pg 7	15	3.3	8007.85	25
Pg 9	18	3.3	8009.85	25
Pg 11	21	3.5	8011.85	25
Pg 13	24	3.5	8013.85	25
Pg 16	26	3.5	8016.85	25
Pg 21	32	4.0	8021.85	10
Pg 29	41	4.6	8029.85	10
Pg 36	50	5.8	8036.85	10
Pg 42	60	5.8	8042.85	10
Pg 48	64	6.5	8048.85	10

passend zu Kabelverschraubungen Progress® | suitable for cable glands Progress®

Erdungslaschen zu Kabelverschraubungen | Grounding straps suitable for cable glands

Material: Messing roh
 Einsatztemperatur: -60°C / +200°C
 Einsatzbereich: Löt- oder steckbar
 6,3 x 1,0 mm

Material: Brass raw
 Temperature range: -60°C / +200°C
 Application: Solderable or pluggable
 6,3 x 1,0 mm

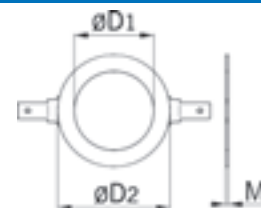

Erdungslaschen zu Kabelverschraubungen Anschlussgewinde metrisch

Grounding straps suitable for cable glands Entry thread metric

G	ØD1 mm	ØD2 mm	M mm	Art.-Nr. Art. No.	
M12 / Pg 7	13.0	24	1	1007.80.10	100
M16	16.5	24	1	1017.80.10	100
M20 / Pg 13	20.7	28	1	1020.80.10	100
M25	25.5	32	1	1025.80.10	100
M32	33.0	40	1	1032.80.10	100
M40	40.5	52	1	1040.80.10	100
M50	50.5	62	1	1050.80.10	50
M63	63.5	78	1	1063.80.10	50



Erdungslaschen zu Kabelverschraubungen Anschlussgewinde Pg

Grounding straps suitable for cable glands Entry thread Pg

G	ØD1 mm	ØD2 mm	M mm	Art.-Nr. Art. No.	
M12 / Pg 7	13.0	24	1	1007.80.10	100
Pg 9	16.0	24	1	1009.80.10	100
Pg 11	19.0	28	1	1011.80.10	100
M20 / Pg 13	20.7	28	1	1020.80.10	100
Pg 16	23.0	32	1	1016.80.10	100
Pg 21	29.0	37	1	1021.80.10	100
Pg 29	38.0	52	1	1029.80.10	50
Pg 36	48.0	62	1	1036.80.10	50



AGRO Kabelverschraubungen Progress® nach EN 45545

AGRO Cable glands Progress® according to EN 45545

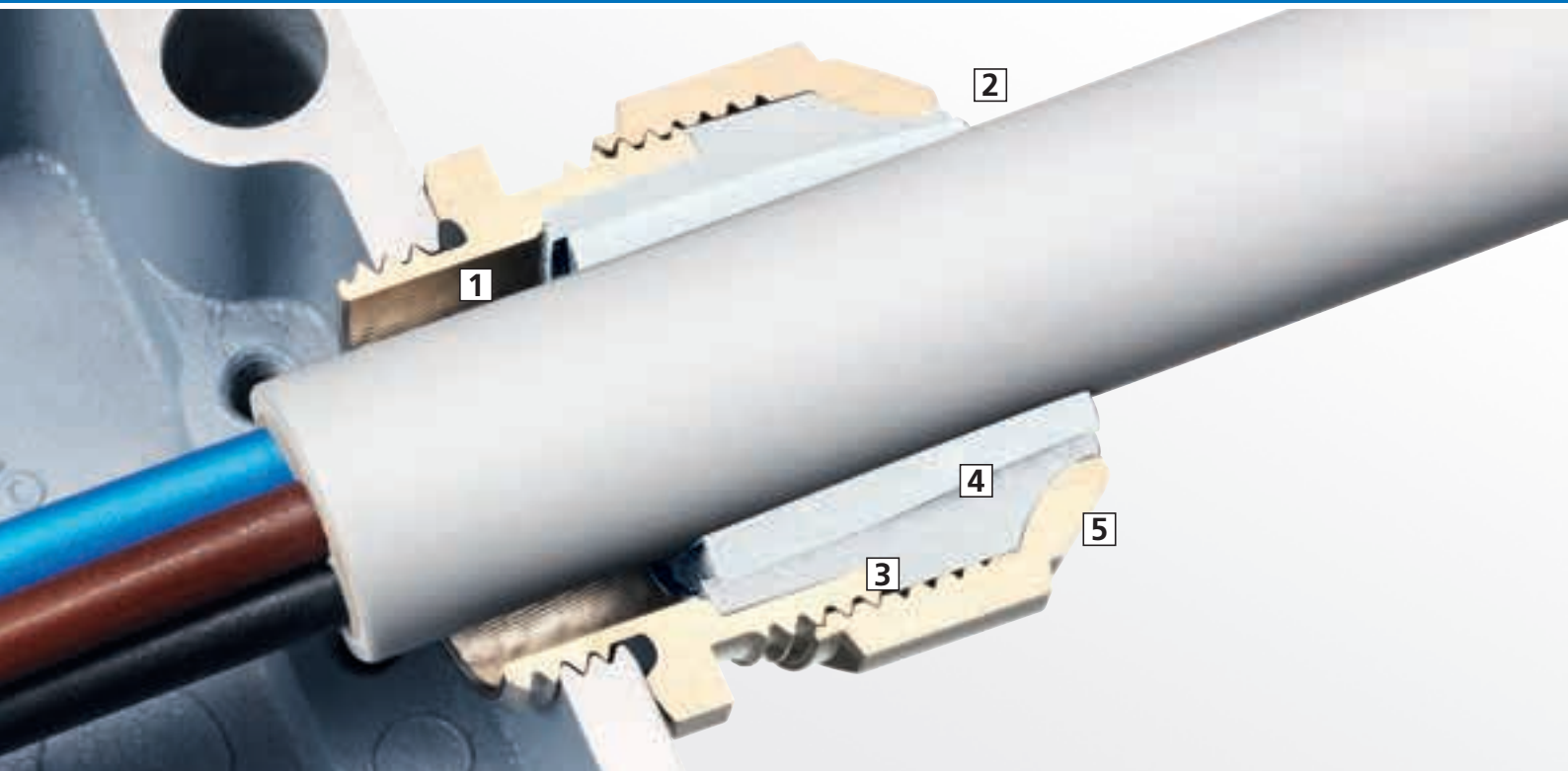

AGRO Kabelverschraubungen Progress® in Metall für den Einsatz in Schienenfahrzeugen

AGRO Progress® Kabelverschraubungen aus Metall können mit Dichteinsätzen aus einem speziellem TPE bestückt werden. In dieser Ausführung sind sie zertifiziert nach EN 45545 und können bedenkenlos für alle Anwendungen und Anordnungen im Schienenfahrzeugbau eingesetzt werden.

1 Kurze, lange oder Spezial-Anschlussgewinde

Kabelverschraubungen Progress® mit kurzem oder langem Anschlussgewinde in metrischer oder Ausführung können bei vorhandenem Öffnungsgewinde oder mit Gegenmutter verwendet werden.

2 Sichtbare Sicherheit

Der kleine Wulst des Dichteinsatzes bestätigt das richtige Anzugsmoment.

3 Hoher Verdrehschutz

Die im Unterteil integrierte Längsrandrierung sorgt über den Dichteinsatz für eine hohe Verdrehsicherheit.

4 Kompressionstechnik

Die ein- oder zweiteiligen Dichteinsätze werden durch die Druckmutter verpresst und eine ausserordentlich Kabel schonende Zugentlastung wird erreicht. Der Kabelmantel bleibt selbst bei dynamischen Anwendungen langfristig intakt.

5 Garantierte Dichtigkeit

Auf den Dichteinsatz abgestimmte Innenkonturen sorgen für eine zielgerichtete Verformung des Dichteinsatzes und garantieren somit dessen perfekte Abdichtung. Die Schutzart IP 68 bis 10 bar sowie IP 69K ermöglichen eine breite Anwendung.

Metal cable glands Progress® for railway applications

AGRO Progress® metal cable glands can be equipped with sealing inserts made of a special TPE. These versions are certified according to EN 45545 and can be used with confidence for any rolling stock application.

1 Short, long or special entry thread

Cable glands Progress® with short or long entry thread designed as metric or Pg can be used with existing opening threads or with a counter nut.

2 Visible safety

The small bead in the sealing insert confirms the correct tightening torque.

3 High distortion protection

The integrated retaining grooves in the lower part and in the sealing insert grant against twisting.

4 Compression technology

The one or two-part sealing inserts are being compressed by a compression nut. A very cable-protecting strain relief is produced. The cable sheath will not be harmed, even on the occasion of long-term dynamic stress.

5 Guaranteed seal

Inner contours matched to the sealing insert ensure a targeted deformation of the insert and thus guarantee its tightness in compliance with protection class IP 68 up to 10 bar and IP 69K for a wide range of applications.



Kabelverschraubungen Progress® Metall nach EN 45545
Cable glands Progress® Metall according to EN 45545



106 - 107

- Progress® Messing
Progress® nickel-plated brass
- Standard
Standard
- EMV Kabelverschraubungen
EMC cable glands
- Kombi-Schlauchverschraubungen
Combination conduit glands
- Winkel
Elbows
- für mehrere Kabel
for installation of multiple cables
- mit Dichteinsatz ohne Bohrung
with sealing insert without drilled hole
- für spezielle Kabel
for special cables
- mit Knickschutzfeder
with antikink spring
- mit Trompete und / oder Klemmbacken
with trumpet and / or clamps

Ausführung / Version	Progress® Messing Progress® nickel-plated brass	Standard Standard	EMV Kabelverschraubungen EMC cable glands	Kombi-Schlauchverschraubungen Combination conduit glands	Winkel Elbows	für mehrere Kabel for installation of multiple cables	mit Dichteinsatz ohne Bohrung with sealing insert without drilled hole	für spezielle Kabel for special cables	mit Knickschutzfeder with antikink spring	mit Trompete und / oder Klemmbacken with trumpet and / or clamps
Kompressionstechnik Compression technology	•	•	•	•	•	•	•	•	•	•
Gewinde / Thread										
Anschlussgewinde metrisch Entry thread metric	•	•	•	•	•	•	•	•	•	•
Anschlussgewinde Pg Entry thread Pg	•	•	•	•	•	•	•	•	•	•
Kurzes Anschlussgewinde (Standard) Short entry thread (standard)	•	•	•	•	•	•	•	•	•	•
Langes Anschlussgewinde Long entry thread	•	•	•	•	•	•	•	•	•	•
Sondergewinde (extra lang, Innengewinde) Special thread (extra long, internal thread)	•	-	-	-	-	-	-	-	-	-
Dichteinsatz / Sealing insert										
für Rundkabel for round cables	•	•	•	•	•	-	-	•	•	•
für Flachkabel for flat cables	•	-	-	-	-	-	•	-	-	-
für mehrere Kabel (Multi-Dichteinsatz) for multi sealing insert	•	•	-	-	•	-	-	-	-	-
Vollgummi-Dichteinsatz Solid rubber sealing insert	•	•	-	-	-	•	-	-	-	-
einteiliger Dichteinsatz One-piece sealing insert	•	•	-	-	•	•	•	•	-	-
zweiteiliger Dichteinsatz Two-piece sealing insert	•	•	•	•	-	-	-	•	•	•
Technische Besonderheiten / Technical features										
Vibrationsschutz Vibration resistance	•	•	•	•	•	•	•	•	•	•
Material / Material										
Messing vernickelt Nickel-plated brass	•	•	•	•	•	•	•	•	•	•
rostfreier Stahl A2 Stainless steel A2	•	-	-	-	•	•	•	-	-	-

1
2
3
4
5
6
7
8
9
10
11
12

AGRO Kabelverschraubungen Progress® nach EN 45545-2

AGRO Cable glands Progress® according to EN 45545-2



Beste Resultate bei Prüfungen nach EN 45545-2 (Komponenten)

Die Dichteinsätze der Progress® Kabelverschraubung sind aus einem speziellen TPE gefertigt und sind im anspruchsvollsten **Hazard Level 3 zertifiziert**.

Die geforderten Werte für Hazard Level 3 wurden sowohl im Außen- als auch im Innenbereich deutlich übertroffen:

Best results in testing according to EN 45545-2 (Components)

The seal inserts of Progress® cable glands are made from a special TPE and certified to the demanding **Hazard Level 3**.

The stipulated values for Hazard Level 3 were exceeded, for both indoor and outdoor areas: **Best results in testing according to EN 45545-2 (Components)**

	Normwert für HL 3 aussen Requirement for HL 3 outdoor	Normwert für HL 3 innen Requirement for HL 3 indoor	AGRO Resultat AGRO resultA
Sauerstoffindex Oxygen index	Min. 32%	Min. 32%	39%
Rauchgasdichte Ds Smoke gas density Ds	Max. 300	Max. 150	110
Toxizität CIT Toxicity CIT	Max. 1.5	Max. 0.75	0.16

Vorgaben der EN 45545-3 übertroffen!

Ziel der **EN 45545-3** ist es, die Brandausbreitung durch Materialanforderungen zu begrenzen. Wenn Kabel durch Feuerschutzabschlüsse geführt werden, gelten diese Anforderungen auch für Kabelverschraubungen.

AGRO Progress® Kabelverschraubungen aus Metall übertreffen die Vorgaben der **EN 45545-3** bei weitem und erreichen die sehr hohe Feuerwiderstandsklasse **E30**. Die Dichteinsätze sind mindestens 30 Minuten lang dicht und verhindern einen Flammenübertrag auf die dem Feuer abgewandte Seite und es bilden sich keine Spalten. Sie können aus brandschutztechnischer Sicht bedenkenlos in allen Schienenfahrzeugen eingesetzt werden.

Exceeding the demands of EN 45545-3!

The aim of **EN 45545-3** is to limit fire spread by specifying the performance of materials and components. If cables are routed through fire barriers, the requirements apply also to the cable glands used.

AGRO Progress® metal cable glands easily exceed the requirements of **EN 45545-3** and satisfy the very high demands of fire resistance class **E30**. This means that the seal inserts remain impervious and prevent the spread of fire through the gland for at least 30 minutes. They do not crack or fissure. From a fire protection perspective, they can be used without hesitation in all railway vehicles.

	Einbaulage vertikal Vertical installation	Einbaulage horizontal Horizontal installation	Klassierung Classification
AGRO Resultat AGRO Result	44 min	41 min	E30

AGRO Kabelverschraubungen Progress® nach EN 45545-2

AGRO Cable glands Progress® according to EN 45545-2

Lange und kurze Anschlussgewinde metrisch, Pg | Long and short entry threads metric, Pg

Material: Messing vernickelt
Material Dichteinsatz: Spezial AGRO TPE
Farbe Dichteinsatz: Hellgrau RAL 7035
Gewinde: M12 bis M63
Pg 7 bis Pg48
Einsatztemperatur: -50°C / +105°C
Schutzart: IP 68 / IP 69 K
Normen: EN 50262 / EN 62444

Material: Nickel-plated brass
Material sealing insert: Special AGRO TPE
Colour sealing insert: Light grey RAL 7035
Threads: M12 to M63
Pg 7 to Pg48
Temperature range: -50°C / +105°C
Protection class: IP 68 / IP 69 K
Norms: EN 50262 / EN 62444



Alle Kabelverschraubungen, welche mit Dichteinsätzen für Bahnapplikationen gemäss EN 45545 erhältlich sind, sind im Katalog mit einem entsprechenden Vermerk gekennzeichnet.

Suchen Sie im Katalog oder auf der Website die Standard-Kabelverschraubung mit dem gewünschten Klemmbereich und dem benötigten Gewinde. Stellen Sie der betreffenden Artikel Nummer den Grossbuchstaben „F“ voran und sie werden die Variante mit Dichteinsatz in Spezial TPE erhalten.

Eine Kabelverschraubung M20 mit einem langen metrischen Anschlussgewinde und einem Klemmbereich von 8.0 - 14.5 mm erhält die Artikel Nummer F1160.20. Zur Vereinfachung benutzen Sie den Produktfinder auf unserer Website www.agro.ch.

All cable glands, which are available with sealing inserts for railway applications according to EN 45545 are marked in the catalogue with an appropriate note.

Search the standard cable gland with the desired clamping range as well as with the required entry thread in our catalogue or on the website. When placing an order or inquiry, prefix the article number by the capital „F“ and you will get the version with sealing insert made of special TPE.

A cable gland M20 with a long metric entry thread and a clamping range of 8.0 - 14.5 mm gets the item number F1160.20. The Product Finder on our website www.agro.ch simplifies your research.

AGRO Kabelverschraubungen

Navigationspfad →

ÜBERSICHT

PRODUKTSUCHE

Installationsart (2)

ALLE

Material (1)

Messing vernickelt

Gewinde (1)

M20x1.5

Minimale Einsatztemperatur (4)

ALLE

Maximale Einsatztemperatur (4)

ALLE

Kabeldurchmesser (mm)

14

63 Produkte

FILTER ZURÜCKSETZEN

Produkt

Artikelnummer



Kabelverschraubungen Progress® Messing

Gewinde: M20x1.5
 minimaler Klemmbereich: 8.0
 maximaler Klemmbereich: 14.5

F 1160.20

MERKEN



EX Kabelverschraubungen

EX cable glands

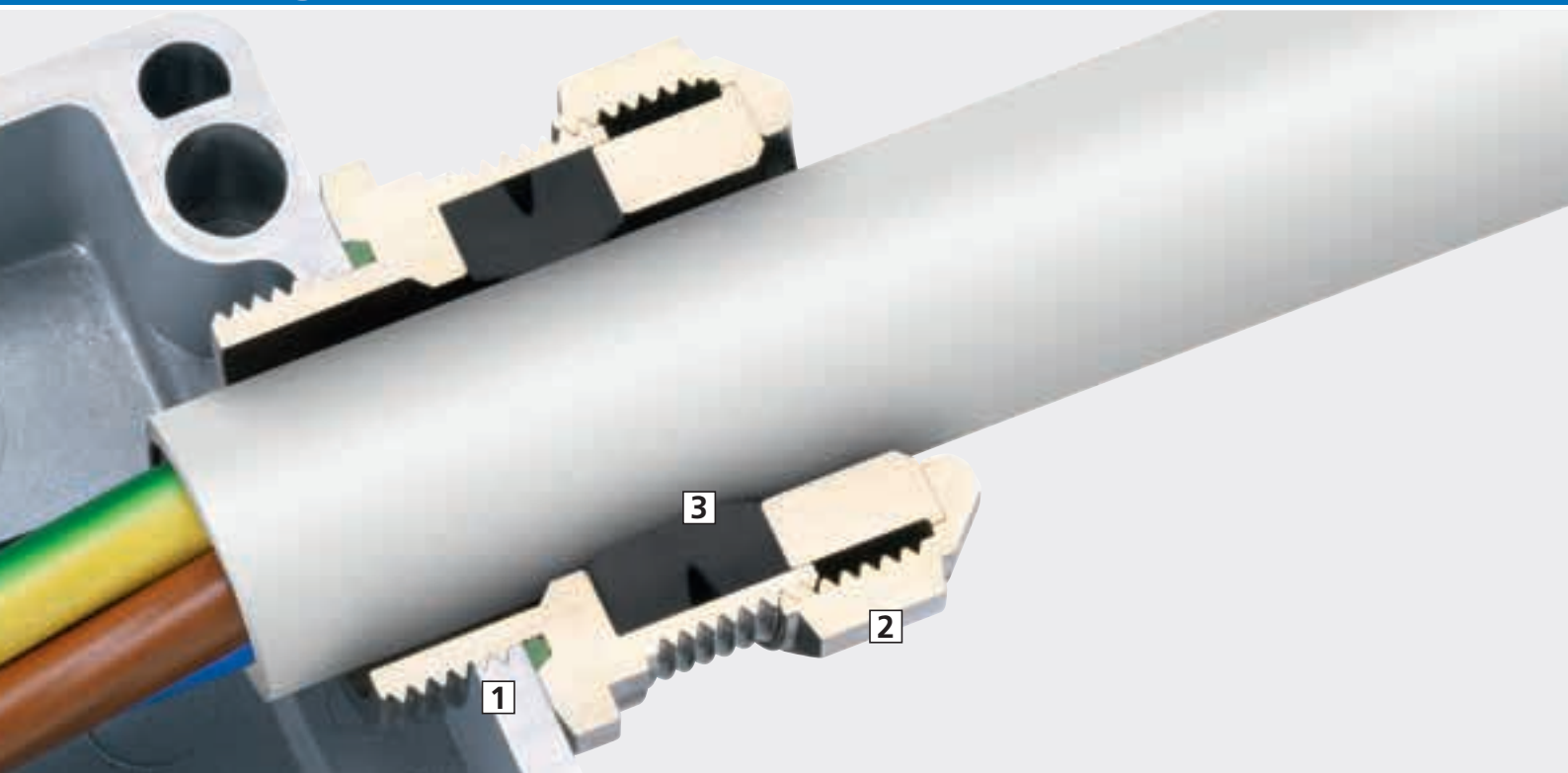

In vielen Bereichen wie zum Beispiel der Chemischen Industrie, Lackierereien, Offshore, Raffinerien, Tankstellen, Textil- und Papierindustrie, Nahrungsmittelindustrie, Glas- und/oder Keramikindustrie, Holzverarbeitung und in vielen weiteren Industrien, werden Geräte in explosionsgefährdeten Bereichen betrieben. Aufgrund der hohen Gefährdung von Personen sowie Sachwerten im Falle einer Explosion gelten speziell in explosionsgefährdeten Bereichen besonders strenge rechtliche und technische Anforderungen. AGRO Ex-Kabelverschraubungen aus Messing oder Kunststoff erfüllen die strengsten Anforderungen und sorgen in explosionsgefährdeten Bereichen für eine sichere Kabeleinführung. Alle Kabelverschraubungen sind zertifiziert und haben eine entsprechende EG-Baumusterprüfbescheinigung. Durch die IECEx Zertifizierung ist ein weltweiter Einsatz möglich.

1 Kurze, lange oder Spezial-Anschlussgewinde

Ex Kabelverschraubungen Progress® mit kurzem oder langem Anschlussgewinde in metrischer, Pg-, Gasrohr oder NPT-Ausführung können bei vorhandenem Gewinde oder Durchgangsbohrung mit Gegenmutter verwendet werden.

2 Stabile Schlüsselflächen

Grosse, stabile Schlüsselflächen an der Druckmutter vereinfachen das Anziehen mit dem Montagewerkzeug.

3 Garantierte Dichtigkeit

Auf den Dichteinsatz abgestimmte Innenkonturen sorgen für eine zielgerichtete Verformung des Dichteinsatzes und garantieren somit dessen perfekte Abdichtung. Die Schutzart IP 68 bis 10 bar (druckfeste Kapselung 30 bar) sowie IP 69K ermöglichen eine breite Anwendung.

In many areas such as the chemical industry, paint shops, offshore refineries, petrol stations, the textile and paper industry, the food industry, glass and / or ceramics industry, wood processing and many other industries, equipment are operated in explosive areas. Due to the high risk to persons and property in case of an explosion, especially strict legal and technical requirements apply to explosive areas in particular. AGRO Ex cable glands made of brass or plastic comply with the strictest requirements and ensure safe cable entry in explosive areas. All cable glands are certified accordingly and come with an EC type-examination certificate. IECEx certification allows for worldwide use.

1 Short, long or special entry thread

Ex Cable glands Progress® with short or long entry thread designed as metric, Pg, gas-pipe or NPT can be used with existing opening threads or with a counter nut.

2 Stable spanner flats

Large, stable spanner flats on the nut simplify tightening using the assembly tool.

3 Guaranteed seal

Inner contours matched to the sealing insert ensure a targeted deformation of the insert and thus guarantee its tightness in compliance with protection class IP 68 up to 10 bar (flameproof enclosure 30 bar) and IP 69K for a wide range of applications.¥



<p>Kabelverschraubungen Messing druckfeste Kapselung Ex d IIC Cable glands nickel-plated brass for flameproof enclosure Ex d IIC</p>		<p>115 - 117</p>	<p>1</p>
<p>Kabelverschraubungen Ex Compact Messing druckfeste Kapselung Ex d IIC / Ex e II Cable glands Ex Compact nickel-plated brass for flameproof enclosure Ex d IIC</p>		<p>118</p>	<p>2</p>
<p>Zubehör zu Kabelverschraubungen Messing druckfeste Kapselung Ex d IIC Cable gland accessoires nickel-plated brass for flameproof enclosure Ex d IIC</p>		<p>119 - 120</p>	<p>3</p>
<p>Kabelverschraubungen Progress® Messing erhöhte Sicherheit Ex e II Cable glands Progress® nickel-plated brass increased safety Ex e II</p>		<p>121 - 122</p>	<p>4</p>
<p>Kabelverschraubungen Progress® Messing für mehrere Kabel erhöhte Sicherheit Ex e II Cable glands Progress® nickel-plated brass for installation of multiple cables increased safety Ex e II</p>		<p>123 - 124</p>	<p>5</p>
<p>Kabelverschraubungen Progress® Messing mit Klemmbacken erhöhte Sicherheit Ex e II Cable glands Progress® nickel-plated brass with clamps increased safety Ex e II</p>		<p>125 - 127</p>	<p>6</p>
<p>Kabelverschraubungen Progress® Messing mit Trompete und Klemmbacken erhöhte Sicherheit Ex e II Cable glands Progress® nickel-plated brass with trumpet and clamps increased safety Ex e II</p>		<p>128 - 129</p>	<p>7</p>
<p>Kabelverschraubungen Progress® EMV Rapid Messing mit Kontaktscheibe erhöhte Sicherheit Ex e II Cable glands Progress® EMC Rapid nickel-plated brass with contact disc increased safety Ex e II</p>		<p>130</p>	<p>8</p>
<p>Kabelverschraubungen Progress® EMV Messing mit Kontakthülse erhöhte Sicherheit Ex e II Cable glands Progress® EMC nickel-plated brass with contact sleeve increased safety Ex e II</p>		<p>131 - 132</p>	<p>9</p>
<p>Kabelverschraubungen Progress® EMV Messing mit Kontakthülse und Klemmbacken erhöhte Sicherheit Ex e II Cable glands Progress® EMC nickel-plated brass with contact sleeve and clamps increased safety Ex e II</p>		<p>133 - 134</p>	<p>10</p>
<p>Kombi-Schlauchverschraubung Progress® Messing erhöhte Sicherheit Ex e II Combination conduit glands Progress® nickel-plated brass increased safety Ex e II</p>		<p>135</p>	<p>11</p>
<p>Kabelverschraubungen Progress® Kunststoff GFK erhöhte Sicherheit Ex e II Synthetic cable glands Progress® GFK increased safety Ex e II</p>		<p>136 - 139</p>	<p>12</p>
<p>Kabelverschraubungen Progress® Kunststoff GFK für mehrere Kabel erhöhte Sicherheit Ex e II Synthetic cable glands Progress® GFK for installation of multiple cables increased safety Ex e II</p>		<p>140 - 141</p>	<p>13</p>
<p>Kabelverschraubungen Progress® Kunststoff GFK erhöhte Sicherheit Ex e II und Eigensicherheit Ex i II Synthetic cable glands Progress® GFK increased safety Ex e II and intrinsic safety Ex i II</p>		<p>142 - 143</p>	<p>14</p>
<p>Zubehör zu Kabelverschraubungen Messing und Kunststoff erhöhte Sicherheit Ex e II Cable gland accessoires nickel-plated brass and synthetic for flameproof enclosure Ex d IIC</p>		<p>144 - 149</p>	<p>15</p>

Richtlinien & Vorschriften

ATEX 95 (Richtlinie 94/9 EG)

1994 nahm der Europäische Rat die Richtlinie 94/9 EG „Für Geräte und Schutzsysteme zur bestimmungsgemässen Verwendung in explosionsgefährdeten Bereichen“ an. Diese Richtlinie, bekannt als ATEX95 (vom französischen „atmosphère explosible“), regelt den Explosionsschutz in elektrischen Anlagen auf dem Gebiet der EU.

Die ATEX95 definiert im Anhang verschiedene Module für die Inverkehrbringung von Geräten für den Einsatz in explosionsgefährdeten Bereichen. Oft verwendet, so auch bei AGRO, werden die Module III und IV, woraus folgende Zertifikate resultieren:

- Die EG Baumusterprüfbescheinigung
- Die QS-Anerkennung

➔ Neue Richtlinie 2014/34 EU ab 20.04.2016

Beide Zertifikate werden von akkreditierten Prüfstellen nach erfolgreich absolvierten Prüfungen ausgestellt.

EG-Baumusterprüfbescheinigung

Die EG-Baumusterprüfbescheinigung ist dasjenige Dokument, welches auf Grund der erfolgreichen technischen Prüfungen ausgestellt wird.

QS-Anerkennung

Eine Forderung aus der ATEX95 ist die geprüfte und überwachte Produktion. Sie stellt sicher, dass die in Verkehr gebrachten Produkte mit den Prüfmustern der EG-Baumusterprüfbescheinigung übereinstimmen. Für Firmen, welche über ein zertifiziertes QM-System nach ISO 9001:2008 verfügen, wird ein zusätzliches Ex-Audit nötig. Ihm folgen in periodischen Abständen Wiederholungs-Audits.

CE-Konformitätserklärung

Auf der EG-Baumusterprüfbescheinigung und der QS-Anerkennung basiert die CE-Konformitätserklärung. Damit erklärt der Hersteller die Einhaltung der geltenden Normen und Vorschriften. Sichtbar wird dies durch die CE-Kennzeichnung.

Installation



Für das Errichten und Betreiben sind die Vorschriften gemäss IEC / EN 60079-14, das Gerätesicherheitsgesetz, die allgemein anerkannten Regeln der Technik und diese Betriebsanleitung massgebend. Damit der geforderte IP-Schutzgrad gemäss EN 60529:2014 erreicht wird, müssen die Verschraubungen sachgerecht im elektrischen Betriebsmittel eingebaut werden.

Bei Montage von Erweiterung oder Reduzierung ist darauf zu achten, dass maximal 1 Stk. eingebaut wird. Das Ineinanderschrauben mehrerer Reduktionen / Erweiterungen ist nach Norm nicht zulässig!

Bitte beachten Sie unbedingt unsere Montage-, Betriebs- und Wartungsanleitungen in den Zusatzinformationen Kapitel 12

Die Daten der Kabelverschraubungen unter Punkt 3 sind beim Einbau zu berücksichtigen. Beim Einsatz in Kunststoffgehäuse müssen die Kabelverschraubungen in den Potentialausgleich einbezogen werden. Die auf der Tabelle für die jeweiligen Grössen angegebenen Anzugsdrehmomente für die Druckmutter und die Klemmbackenschrauben sowie die ergänzenden Hinweise sind zu beachten.

Instandhaltung



Die für Wartung, Instandhaltung und Prüfung geltenden Bestimmungen der IEC / EN 60079-14 sind einzuhalten. Im Rahmen der Wartung sind vor allem die für die Zündschutzart massgebenden Teile zu prüfen.

Directives & Regulations

ATEX95 + Directive 94/9 EC

In 1994, the Council of Europe adopted Directive 94/9 EC «For equipment and protective systems» for use for the intended purpose in potentially explosive areas. This, known as ATEX95 (from the French «atmosphère explosible»), regulates the explosion protection in electrical installations in the EU.

In its appendix the ATEX95 defines various modules for bringing into circulation equipment for use in potentially explosive atmospheres. Frequently used, as is also the case at AGRO, are modules III and IV which give rise to two certificates.

- The EC design test certificate
- The QA certificate

➔ New Directive 2014/34 EU from 20.04.2016 on

Both certificates are issued by accredited test centres after successful tests.

EC type test certificate

The EC examination test certificate is the document which is issued on the basis of successful technical tests.

QA certificate

A feature of ATEX95 is tested and monitored production. It ensures that the products brought onto the market correspond to the test samples of the EC design test certificate. For companies which have a certified QM system according to ISO 9001:2008, an additional explosion audit is necessary. It is followed by repeat audits at periodic intervals.

CE Declaration of Conformity

The CE Declaration of Conformity is based on the EC design test certificate and the QA certificate. With this, the manufacturer declares compliance with the valid standards and regulations. This is evident from the CE symbol, which is part of the marking.

Installation



The regulations according to IEC / EN 60079-14, the equipment safety law, the generally acknowledged rules of the industry and these operating instructions are applicable for installation and operation. In order to ensure the required IP protection category according to EN 60529:2014 is achieved, the cable glands must be properly installed in the electrical equipment.

When installing enlarging or reduction fittings, make sure to install one piece only. The norm interdicts to screw several reduction / enlarging fittings into each other!

Please unconditionally take into account our assembly, instruction and maintenance guidelines in chapter 12, additional information.

The data for the cable gland under section 3 must be taken into account on installation. When used in enclosures made of plastic, the cable glands must be included in the equipotential bonding system. The tightening torques stated in the table for the respective sizes of compression cap nuts and clamps and the additional information must be taken into account.

Maintenance



The provisions of IEC / EN 60079-14 which are applicable for service, maintenance and testing must be complied with. During maintenance, in particular the parts critical for the ignition protection category must be tested.

In Produktions- und Arbeitsstätten können sich Gefahrenbereiche für Explosionen ausbilden, wenn die ersten zwei Voraussetzungen für eine Explosion erfüllt sind. Typische Gefahrenbereiche entstehen in chemischen Fabriken, Raffinerien, Lackfabriken, Lackierereien, Reinigungsanlagen, Mühlen und Lagern für Mahlprodukte, Grossbäckereien und anderen brennbaren Stäuben, in Tank- und Verladeanlagen für brennbare Gase, Flüssigkeiten und Feststoffe.

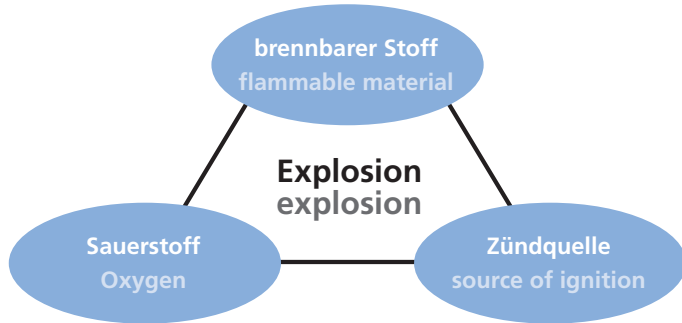

In production and work places, explosive areas may arise when the first two preconditions for an explosion are met. Typical danger zones are created in chemical factories, refineries, paint and varnish factories, paint shops, cleaning plants, mills and storehouses for mill products, large bakeries and other flammable dusts, in tank and loading facilities for inflammable gases, liquids and solid matter.

Beispiele für Zoneneinteilungen im Ex-Bereich

Examples for zone classifications in hazardous area

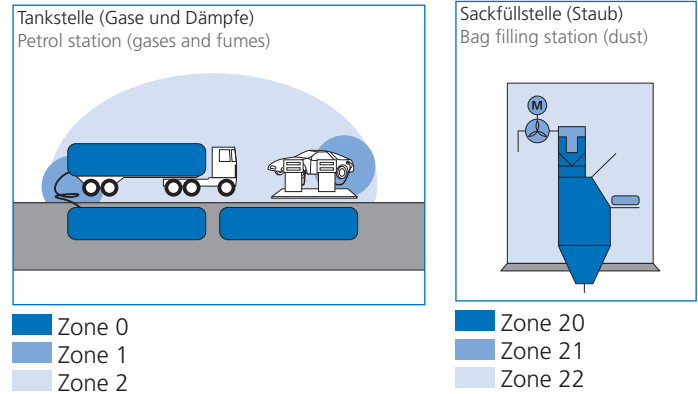

Weiterhin spielt für das Entstehen einer Explosion die Konstellation dieser Faktoren eine Rolle. So kann z.B. eine übersättigte Atmosphäre nicht zünden (Gemisch zu fett) ebenso eine Atmosphäre mit zu hohem Sauerstoffanteil (Gemisch zu mager).

Furthermore, for the appearance of an explosion, the constellation of these factors is important. If the atmosphere is saturated (rich mixture) it cannot ignite, also if the proportion of oxygen is too high (lean mixture).

Die Gerätekennzeichnung – unterschieden durch Buchstaben – sagt etwas über die explosionsfähigen Stoffe aus:

The marking of devices, varied by letters, gives information about the flammable material:

- M** vorangestellt steht für untertägige Bergwerke
- G** nachgestellt steht für brennbare Gase, Nebel oder Dämpfe und
- D** nachgestellt für Stäube

- M** mining
- G** flammable gas, fog, steam
- D** flammable dust

Ziffern drücken den Grad aus.

Figures express the level.

- 1** steht für ein sehr hohes Mass an Sicherheit
- 2** steht für ein hohes Mass an Sicherheit
- 3** steht für ein normales Mass an Sicherheit

- 1** very high degree of safety
- 2** high degree of safety
- 3** normal degree of safety

Damit ergibt sich die Zuordnung der Gerätekategorien zu den Zonen.

The outcome of this is the assignment of devices by zones.

Die Definition der Ex-Zonen und der Zusammenhang der explosionsgefährdeten Bereiche mit der Häufigkeit der Zündquellen im Übertagebetrieb.

The definition of the hazardous area and the combination between explosive areas and frequency by sources of ignition (no mining)

Zoneneinteilung / Zone classification						
	Gas / gas			Staub / dust		
	Zone 0	Zone 1	Zone 2	Zone 20	Zone 21	Zone 22
Häufigkeit der Explosionsgefahr frequency of explosion risk	ständig oder langfristig allways or long-term	gelegentlich casual	selten und kurzfristig rare and for a short time	wie Zone 0 Staubablagerungen allein bilden keine Zone 20 like zone 0 dust deposit alone is not generate zone 20	wie Zone 1 like zone 1	wie Zone 2 oder wenn Staubanhäufungen vorhanden sind like zone 2 or if dust deposit occurs
Häufigkeit der Zündquellen von elektrischen Betriebsmitteln frequency sources of ignition in electrical equipment	niemals (auch nicht bei seltenen Betriebsstörungen) never (also not on rare breakdowns)	sehr selten (auch nicht bei häufiger zu erwartenden Betriebsstörungen) very rare (also not on frequently expected disturbances)	gelegentlich (z.B. bei Betriebsstörung) casual (e.g. on disturbances)	wie Zone 0 like zone 0	wie Zone 1 like zone 1	wie Zone 2 like zone 2

Generelle Informationen Explosionsschutz

Information about explosion protection

Gerätezuordnung nach Zonen Device assignment by zones			
Bereich Range	Stufe Explosionsgefahr Level explosion risk	Erforderliche Kennzeichnung der einsetzbaren Betriebsmittel Required marking of applicable equipment	
		Gerätegruppe* / Device*	Kategorie / Category
Gruppe II group II	Zone 0	II	1 G
Gruppe II group II	Zone 1	II	2 G oder / or 1 G
Gruppe II group II	Zone 2	II	3 G oder / or 2 G
Gruppe II group II	Zone 20	II	1 D
Gruppe II group II	Zone 21	II	2 D oder / or 1 D
Gruppe II group II	Zone 22	II	3 D oder wie / or like 2 D

* Die Geräte werden in zwei Gruppen unterteilt. Gruppe 1 gilt für schlagwettergefährdete Geräte zur Verwendung im Bergbau und wird hier nicht weiter beschrieben.
The equipment is divided into two groups. Group 1 is applicable to equipment at risk from firedamp and intended for use in mining and will not be describe further here.



Für elektrische Betriebsmittel der Gruppe II wird weiter eine Unterteilung in Explosionsgruppen und Temperaturklassen vorgenommen.

For electrical equipment of group II a further classification in explosion group and temperature classes has been taken.

Einteilung in Temperaturklassen Classification by temeratur class		
Zündtemperatur in °C Ignition temperature in °C	Temperaturklasse Temperature class	max. Oberflächentemperatur in °C des Betriebsmittels max. surface temperature in °C
≥ 450	T1	450
300-450	T2	300
200-300	T3	200
135-200	T4	135
100-135	T5	100
85-100	T6	85



Einteilung von Explosionsgruppen bei Gas- Ex-Schutz

Brennbare Gase/Dämpfe/Nebel unterscheiden sich in ihrem Zünddurchschlagsvermögen. Daher unterteilt man sie in Explosionsgruppen. Durch Versuchsreihen wurde hierbei die Grenzspaltweite MESG (Maximum Experimental Safe Gap) und der Mindestzündstrom MIC (Minimum Ignition Current) ermittelt. Die Gefährlichkeit der Gase nimmt hierbei von IIA nach IIC zu.

Classification of explosion groups for gas protection

Flamable gas/steam/fog differs in it's ignition breakdown capacity. Therefore they are classified in explosion groups. Test series showed the MESG (Maximum Experimental Safe Gap) and the MIC (Minimum Ignition Current) The risikness riscs from IIA to IIC.

Explosionsgruppe Explosions group	Grenzspaltwerte MESG Maximum experimental safe gap	Mindestzündstromverhältnis bezogen auf Methan Minimum ignition current relating to methane
II A	> 0.9 mm	> 0.8
II B	0.5 mm bis 0.9 mm	0.45 bis 0.8
II C	< 0.9 mm	< 0.45

Schematische Darstellung der Funktionsprinzipien von einzelnen Zündschutzarten für die AGRO Kabelverschraubungen anbietet

Schematical diagram of functional principle of some protection types, for which offers AGRO cable glands

Zündschutzart nach IEC bzw. EN type of protection by IEC and/or EN	Grundprinzip basic principle	Schematische Darstellung schematic view
IEC / EN 60079-1	<p>Ex d druckfeste Kapselung</p> <p>Kommt es im Innern eines druckfest gekapselten Gehäuses zu einer Explosion wird eine Übertragung der Explosion nach aussen ausgeschlossen</p> <p>Ex d flameproof enclosures</p> <p>If an explosion occurs within a flameproof enclosure the escape to outside atmosphere will be prevented</p>	
IEC / EN 60079-7	<p>Ex e erhöhte Sicherheit</p> <p>Die Entstehung von Funken und hohen Temperaturen wird mit einem erhöhten Grad an Sicherheit ausgeschlossen</p> <p>Ex e increased safety</p> <p>The appearance of sparks ignitions and / or high temperatur is prevented by an increased level of security standard.</p>	
IEC / EN 60079-11	<p>Ex i Eigensicherheit</p> <p>Die Energie im Stromkreis wird so gering gehalten, dass zündfähige Funken, Lichtbögen oder hohe Temperaturen nicht entstehen können</p> <p>Ex i intrinsic safety</p> <p>The curcuit energy has to be kept under a certain level to prevent the appearance of ignitable sparks, electrical arcs and high temperature</p>	



Anwendungen

Die AGRO Kabelverschraubungen für explosionsgeschützte Geräte sind somit für die meisten Anwendungen an explosionsgeschützten Motoren, Schalt- und Steuergeräten, Gehäusen usw. geeignet, die in der Industrie, in der chemischen und petrochemischen Industrie eingesetzt werden.

Applications

The AGRO cable glands for explosion-protected equipment are therefore suitable for most of the applications in explosion-hazardous motors, switch and control gears, housings etc. used in industrial fields such as in the machinery and automation industry, in the chemical and petrochemical industry.



Kabelverschraubung Messing
Cable glands nickel-plated brass
druckfeste Kapselung (Serie 18)
flameproof enclosure (Serie 18)
druckfeste Kapselung (Serie 18)
flameproof enclosure (Serie 18)
Progress® Messing (Ex Compact)
Standard
für mehrere Kabel
for installation of multiple cables
mit Klemmbacken
with clamps
mit Trompete und Klemmbacken
with trumpet and clamps
EMV
EMC
Progress® Kunststoff (GFK)
Standard
Standard
für mehrere Kabel
for installation of multiple cables
Zubehör
Accessories
Reduktionen Messing
Reducers nickel-plated brass
Erweiterungen Messing
Expanders nickel-plated brass
Adapter Messing
Adapters nickel-plated brass
Verschlusschrauben
Locking screw

Ausführung / Version																	
Kompressionstechnik Compression technology		•	•		•	•	•	•	•		•	•		-	-	-	-
Zündschutzart ... Ignition protection categories		d	d		e	e	e	e	e		e/i	e/i		e	e	e	d/e
EMV Technik / EMC technology																	
Kontakthülse Contact sleeve		-	-		-	-	-	-	•		-	-		-	-	-	-
Kontaktscheibe Contact disc		-	-		-	-	-	-	•		-	-		-	-	-	-
Gewinde / Thread																	
Anschlussgewinde metrisch Entry thread metric		•	•		•	•	•	•	•		•	•		-	-	-	•
Anschlussgewinde Pg Entry thread Pg		•	-		•	•	•	•	•		•	•		-	-	-	•
Anschlussgewinde NPT Entry thread NPT		•	-		-	-	-	-	-		-	-		-	-	-	-
Anschlussgewinde Gasrohr Entry thread gas pipe		•	-		-	-	-	-	-		-	-		-	-	-	-
Aussengewinde metrisch - Innengewinde metrisch External thread metric - internal thread metric		-	-		-	-	-	-	-		-	-		•	•	-	-
Aussengewinde Pg - Innengewinde metrisch External thread Pg - internal thread metric		-	-		-	-	-	-	-		-	-		-	-	•	-
Kurzes Anschlussgewinde Short entry thread		-	-		•	•	•	•	•		•	•		•	•	•	•
Langes Anschlussgewinde Long entry thread		•	•		•	-	-	•	-		-	-		-	-	-	-
Dichteinsatz / Sealing insert																	
einteiliger Dichteinsatz One-piece sealing insert		•	•		•	•	-	-	•		•	•		-	-	-	-
zweiteiliger Dichteinsatz Two-piece sealing insert		-	-		-	-	•	•	-		-	-		-	-	-	-
für mehrere Kabel for installation of multiple cables		-	-		-	•	-	-	-		-	•		-	-	-	-
Standard-Dichteinsatz (TPE / NBR) Standard sealing insert (TPE/NBR)		•	•		•	•	•	•	•		•	•		-	-	-	-
Technische Besonderheiten / Technical features																	
Zugentlastung Strain relief		•	•		•	•	•	•	•		•	•		-	-	-	-
Vibrationsschutz Vibration resistance		•	•		•	•	•	•	•		•	•		-	-	-	-
mechanische Zugentlastung mechanical strain relief		-	-		-	-	•	-	•		-	-		-	-	-	-
mit Biegeschutz und mecha- nischer Zugentlastung with bending protection and mechanical strain relief		•	-		-	-	-	•	-		-	-		-	-	-	-

AGRO Ex Kabelverschraubungen Messing druckfeste Kapselung Ex d IIC

AGRO Ex cable glands nickel-plated brass for flameproof enclosure Ex d IIC

Anschlussgewinde metrisch | Entry thread metric

Material: Messing vernickelt
 Schrauben: Rostfreier Stahl A2
 Dichtung: NBR
 Einsatztemperatur: -40°C / +100°C
 Schutzart: IP 68 (30 bar) / IP 69K
 Prüfnorm: IEC EN 60079-0 / IEC EN 60079-1 / IEC EN 60079-31
 Kategorie 2G: II 2G Ex db eb IIC
 Kategorie 2D: II 2D Ex ta IIIC
 Zone: Gas 1 und 2 / Staub 21 und 22
 Zertifikat: EG-Baumusterprüfbescheinigung PTB 00 ATEX 1059
 IECEx Zertifikat: IECEx PTB 12.0056

Material: Nickel-plated brass
 Screws: Stainless steel A2
 Seal: NBR
 Temperature range: -40°C / +100°C
 Protection class: IP 68 (30 bar) / IP 69K
 Test standard: IEC EN 60079-0 / IEC EN 60079-1 / IEC EN 60079-31
 Kategorie 2G: II 2G Ex db eb IIC
 Kategorie 2D: II 2D Ex ta IIIC
 Zone: Gas 1 and 2 / dust 21 and 22
 Certificate: EC-type examination certificate PTB 00 ATEX 1059
 IECEx Certificate: IECEx PTB 12.0056

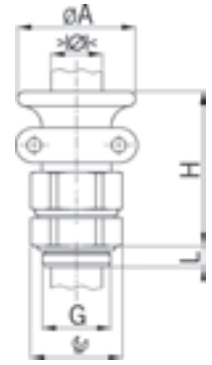

Einteiliger Dichteinsatz
 nicht durchgehend isolierend

One-piece sealing insert
 not overall length insulated

G	>Ø< min mm	>Ø< max mm	IP	ØA mm	H mm	L mm	Art.-Nr. Art. No.	
M16x1.5	7.0	9.0	20	27	57	12	1817.09.26	25
M20x1.5	9.0	11.0	24	30	57	12	1820.11.26	25
M20x1.5	11.0	13.0	26	32	57	14	1820.16.26	25
M25x1.5	13.0	16.5	32	40	67	16	1825.21.26	10
M25x1.5	16.5	20.0	36	44	67	16	1825.21.27	10
M32x1.5	20.0	24.0	46	48	78	17	1832.29.26	5
M40x1.5	24.0	28.0	46	52	78	17	1840.29.27	5
M50x1.5	28.0	32.0	55	60	85	17	1850.36.26	5
M50x1.5	32.0	36.0	55	64	85	17	1850.36.27	5
M63x1.5	36.0	40.0	70	75	88	20	1863.48.26	1
M63x1.5	40.0	44.0	70	80	88	20	1863.48.27	1



AGRO Ex Kabelverschraubungen Messing druckfeste Kapselung Ex d IIC

AGRO Ex cable glands nickel-plated brass for flameproof enclosure Ex d IIC

Anschlussgewinde Pg | Entry thread Pg

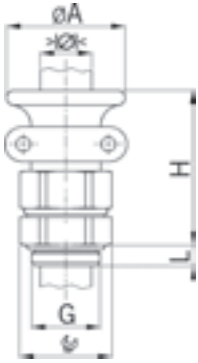

Material: Messing vernickelt
 Schrauben: Rostfreier Stahl A2
 Dichtung: NBR
 Einsatztemperatur: -40°C / +100°C
 Schutzart: IP 68 (30 bar) / IP 69K
 Prüfnorm: IEC EN 60079-0 / IEC EN 60079-1 / IEC EN 60079-31
 Kategorie 2G: II 2G Ex db eb IIC
 Kategorie 2D: II 2D Ex ta IIIC
 Zone: Gas 1 und 2 / Staub 21 und 22
 Zertifikat: EG-Baumusterprüfbescheinigung PTB 00 ATEX 1059
 IECEx Zertifikat: IECEx PTB 12.0056

Material: Nickel-plated brass
 Screws: Stainless steel A2
 Seal: NBR
 Temperature range: -40°C / +100°C
 Protection class: IP 68 (30 bar) / IP 69K
 Test standard: IEC EN 60079-0 / IEC EN 60079-1 / IEC EN 60079-31
 Category 2G: II 2G Ex db eb IIC
 Category 2D: II 2D Ex ta IIIC
 Zone: Gas 1 and 2 / dust 21 and 22
 Certificate: EC-type examination certificate PTB 00 ATEX 1059
 IECEx Certificate: IECEx PTB 12.0056



Einteiliger Dichteinsatz
 nicht durchgehend isolierend

One-piece sealing insert
 not overall length insulated

G	>Ø< min mm	>Ø< max mm	IP	ØA mm	H mm	L mm	Art.-Nr. Art. No.	
Pg 9	7.0	9.0	20	27	57	12	1809.26	25
Pg 11	9.0	11.0	24	30	57	12	1811.26	25
Pg 13	11.0	13.0	26	32	57	14	1813.26	25
Pg 16	11.0	13.0	26	32	57	14	1816.26	25
Pg 21	13.0	16.5	32	40	67	16	1821.26	10
Pg 21	16.5	20.0	36	44	67	16	1821.27	10
Pg 29	20.0	24.0	45	48	78	17	1829.26	5
Pg 29	24.0	28.0	45	52	78	17	1829.27	5
Pg 36	28.0	32.0	55	60	85	17	1836.26	5
Pg 36	32.0	36.0	55	64	85	17	1836.27	5
Pg 48	36.0	40.0	64	75	88	20	1848.48.26	1
Pg 48	40.0	44.0	64	80	88	20	1848.48.27	1

Anschlussgewinde Gasrohr | Gas-pipe entry thread



Einteiliger Dichteinsatz
 nicht durchgehend isolierend

One-piece sealing insert
 not overall length insulated

G	>Ø< min mm	>Ø< max mm	IP	ØA mm	H mm	L mm	Art.-Nr. Art. No.	
G 3/8"	7.0	9.0	20	27	57	12	183/8G.09.26	25
G 1/2"	9.0	11.0	24	30	57	14	181/2G.11.26	25
G 1/2"	11.0	13.0	26	32	57	14	181/2G.16.26	25
G 3/4"	13.0	16.5	32	40	67	16	183/4G.21.26	10
G 3/4"	16.5	20.0	36	44	67	16	183/4G.21.27	10
G 1"	20.0	24.0	45	48	78	17	181G.29.26	5
G 1 1/4"	24.0	28.0	45	52	78	17	1811/4G.29.27	5
G 1 1/2"	28.0	32.0	55	60	85	17	1811/2G.36.26	5
G 2"	36.0	40.0	64	75	88	20	1848.26	1
G 2"	40.0	44.0	64	80	88	20	1848.27	1

AGRO Ex Kabelverschraubungen Messing druckfeste Kapselung Ex d IIC

AGRO Ex cable glands nickel-plated brass for flameproof enclosure Ex d IIC

Anschlussgewinde NPT | Entry thread NPT

Material: Messing vernickelt
 Schrauben: Rostfreier Stahl A2
 Dichtung: NBR
 Einsatztemperatur: -40°C / +100°C
 Schutzart: IP 68, wenn Anschluss-
 gewinde abgedichtet
 Weitere Schutzart: IP 69K
 Prüfnorm: IEC EN 60079-0 /
 IEC EN 60079-1 /
 IEC EN 60079-31
 Kategorie 2G: II 2G Ex db eb IIC
 Kategorie 2D: II 2D Ex ta IIIC
 Zone: Gas 1 und 2 / Staub 21
 und 22
 Zertifikat: EG-Baumuster-
 prüfbescheinigung
 PTB 00 ATEX 1059
 IECEx Zertifikat: IECEx PTB 12.0056

Material: Nickel-plated brass
 Screws: Stainless steel A2
 Seal: NBR
 Temperature range: -40°C / +100°C
 Protection class: IP 68, if the entry thread
 is sealed
 Further protection: IP 69K
 Test standard: IEC EN 60079-0 /
 IEC EN 60079-1 /
 IEC EN 60079-31
 Kategorie 2G: II 2G Ex db eb IIC
 Kategorie 2D: II 2D Ex ta IIIC
 Zone: Gas 1 and 2 / dust 21
 and 22
 Certificate: EC-type exami-
 nation certificate
 PTB 00 ATEX 1059
 IECEx Certificate: IECEx PTB 12.0056

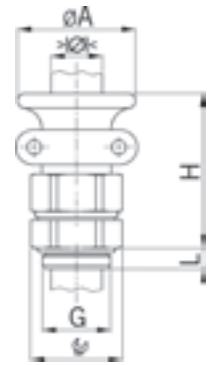

Einteiliger Dichteinsatz
 nicht durchgehend isolierend

One-piece sealing insert
 not overall length insulated

G	>Ø< min mm	>Ø< max mm		ØA mm	H mm	L mm	Art.-Nr. Art. No.	
NPT 3/8"	7.0	9.0	20	27	57	15.5	183/8NPT.09.26	25
NPT 1/2"	9.0	11.0	24	30	57	20	181/2NPT.11.26	25
NPT 1/2"	11.0	13.0	26	32	57	20	181/2NPT.16.26	25
NPT 3/4"	9.0	11.0	27	30	57	20	183/4NPT.11.26	25
NPT 3/4"	11.0	13.0	26	32	57	20	183/4NPT.16.26	25
NPT 3/4"	13.0	16.5	32	40	67	20	183/4NPT.21.26	10
NPT 1"	13.0	16.5	32/34	40	67	25	181NPT.21.26	10
NPT 1"	16.5	20.0	36	44	67	25	181NPT.21.27	10
NPT 1 1/4"	20.0	24.0	45	48	78	26	1811/4NPT.29.26	5
NPT 1 1/4"	24.0	28.0	45	52	78	26	1811/4NPT.29.27	5
NPT 1 1/2"	28.0	32.0	55	60	85	26	1811/2NPT.36.26	5
NPT 1 1/2"	32.0	36.0	55	64	85	26	1811/2NPT.36.27	5



Anschlussgewinde metrisch | Entry thread metric

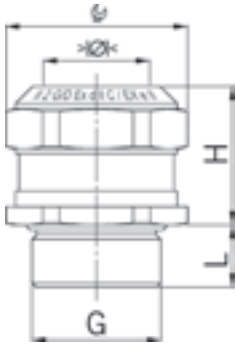

Material: Messing vernickelt
 Dichtung: NBR
 Einsatztemperatur: -60°C / +105°C
 Schutzart: IP 68 (30 bar) / IP 69K
 Prüfnorm: IEC EN 60079-0 / IEC EN 60079-1 / IEC EN 60079-7 / IEC EN 60079-31
 Kategorie 2G: II 2G Ex db eb IIC
 Kategorie 2D: II 2D Ex ta IIIC
 Zone: Gas 1 und 2 / Staub 21 und 22
 Zertifikat: EG-Baumusterprüfbescheinigung PTB 10 ATEX 1034X
 IECEx Zertifikat: IECEx PTB 12.0055X

Material: Nickel-plated brass
 Seal: NBR
 Temperature range: -60°C / +105°C
 Protection class: IP 68 (30 bar) / IP 69K
 Test standard: IEC EN 60079-0 / IEC EN 60079-1 / IEC EN 60079-7 / IEC EN 60079-31
 Category 2G: II 2G Ex db eb IIC
 Category 2D: II 2D Ex ta IIIC
 Zone: Gas 1 and 2 / dust 21 and 22
 Certificate: EC-type-examination certificate PTB 10 ATEX 1034X
 IECEx Certificate: IECEx PTB 12.0055X

EX Compact MS



Einteiliger Dichteinsatz
 nicht durchgehend isolierend

One-piece sealing insert
 not overall length insulated

G	> Ø < min mm	> Ø < max mm		H mm	L mm	Art.-Nr. Art. No.	
M16x1.5	3.0	7.0	21	26	12	EX1126.17.070	25
M16x1.5	5.0	10.0	24	26	12	EX1126.17.100	25
M20x1.5	5.0	11.0	24	26	12	EX1126.20.110	25
M20x1.5	9.0	14.0	30	26	12	EX1126.20.140	25
M25x1.5	7.5	15.0	32	28	12	EX1126.25.150	20
M25x1.5	12.5	18.0	32	28	12	EX1126.25.180	20
M32x1.5	17.0	23.0	41	33	12	EX1126.32.230	10
M32x1.5	21.0	26.0	41	33	12	EX1126.32.260	10
M40x1.5	21.0	26.0	41	33	14	EX1126.40.260	10
M40x1.5	24.0	32.0	50	34	14	EX1126.40.320	10
M50x1.5	28.0	36.0	55	34	14	EX1126.50.360	5
M50x1.5	35.0	42.0	60	35	14	EX1126.50.420	5
M63x1.5	36.0	44.0	65	35	14	EX1126.63.440	1
M63x1.5	43.0	50.0	70	35	14	EX1126.63.500	1

Auf Anfrage lieferbar:

Available on request:

Ausführungen in Stahl A2 und A4, Anschlussgewinde NPT

Executions in steel A2 and A4, entry thread NPT

Zubehör zu Kabelverschraubungen Messing druckfeste Kapselung Ex d IIC

Accessories for cable glands nickel-plated brass for flameproof enclosure Ex d IIC

Anschlussgewinde metrisch | Entry thread metric

Verschlusschrauben Messing druckfeste Kapselung Ex d IIC

Material:	Messing vernickelt
O-Ring :	FPM
Einsatztemperatur:	-40°C / +100°C
Schutzart:	IP 68 (30 bar)
Weitere Schutzart:	IP 69K
Prüfnorm:	IEC EN 60079-0 / IEC EN 60079-1 / IEC EN 60079-31
Kategorie 2G:	Ex d IIC
Kategorie 2D:	Ex tD A21 IP68
Zone:	Gas 1 und 2 / Staub 21 und 22
Zertifikat:	EG-Baumuster- prüfbescheinigung PTB 00 ATEX 1059
IECEx Zertifikat:	IECEx PTB 12.0056

Locking plugs nickel-plated brass flameproof enclosure Ex d IIC

Material:	Nickel-plated brass
O-ring :	FPM
Temperature range:	-40°C / +100°C
Protection class:	IP 68 (30 bar)
Further protection:	IP 69K
Test standard:	IEC EN 60079-0 / IEC EN 60079-1 / IEC EN 60079-31
Category 2G:	Ex d IIC
Category 2D:	Ex tD A21 IP68
Zone:	Gas 1 and 2 / dust 21 and 22
Certificate:	EC-type exami- nation certificate PTB 00 ATEX 1059
IECEx Certificate:	IECEx PTB 12.0056

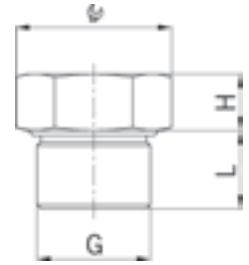

G	IC	H mm	L mm	Art.-Nr. Art. No.	
M12x1.5	15	5	15	8710.12	10
M16x1.5	18	6	15	8710.17	10
M20x1.5	24	8	15	8710.20	10
M25x1.5	30	10	15	8710.25	10
M32x1.5	36	12	15	8710.32	10
M40x1.5	46	12	15	8710.40	10
M50x1.5	55	12	15	8710.50	10
M63x1.5	70	12	15	8710.63	10

Lieferbar auf Anfrage Available on request

Verschlusschrauben Messing für hohe Temperaturen +200°C mit FPM O-Ring Locking plugs for high temperature applications +200°C with FPM O-ring



Anschlussgewinde Pg | Entry thread Pg



G	IC	H mm	L mm	Art.-Nr. Art. No.	
Pg 7	16	6.4	10.5	8710.07	10
Pg 9	18	7.5	12	8710.09	10
Pg 11	21	8.8	12	8710.11	10
Pg 13	24	10.0	14	8710.13	10
Pg 16	27	11.5	14	8710.16	10
Pg 21	32	14.0	16	8710.21	10
Pg 29	41	17.0	17	8710.29	10
Pg 36	55	22.5	17	8710.36	10

Lieferbar auf Anfrage Available on request

Verschlusschrauben Messing für hohe Temperaturen +200°C mit FPM O-Ring Locking plugs for high temperature applications +200°C with FPM O-ring



Zubehör zu Kabelverschraubungen Messing druckfeste Kapselung Ex d IIC

Accessories for cable glands nickel-plated brass for flameproof enclosure Ex d IIC

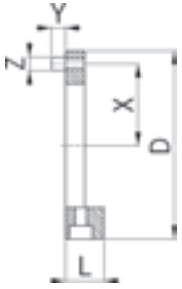

Sicherungsringe zu Kabelverschraubungen für druckfeste Kapselung Ex d IIC

Material: Messing vernickelt
 Schrauben: Rostfreier Stahl A2
 Einsatztemperatur: -60°C / +200°C
 Einsatzbereich: Zusätzlicher Schutz gegen Selbstlockerung bei Vibrationen

Locking rings suitable for cable glands for flameproof enclosure Ex d IIC

Material: Nickel-plated brass
 Screws: Stainless steel A2
 Temperature range: -60°C / +200°C
 Application: Additional safety against self-opening due to vibrations



Sicherungsring nach Schlüsselweite der Ex d IIC Kabelverschraubung bestimmen

The dimension of the locking ring has to match the wrench size of the Ex d IIC cable gland

IC	D mm	L mm	X mm	Y mm	ØZ mm	Art.-Nr. Art. No.	
20	40	13	15	5	5	1809.26.50	50
24	47	13	18	5	5	1811.26.50	50
26	50	13	20	5	5	1816.26.50	50
32	56	13	23	5	5	1821.26.50	50
36	60	13	25	5	5	1821.27.50	50
45	69	14	30	5	5	1829.26.50	50

AGRO Kabelverschraubungen Progress® Messing erhöhte Sicherheit Ex e II

AGRO cable glands Progress® nickel-plated brass increased safety Ex e II

Kurzes Anschlussgewinde metrisch | Short entry thread metric

Material: Messing vernickelt
 Dichtung: TPE
 Einsatztemperatur: -40°C / +100°C
 Schutzart: IP 68 (bis 10 bar)
 Weitere Schutzart: IP 69K
 Prüfnorm: IEC EN 60079-0 / IEC EN 60079-7
 Kategorie 2G: Ex e II
 Kategorie 2D: Ex tD A21 IP68
 Zone: Gas 1 und 2 / Staub 21 und 22
 Zertifikat: EG-Baumusterprüfbescheinigung PTB 02 ATEX 1126X
 IECEx Zertifikat: IECEx SEV 12.0002X

Material: Nickel-plated brass
 Seal: TPE
 Temperature range: -40°C / +100°C
 Protection class: IP 68 (up to 10 bar)
 Further protection: IP 69K
 Test standard: IEC EN 60079-0 / IEC EN 60079-7
 Category 2G: Ex e II
 Category 2D: Ex tD A21 IP68
 Zone: Gas 1 and 2 / dust 21 and 22
 Certificate: EC-type examination certificate PTB 02 ATEX 1126X
 IECEx Certificate: IECEx SEV 12.0002X

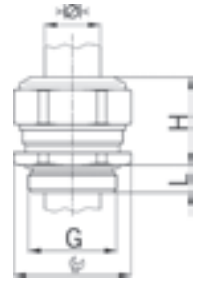

Progress MS EX



Einteiliger Dichteinsatz
 nicht durchgehend isolierend

One-piece sealing insert
 not overall length insulated

G	> Ø < min mm	> Ø < max mm	IC	H mm	L mm	i info	Art.-Nr. Art. No.	
M8x1.25	3.0	3.5	11	14	5	1	EX1000.08.035	50
M8x1.25	4.0	5.0	11	14	5	1	EX1000.08.050	50
M10x1.5	3.0	4.0	13	15	5	1	EX1000.10.040	50
M10x1.5	4.5	6.0	13	15	5	1	EX1000.10.060	50
M12x1.5	5.0	6.5	15	17	5	-	EX1000.12.065	50
M12x1.5	6.5	8.0	15	17	5	-	EX1000.12.080	50
M16x1.5	4.5	6.0	18	20	5	-	EX1000.17.060	50
M16x1.5	6.0	8.0	18	20	5	-	EX1000.17.080	50
M20x1.5	6.0	8.0	24	21	6	-	EX1000.20.080	50
M20x1.5	8.0	11.0	24	21	6	-	EX1000.20.110	50
M25x1.5	9.5	12.5	30	25	7	-	EX1000.25.125	25
M25x1.5	12.5	16.0	30	27	7	-	EX1000.25.160	25
M32x1.5	14.0	17.0	36	28	8	-	EX1000.32.170	25
M32x1.5	17.0	21.0	36	28	8	-	EX1000.32.210	25
M40x1.5	20.0	24.0	46	31	8	-	EX1000.40.240	10
M40x1.5	24.0	28.5	46	31	8	-	EX1000.40.285	10



1 = Metrisches Regelgewinde

1 = Metric coarse-pitch thread

Langes Anschlussgewinde metrisch | Long entry thread metric

Progress MS EX



Einteiliger Dichteinsatz
 nicht durchgehend isolierend

One-piece sealing insert
 not overall length insulated

G	> Ø < min mm	> Ø < max mm	IC	H mm	L mm	i info	Art.-Nr. Art. No.	
M8x1.25	3.0	3.5	11	14	10	1	EX1100.08.035	50
M8x1.25	4.0	5.0	11	14	10	1	EX1100.08.050	50
M10x1.5	3.0	4.0	13	15	10	1	EX1100.10.040	50
M10x1.5	4.5	6.0	13	15	10	1	EX1100.10.060	50
M12x1.5	5.0	6.5	15	17	10	-	EX1100.12.065	50
M12x1.5	6.5	8.0	15	17	10	-	EX1100.12.080	50
M16x1.5	4.5	6.0	18	20	10	-	EX1100.17.060	50
M16x1.5	6.0	8.0	18	20	10	-	EX1100.17.080	50
M20x1.5	6.0	8.0	24	21	10	-	EX1100.20.080	50
M20x1.5	8.0	11.0	24	21	10	-	EX1100.20.110	50
M25x1.5	9.5	12.5	30	25	11	-	EX1100.25.125	25
M25x1.5	12.5	16.0	30	27	11	-	EX1100.25.160	25
M32x1.5	14.0	17.0	36	28	13	-	EX1100.32.170	25
M32x1.5	17.0	21.0	36	28	13	-	EX1100.32.210	25
M40x1.5	20.0	24.0	46	31	13	-	EX1100.40.240	10
M40x1.5	24.0	28.5	46	31	13	-	EX1100.40.285	10



1 = Metrisches Regelgewinde

1 = Metric coarse-pitch thread

AGRO Kabelverschraubungen Progress® Messing erhöhte Sicherheit Ex e II

AGRO cable glands Progress® nickel-plated brass increased safety Ex e II

Kurzes Anschlussgewinde Pg | Short entry thread Pg

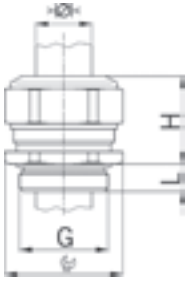

Material: Messing vernickelt
 Dichtung: TPE
 Einsatztemperatur: -40°C / +100°C
 Schutzart: IP 68 (bis 10 bar)
 Weitere Schutzart: IP 69K
 Prüfnorm: IEC EN 60079-0 / IEC EN 60079-7
 Kategorie 2G: Ex e II
 Kategorie 2D: Ex tD A21 IP68
 Zone: Gas 1 und 2 / Staub 21 und 22
 Zertifikat: EG-Baumusterprüfbescheinigung PTB 02 ATEX 1126X
 IECEx Zertifikat: IECEx SEV 12.0002X

Material: Nickel-plated brass
 Seal: TPE
 Temperature range: -40°C / +100°C
 Protection class: IP 68 (up to 10 bar)
 Further protection: IP 69K
 Test standard: IEC EN 60079-0 / IEC EN 60079-7
 Category 2G: Ex e II
 Category 2D: Ex tD A21 IP68
 Zone: Gas 1 and 2 / dust 21 and 22
 Certificate: EC-type examination certificate PTB 02 ATEX 1126X
 IECEx Certificate: IECEx SEV 12.0002X

Progress MS EX



Einteiliger Dichteinsatz
 nicht durchgehend isolierend

One-piece sealing insert
 not overall length insulated

G	> Ø < min mm	> Ø < max mm		H mm	L mm	Art.-Nr. Art. No.	
Pg 7	5.0	6.5	15	17	6	EX1000.07.065	50
Pg 7	6.5	8.0	15	17	6	EX1000.07.080	50
Pg 9	4.5	6.0	18	20	6	EX1000.09.060	50
Pg 9	6.0	8.0	18	20	6	EX1000.09.080	50
Pg 11	4.0	5.5	21	21	6	EX1000.11.055	50
Pg 11	5.5	8.5	21	21	6	EX1000.11.085	50
Pg 13	6.0	8.0	24	21	6	EX1000.13.080	50
Pg 13	8.0	11.0	24	21	6	EX1000.13.110	50
Pg 16	6.0	8.0	24	21	6	EX1000.16.080	50
Pg 16	8.0	11.0	24	21	6	EX1000.16.110	50
Pg 21	9.5	12.5	30	25	7.5	EX1000.21.125	25
Pg 21	12.5	16.0	30	25	7.5	EX1000.21.160	25
Pg 29	16.0	19.0	38	28	8	EX1000.29.190	25
Pg 29	19.0	23.0	38	28	8	EX1000.29.230	25
Pg 36	21.5	26.0	50	32	8	EX1000.36.260	10
Pg 36	26.0	30.5	50	32	8	EX1000.36.305	10

Langes Anschlussgewinde Pg | Long entry thread Pg



Progress MS EX

Einteiliger Dichteinsatz
 nicht durchgehend isolierend

One-piece sealing insert
 not overall length insulated

G	> Ø < min mm	> Ø < max mm		H mm	L mm	Art.-Nr. Art. No.	
Pg 7	5.0	6.5	15	17	10	EX1100.07.065	50
Pg 7	6.5	8.0	15	17	10	EX1100.07.080	50
Pg 9	4.5	6.0	18	20	10	EX1100.09.060	50
Pg 9	6.0	8.0	18	20	10	EX1100.09.080	50
Pg 11	4.0	5.5	21	21	10	EX1100.11.055	50
Pg 11	5.5	8.5	21	21	10	EX1100.11.085	50
Pg 13	6.0	8.0	24	21	10	EX1100.13.080	50
Pg 13	8.0	11.0	24	21	10	EX1100.13.110	50
Pg 16	6.0	8.0	24	21	10	EX1100.16.080	50
Pg 16	8.0	11.0	24	21	10	EX1100.16.110	50
Pg 21	9.5	12.5	30	25	12	EX1100.21.125	25
Pg 21	12.5	16.0	30	25	12	EX1100.21.160	25
Pg 29	16.0	19.0	38	28	12	EX1100.29.190	25
Pg 29	19.0	23.0	38	28	12	EX1100.29.230	25
Pg 36	21.5	26.0	50	32	15	EX1100.36.260	10
Pg 36	26.0	30.5	50	32	15	EX1100.36.305	10

Kurzes Anschlussgewinde metrisch | Short entry thread metric

Material: Messing vernickelt
 Dichtung: TPE / NBR
 Einsatztemperatur: -40°C / +100°C
 Schutzart: IP 68
 Prüfnorm: IEC EN 60079-0 / IEC EN 60079-7
 Kategorie 2G: Ex e II
 Kategorie 2D: Ex tD A21 IP68
 Zone: Gas 1 und 2 / Staub 21 und 22
 Zertifikat: EG-Baumusterprüfbescheinigung PTB 02 ATEX 1126X
 IECEx Zertifikat: IECEx SEV 12.0002X

Material: Nickel-plated brass
 Seal: TPE / NBR
 Temperature range: -40°C / +100°C
 Protection class: IP 68
 Test standard: IEC EN 60079-0 / IEC EN 60079-7
 Category 2G: Ex e II
 Category 2D: Ex tD A21 IP68
 Zone: Gas 1 and 2 / dust 21 and 22
 Certificate: EC-type examination certificate PTB 02 ATEX 1126X
 IECEx Certificate: IECEx SEV 12.0002X

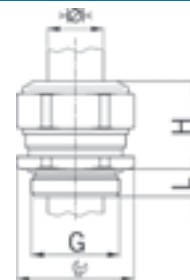

Progress MS Multi EX



Einteiliger Dichteinsatz
 nicht durchgehend isolierend

One-piece sealing insert
 not overall length insulated

G	>Ø< min mm	>Ø< max mm	⊗	⊕	H mm	L mm	i info	Art.-Nr. Art. No.	📦
M12x1.5	0.6	1.0	3	15	17	5	3	EX1310.12.3.010	50
M16x1.5	1.0	1.5	4	18	20	5	3	EX1310.17.4.015	50
M16x1.5	2.0	3.0	2	18	20	5	-	EX1310.17.2.030	50
M20x1.5	2.5	3.0	6	24	21	6	-	EX1310.20.6.030	50
M20x1.5	3.5	5.0	2	24	21	6	-	EX1310.20.2.050	50
M20x1.5	3.5	5.0	4	24	21	6	-	EX1310.20.4.050	50
M20x1.5	4.5	6.0	3	24	21	6	-	EX1310.20.3.060	50
M20x1.5	5.5	7.5	2	24	21	6	-	EX1310.20.2.075	50
M25x1.5	5.0	6.0	6	30	25	7	-	EX1310.25.6.060	25
M25x1.5	6.0	7.0	3	30	25	7	-	EX1310.25.3.070	25
M25x1.5	5.5	7.0	4	30	25	7	-	EX1310.25.4.070	25
M25x1.5	7.5	9.0	3	30	25	7	-	EX1310.25.3.090	25
M25x1.5	8.0	10.0	2	30	25	7	-	EX1310.25.2.100	25
M32x1.5	6.0	7.0	6	36	28	8	-	EX1310.32.6.070	25
M32x1.5	7.5	9.0	4	36	28	8	-	EX1310.32.4.090	25
M40x1.5	8.0	9.0	7	46	31	8	3	EX1310.40.7.090	10
M40x1.5	14.0	15.0	2	46	31	8	3	EX1310.40.2.150	10
M50x1.5	9.0	10.0	4	55	34	9	3	EX1310.50.4.100	10
M63x1.5	11.0	12.0	6	70	37	10	3	EX1310.63.6.120	5
M63x1.5	17.0	18.0	3	70	37	10	3	EX1310.63.3.180	5

3 = Material Dichteinsatz NBR

3 = Material sealing insert NBR



Kurzes Anschlussgewinde Pg | Short entry thread Pg

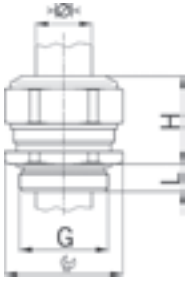

Material: Messing vernickelt
 Dichtung: TPE / NBR
 Einsatztemperatur: -40°C / +100°C
 Schutzart: IP 68
 Prüfnorm: IEC EN 60079-0 / IEC EN 60079-7
 Kategorie 2G: Ex e II
 Kategorie 2D: Ex tD A21 IP68
 Zone: Gas 1 und 2 / Staub 21 und 22
 Zertifikat: EG-Baumusterprüfbescheinigung PTB 02 ATEX 1126X
 IECEx Zertifikat: IECEx SEV 12.0002X

Material: Nickel-plated brass
 Seal: TPE / NBR
 Temperature range: -40°C / +100°C
 Protection class: IP 68
 Test standard: IEC EN 60079-0 / IEC EN 60079-7
 Category 2G: Ex e II
 Category 2D: Ex tD A21 IP68
 Zone: Gas 1 and 2 / dust 21 and 22
 Certificate: EC-type examination certificate PTB 02 ATEX 1126X
 IECEx Certificate: IECEx SEV 12.0002X

Progress MS Multi EX



Einteiliger Dichteinsatz
 nicht durchgehend isolierend

One-piece sealing insert
 not overall length insulated

G	> Ø < min mm	> Ø < max mm	⊗	Ⓜ	H mm	L mm	i info	Art.-Nr. Art. No.	📦
Pg 9	1.0	1.5	4	18	20	6	3	EX1310.09.4.015	50
Pg 9	2.0	3.0	2	18	20	6	-	EX1310.09.2.030	50
Pg 11	2.0	3.0	3	21	21	6	3	EX1310.11.3.030	50
Pg 11	3.0	4.0	2	21	21	6	3	EX1310.11.2.040	50
Pg 11	3.5	5.0	2	21	21	6	-	EX1310.11.2.050	50
Pg 13	2.5	4.0	3	24	23	6	3	EX1310.13.3.040	50
Pg 13	3.5	5.0	2	24	23	6	-	EX1310.13.2.050	50
Pg 16	2.5	3.0	6	24	23	6	-	EX1310.16.6.030	50
Pg 16	3.0	4.0	6	24	23	6	3	EX1310.16.6.040	50
Pg 16	4.5	6.0	2	24	23	6	-	EX1310.16.2.060	50
Pg 16	4.5	6.0	3	24	23	6	-	EX1310.16.3.060	50
Pg 21	5.5	7.0	4	30	28	7	-	EX1310.21.4.070	25
Pg 21	7.5	9.0	3	30	28	7	-	EX1310.21.3.090	25
Pg 29	5.5	6.5	6	38	28	8	3	EX1310.29.6.065	25
Pg 29	8.0	9.0	3	38	28	8	3	EX1310.29.3.090	25
Pg 36	9.0	10.0	4	50	32	8	3	EX1310.36.4.100	10
Pg 36	14.0	15.0	2	50	32	8	3	EX1310.36.2.150	10
Pg 48	11.0	12.0	6	65	37	11	3	EX1310.48.6.120	10
Pg 48	17.0	18.0	3	65	37	11	3	EX1310.48.3.180	10

3 = Material Dichteinsatz NBR

3 = Material sealing insert NBR

Kurzes Anschlussgewinde metrisch | Short entry thread metric

Material: Messing vernickelt
 Schrauben: Rostfreier Stahl A2
 Dichtung: TPE
 Einsatztemperatur: -40°C / +100°C
 Schutzart: IP 68 (bis 10 bar)
 Weitere Schutzart: IP 69K
 Prüfnorm: IEC EN 60079-0 / IEC EN 60079-7
 Kategorie 2G: Ex e II
 Kategorie 2D: Ex tD A21 IP68
 Zone: Gas 1 und 2 / Staub 21 und 22
 Zertifikat: EG-Baumusterprüfbescheinigung PTB 02 ATEX 1125
 IECEx Zertifikat: IECEx SEV 12.0001

Material: Nickel-plated brass
 Screws: Stainless steel A2
 Seal: TPE
 Temperature range: -40°C / +100°C
 Protection class: IP 68 (up to 10 bar)
 Further protection: IP 69K
 Test standard: IEC EN 60079-0 / IEC EN 60079-7
 Kategorie 2G: Ex e II
 Kategorie 2D: Ex tD A21 IP68
 Zone: Gas 1 and 2 / dust 21 and 22
 Certificate: EC-type test certificate PTB 02 ATEX 1125
 IECEx Certificate: IECEx SEV 12.0001

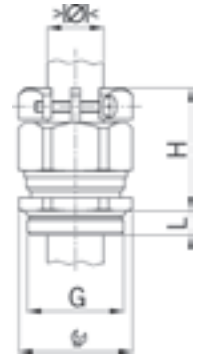

Progress MS KB EX



Einteiliger Dichteinsatz
 nicht durchgehend isolierend

One-piece sealing insert
 not overall length insulated

G	> Ø < min mm	> Ø < max mm		H mm	L mm	i info	Art.-Nr. Art. No.	
M12x1.5	5.0	6.5	15/16	26	5	2	EX1803.12.03.065	50
M12x1.5	6.5	8.0	15/16	26	5	2	EX1803.12.03.080	50



2 = Zertifikat PTB 02 ATEX 1126X / IECEx SEV 12.0002X

2 = Certificate PTB 02 ATEX 1126X / IECEx SEV 12.0002X

Folgende EX-Kabelverschraubungen mit Klemmbacken Ex e II sind auf Anfrage erhältlich:

The following cable glands with clamps Ex e II are available on request:

- Kabelverschraubungen Messing mit langem Anschlussgewinde
- Kabelverschraubungen Messing mit hochtemperaturbeständigem FPM-Dichteinsatz (+200°C)
- Kabelverschraubungen aus rostfreiem Stahl A2 mit langem Anschlussgewinde
- Kabelverschraubungen aus rostfreiem Stahl A2 oder rostfreiem und säurebeständigem Stahl A4 mit langem Anschlussgewinde und hochtemperaturbeständigem FPM-Dichteinsatz (+200°C)

- Cable glands nickel-plated brass with long entry thread
- Cable glands nickel-plated brass with FPM sealing insert for high temperature applications (+200°C)
- Cable glands stainless steel A2 with long entry thread
- Cable glands stainless steel A2 or stainless and acid resistant steel A4 with long entry thread and FPM sealing insert for high temperature applications (+200°C)

Progress MS KB EX



Zweiteiliger Dichteinsatz
 nicht durchgehend isolierend

Two-piece sealing insert
 not overall length insulated

G	> Ø < min mm	> Ø < max mm		H mm	L mm	i info	Art.-Nr. Art. No.	
M16x1.5	6.0	10.5	18/19	30	5	-	EX1803.17	50
M20x1.5	8.0	15.0	24	31	6	-	EX1803.20	50
M25x1.5	12.5	20.5	30	35	7	-	EX1803.25	25
M32x1.5	17.0	25.5	36	40	8	-	EX1803.32	25
M40x1.5	24.0	33.0	46	44	8	-	EX1803.40	10
M50x1.5	33.0	42.0	55	49	9	-	EX1803.50	10
M63x1.5	40.0	52.0	70	55	10	-	EX1803.63	5



Folgende EX-Kabelverschraubungen mit Klemmbacken Ex e II sind auf Anfrage erhältlich:

The following cable glands with clamps Ex e II are available on request:

- Kabelverschraubungen Messing mit langem Anschlussgewinde
- Kabelverschraubungen Messing mit hochtemperaturbeständigem FPM-Dichteinsatz (+200°C)
- Kabelverschraubungen aus rostfreiem Stahl A2 mit langem Anschlussgewinde
- Kabelverschraubungen aus rostfreiem Stahl A2 oder rostfreiem und säurebeständigem Stahl A4 mit langem Anschlussgewinde und hochtemperaturbeständigem FPM-Dichteinsatz (+200°C)

- Cable glands nickel-plated brass with long entry thread
- Cable glands nickel-plated brass with FPM sealing insert for high temperature applications (+200°C)
- Cable glands stainless steel A2 with long entry thread
- Cable glands stainless steel A2 or stainless and acid resistant steel A4 with long entry thread and FPM sealing insert for high temperature applications (+200°C)

Kurzes Anschlussgewinde Pg | Short entry thread Pg

Material:	Messing vernickelt	Material:	Nickel-plated brass
Schrauben:	Rostfreier Stahl A2	Screws:	Stainless steel A2
Dichtung:	TPE	Seal:	TPE
Einsatztemperatur:	-40°C / +100°C	Temperature range:	-40°C / +100°C
Schutzart:	IP 68 (bis 10 bar)	Protection class:	IP 68 (up to 10 bar)
Weitere Schutzart:	IP 69K	Further protection:	IP 69K
Prüfnorm:	IEC EN 60079-0 / IEC EN 60079-7	Test standard:	IEC EN 60079-0 / IEC EN 60079-7
Kategorie 2G:	Ex e II	Category 2G:	Ex e II
Kategorie 2D:	Ex tD A21 IP68	Category 2D:	Ex tD A21 IP68
Zone:	Gas 1 und 2 / Staub 21 und 22	Zone:	Gas 1 and 2 / dust 21 and 22
Zertifikat:	EG-Baumuster- prüfbescheinigung PTB 02 ATEX 1125	Certificate:	EC-type test certificate PTB 02 ATEX 1125
IECEX Zertifikat:	IECEX SEV 12.0001	IECEX Certificate:	IECEX SEV 12.0001



Progress MS KB EX



Einteiliger Dichteinsatz
nicht durchgehend isolierend

One-piece sealing insert
not overall length insulated

G	>Ø< min mm	>Ø< max mm		H mm	L mm	i info	Art.-Nr. Art. No.	
Pg 7	5.0	6.5	15/16	26	6	2	EX1803.07.03.065	50
Pg 7	6.5	8.0	15/16	26	6	2	EX1803.07.03.080	50

2 = Zertifikat PTB 02 ATEX 1126X / IECEx SEV 12.0002X

2 = Certificate PTB 02 ATEX 1126X / IECEx SEV 12.0002X

Folgende EX-Kabelverschraubungen mit Klemmbacken Ex e II sind auf Anfrage erhältlich:

The following cable glands with clamps Ex e II are available on request:

- Kabelverschraubungen Messing mit langem Anschlussgewinde
- Kabelverschraubungen Messing mit hochtemperaturbeständigem FPM-Dichteinsatz (+200°C)
- Kabelverschraubungen aus rostfreiem Stahl A2 mit langem Anschlussgewinde
- Kabelverschraubungen aus rostfreiem Stahl A2 oder rostfreiem und säurebeständigem Stahl A4 mit langem Anschlussgewinde und hochtemperaturbeständigem FPM-Dichteinsatz (+200°C)

- Cable glands nickel-plated brass with long entry thread
- Cable glands nickel-plated brass with FPM sealing insert for high temperature applications (+200°C)
- Cable glands stainless steel A2 with long entry thread
- Cable glands stainless steel A2 or stainless and acid resistant steel A4 with long entry thread and FPM sealing insert for high temperature applications (+200°C)

Kurzes Anschlussgewinde Pg | Short entry thread Pg

Material: Messing vernickelt
 Schrauben: Rostfreier Stahl A2
 Dichtung: TPE
 Einsatztemperatur: -40°C / +100°C
 Schutzart: IP 68 (bis 10 bar)
 Weitere Schutzart: IP 69K
 Prüfnorm: IEC EN 60079-0 / IEC EN 60079-7
 Kategorie 2G: Ex e II
 Kategorie 2D: Ex tD A21 IP68
 Zone: Gas 1 und 2 / Staub 21 und 22
 Zertifikat: EG-Baumusterprüfbescheinigung PTB 02 ATEX 1125
 IECEx Zertifikat: IECEx SEV 12.0001

Material: Nickel-plated brass
 Screws: Stainless steel A2
 Seal: TPE
 Temperature range: -40°C / +100°C
 Protection class: IP 68 (up to 10 bar)
 Further protection: IP 69K
 Test standard: IEC EN 60079-0 / IEC EN 60079-7
 Kategorie 2G: Ex e II
 Kategorie 2D: Ex tD A21 IP68
 Zone: Gas 1 and 2 / dust 21 and 22
 Certificate: EC-type test certificate PTB 02 ATEX 1125
 IECEx Certificate: IECEx SEV 12.0001

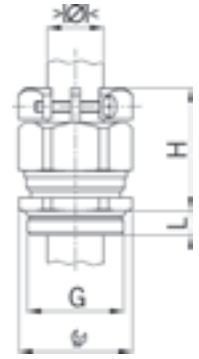

Progress MS KB EX



Zweiteiliger Dichteinsatz
 nicht durchgehend isolierend

Two-piece sealing insert
 not overall length insulated

G	> Ø < min mm	> Ø < max mm		H mm	L mm	i info	Art.-Nr. Art. No.	
Pg 9	6.0	10.5	18/19	30	6	-	EX1803.09	50
Pg 11	5.5	12.0	21	31	6	-	EX1803.11	50
Pg 13	8.0	15.0	24	31	6	-	EX1803.13	50
Pg 16	8.0	15.0	24	31	6	-	EX1803.16	50
Pg 21	12.5	20.5	30	35	7.5	-	EX1803.21	25
Pg 29	19.0	27.5	38	40	8	-	EX1803.29	25
Pg 36	26.0	35.0	50	47	8	-	EX1803.36	10
Pg 42	33.0	42.0	55	49	10	-	EX1803.42	10
Pg 48	37.0	49.0	65	51	11	-	EX1803.48	5



Folgende EX-Kabelverschraubungen mit Klemmbucken Ex e II sind auf Anfrage erhältlich:

The following cable glands with clamps Ex e II are available on request:

- Kabelverschraubungen Messing mit langem Anschlussgewinde
- Kabelverschraubungen Messing mit hochtemperaturbeständigem FPM-Dichteinsatz (+200°C)
- Kabelverschraubungen aus rostfreiem Stahl A2 mit langem Anschlussgewinde
- Kabelverschraubungen aus rostfreiem Stahl A2 oder rostfreiem und säurebeständigem Stahl A4 mit langem Anschlussgewinde und hochtemperaturbeständigem FPM-Dichteinsatz (+200°C)
- Cable glands nickel-plated brass with long entry thread
- Cable glands nickel-plated brass with FPM sealing insert for high temperature applications (+200°C)
- Cable glands stainless steel A2 with long entry thread
- Cable glands stainless steel A2 or stainless and acid resistant steel A4 with long entry thread and FPM sealing insert for high temperature applications (+200°C)

Kurzes Anschlussgewinde metrisch | Short entry thread metric

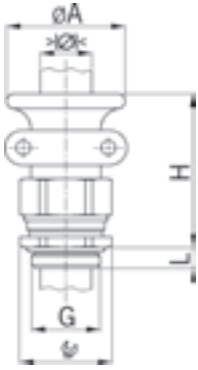

Material: Messing vernickelt
 Schrauben: Rostfreier Stahl A2
 Dichtung: TPE
 Einsatztemperatur: -40°C / +100°C
 Schutzart: IP 68 (bis 10 bar)
 Weitere Schutzart: IP 69K
 Prüfnorm: IEC EN 60079-0 / IEC EN 60079-7
 Kategorie 2G: Ex e II
 Kategorie 2D: Ex tD A21 IP68
 Zone: Gas 1 und 2 / Staub 21 und 22
 Zertifikat: EG-Baumuster-prüfbescheinigung PTB 02 ATEX 1125
 IECEx Zertifikat: IECEx SEV 12.0001

Material: Nickel-plated brass
 Screws: Stainless steel A2
 Seal: TPE
 Temperature range: -40°C / +100°C
 Protection class: IP 68 (up to 10 bar)
 Further protection: IP 69K
 Test standard: IEC EN 60079-0 / IEC EN 60079-7
 Category 2G: Ex e II
 Category 2D: Ex tD A21 IP68
 Zone: Gas 1 and 2 / dust 21 and 22
 Certificate: EC-type test certificate PTB 02 ATEX 1125
 IECEx Certificate: IECEx SEV 12.0001

Progress MS T+KB EX



Zweiteiliger Dichteinsatz
 nicht durchgehend isolierend

Two-piece sealing insert
 not overall length insulated

G	> Ø < min mm	> Ø < max mm	IC	ØA mm	H mm	L mm	Art.-Nr. Art. No.	
M16x1.5	6.0	10.5	18	28	43	5	EX1801.17	50
M20x1.5	8.0	15.0	24	34	46	6	EX1801.20	50
M25x1.5	12.5	20.5	30	44	52	7	EX1801.25	25
M32x1.5	17.0	25.5	36	50	59	8	EX1801.32	10
M40x1.5	24.0	33.0	46	57	59	8	EX1801.40	5

Auf Anfrage lieferbar:

- Kabelverschraubungen Messing mit Trompete und Klemmbacken und hochtemperaturbeständigem FPM-Dichteinsatz (+200°C)

Available on request:

- Cable glands nickel-plated brass with trumpet and clamps, with FPM sealing insert for high temperature applications (+200°C)

Langes Anschlussgewinde metrisch | Long entry thread metric

Progress MS T+KB EX



Zweiteiliger Dichteinsatz
 nicht durchgehend isolierend

Two-piece sealing insert
 not overall length insulated

G	> Ø < min mm	> Ø < max mm	IC	ØA mm	H mm	L mm	Art.-Nr. Art. No.	
M16x1.5	6.0	10.5	18	28	43	10	EX1811.17	50
M20x1.5	8.0	15.0	24	34	46	10	EX1811.20	50
M25x1.5	12.5	20.5	30	44	52	11	EX1811.25	25
M32x1.5	17.0	25.5	36	50	59	13	EX1811.32	10
M40x1.5	24.0	33.0	46	57	59	13	EX1811.40	5

Auf Anfrage lieferbar:

- Kabelverschraubungen Messing mit Trompete und Klemmbacken und hochtemperaturbeständigem FPM-Dichteinsatz (+200°C)

Available on request:

- Cable glands nickel-plated brass with trumpet and clamps, with FPM sealing insert for high temperature applications (+200°C)

Kurzes Anschlussgewinde Pg | Short entry thread Pg

Material: Messing vernickelt
 Schrauben: Rostfreier Stahl A2
 Dichtung: TPE
 Einsatztemperatur: -40°C / +100°C
 Schutzart: IP 68 (bis 10 bar)
 Weitere Schutzart: IP 69K
 Prüfnorm: IEC EN 60079-0 / IEC EN 60079-7
 Kategorie 2G: Ex e II
 Kategorie 2D: Ex tD A21 IP68
 Zone: Gas 1 und 2 / Staub 21 und 22
 Zertifikat: EG-Baumusterprüfbescheinigung PTB 02 ATEX 1125
 IECEx Zertifikat: IECEx SEV 12.0001

Material: Nickel-plated brass
 Screws: Stainless steel A2
 Seal: TPE
 Temperature range: -40°C / +100°C
 Protection class: IP 68 (up to 10 bar)
 Further protection: IP 69K
 Test standard: IEC EN 60079-0 / IEC EN 60079-7
 Kategorie 2G: Ex e II
 Kategorie 2D: Ex tD A21 IP68
 Zone: Gas 1 and 2 / dust 21 and 22
 Certificate: EC-type test certificate PTB 02 ATEX 1125
 IECEx Certificate: IECEx SEV 12.0001

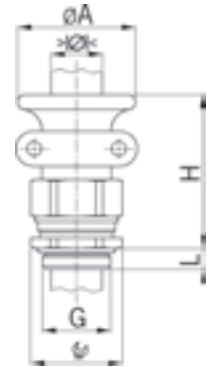

Progress MS T+KB EX



Zweiteiliger Dichteinsatz nicht durchgehend isolierend

Two-piece sealing insert not overall length insulated

G	> Ø < min mm	> Ø < max mm		ØA mm	H mm	L mm	Art.-Nr. Art. No.	
Pg 9	6.0	10.5	18	28	43	6	EX1801.09	50
Pg 11	5.5	12.0	21	30	43	6	EX1801.11	50
Pg 13	8.0	15.0	24	34	46	6	EX1801.13	50
Pg 16	8.0	15.0	24	34	46	6	EX1801.16	50
Pg 21	12.5	20.5	30	44	52	7.5	EX1801.21	25
Pg 29	19.0	27.5	38	50	59	8	EX1801.29	10



Auf Anfrage lieferbar:

Available on request:

- Kabelverschraubungen Messing mit Trompete und Klemmbacken und hochtemperaturbeständigem FPM-Dichteinsatz (+200°C)

- Cable glands nickel-plated brass with trumpet and clamps, with FPM sealing insert for high temperature applications (+200°C)

Langes Anschlussgewinde Pg | Long entry thread Pg

Progress MS T+KB EX



Zweiteiliger Dichteinsatz nicht durchgehend isolierend

Two-piece sealing insert not overall length insulated

G	> Ø < min mm	> Ø < max mm		ØA mm	H mm	L mm	Art.-Nr. Art. No.	
Pg 9	6.0	10.5	18	28	43	10	EX1811.09	50
Pg 11	5.5	12.0	21	30	43	10	EX1811.11	50
Pg 13	8.0	15.0	24	34	46	10	EX1811.13	50
Pg 16	8.0	15.0	24	34	46	10	EX1811.16	50
Pg 21	12.5	20.5	30	44	52	12	EX1811.21	25
Pg 29	19.0	27.5	38	50	59	12	EX1811.29	10



Auf Anfrage lieferbar:

Available on request:

- Kabelverschraubungen Messing mit Trompete und Klemmbacken und hochtemperaturbeständigem FPM-Dichteinsatz (+200°C)

- Cable glands nickel-plated brass with trumpet and clamps, with FPM sealing insert for high temperature applications (+200°C)

Kurzes Anschlussgewinde metrisch | Short entry thread metric

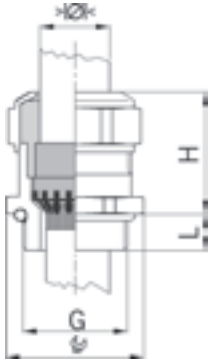

Material: Messing vernickelt
 Dichtung: TPE
 O-Ring : NBR
 Einsatztemperatur: -40°C / +100°C
 Schutzart: IP 68 (bis 10 bar)
 Weitere Schutzart: IP 69K
 Prüfnorm: IEC EN 60079-0 / IEC EN 60079-7
 Kategorie 2G: Ex e II
 Kategorie 2D: Ex tD A21 IP68
 Zone: Gas 1 und 2 / Staub 21 und 22
 Zertifikat: EG-Baumusterprüfbescheinigung PTB 02 ATEX 1126X
 IECEx Zertifikat: IECEx SEV 12.0002X
 Eigenschaften: Für zeitsparende Montage von partiell abisolierten sowie durchgehend geschirmten Kabeln

Material: Nickel-plated brass
 Seal: TPE
 O-ring : NBR
 Temperature range: -40°C / +100°C
 Protection class: IP 68 (up to 10 bar)
 Further protection: IP 69K
 Test standard: IEC EN 60079-0 / IEC EN 60079-7
 Category 2G: Ex e II
 Category 2D: Ex tD A21 IP68
 Zone: Gas 1 and 2 / dust 21 and 22
 Certificate: EC-type examination certificate PTB 02 ATEX 1126X
 IECEx Certificate: IECEx SEV 12.0002X
 Properties: For a quick installation of partially dismantled cables as well as thoroughly shielded cables

Progress MS EMC Rapid EX



Einteiliger Dichteinsatz
 nicht durchgehend isolierend

One-piece sealing insert
 not overall length insulated

G	> Ø < min mm	> Ø < max mm		H mm	L mm	Art.-Nr. Art. No.	
M12x1.5	4.5	6.0	15	20	5	EX1081.12.060	50
M12x1.5	6.0	7.5	15	20	5	EX1081.12.075	50
M16x1.5	6.0	8.0	18	23	5	EX1081.17.080	50
M16x1.5	8.0	10.0	18	25	5	EX1081.17.100	50
M20x1.5	8.0	11.0	24	25	6	EX1081.20.110	50
M20x1.5	11.0	14.0	24	27	6	EX1081.20.140	50
M25x1.5	13.0	16.0	30	30	7	EX1081.25.160	25
M25x1.5	16.0	19.0	30	33	7	EX1081.25.190	25
M32x1.5	18.0	21.0	36	32	8	EX1081.32.210	25

Langes Anschlussgewinde auf Anfrage

Long entry thread available on request

Kurzes Anschlussgewinde Pg | Short entry thread Pg

Progress MS EMC Rapid EX



Einteiliger Dichteinsatz
 nicht durchgehend isolierend

One-piece sealing insert
 not overall length insulated

G	> Ø < min mm	> Ø < max mm		H mm	L mm	Art.-Nr. Art. No.	
Pg 7	4.5	6.0	15	20	6	EX1081.07.060	50
Pg 7	6.0	7.5	15	20	6	EX1081.07.075	50
Pg 9	6.0	8.0	18	23	6	EX1081.09.080	50
Pg 9	8.0	10.0	18	25	6	EX1081.09.100	50
Pg 11	5.5	8.5	21	25	6	EX1081.11.085	50
Pg 11	8.5	12.0	21	25	6	EX1081.11.120	50
Pg 13	8.0	11.0	24	25	6	EX1081.13.110	50
Pg 13	12.5	14.0	24	27	6	EX1081.13.140	50
Pg 16	8.0	11.0	24	24	6	EX1081.16.110	50
Pg 16	12.5	14.0	24	27	6	EX1081.16.140	50
Pg 21	13.0	16.0	30	30	7	EX1081.21.160	25
Pg 21	17.0	19.0	30	33	7	EX1081.21.190	25
Pg 29	19.0	23.0	38	33	8	EX1081.29.230	25
Pg 29	23.0	25.5	38	32	8	EX1081.29.255	25

Langes Anschlussgewinde auf Anfrage

Long entry thread available on request

Kurzes Anschlussgewinde metrisch | Short entry thread metric

Material: Messing vernickelt
 Dichtung: TPE
 O-Ring : NBR
 Einsatztemperatur: -40°C / +100°C
 Schutzart: IP 68 (bis 10 bar)
 Weitere Schutzart: IP 69K
 Prüfnorm: IEC EN 60079-0 / IEC EN 60079-7
 Kategorie 2G: Ex e II
 Kategorie 2D: Ex tD A21 IP68
 Zone: Gas 1 und 2 / Staub 21 und 22
 Zertifikat: EG-Baumusterprüfbescheinigung PTB 02 ATEX 1126X
 IECEx Zertifikat: IECEx SEV 12.0002X
 Eigenschaften: Sehr guter Schirmkontakt über die Kontakthülse bei in der Kabelverschraubung endendem Schirmgeflecht

Material: Nickel-plated brass
 Seal: TPE
 O-ring : NBR
 Temperature range: -40°C / +100°C
 Protection class: IP 68 (up to 10 bar)
 Further protection: IP 69K
 Test standard: IEC EN 60079-0 / IEC EN 60079-7
 Kategorie 2G: Ex e II
 Kategorie 2D: Ex tD A21 IP68
 Zone: Gas 1 and 2 / dust 21 and 22
 Certificate: EC-type examination certificate PTB 02 ATEX 1126X
 IECEx Certificate: IECEx SEV 12.0002X
 Properties: Excellent shield contact through the contact sleeve with the braided shield terminating in the screwed cable gland

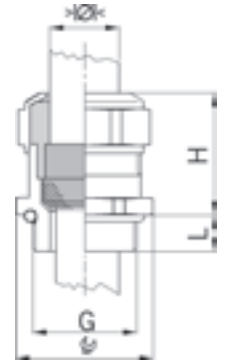

Progress MS EMC EX



Einteiliger Dichteinsatz
 nicht durchgehend isolierend

One-piece sealing insert
 not overall length insulated

G	> Ø < min mm	> Ø < max mm	IP	H mm	L mm	i info	Art.-Nr. Art. No.	
M8x1.25	2.5	3.5	11	15	5	1	EX1080.08.035	50
M8x1.25	3.0	4.0	11	15	5	1	EX1080.08.040	50
M10x1.5	3.0	4.0	13	16	5	1	EX1080.10.040	50
M10x1.5	4.0	6.0	13	16	5	1	EX1080.10.060	50
M12x1.5	4.5	6.0	15	20	5	-	EX1080.12.060	50
M12x1.5	6.0	7.5	15	20	5	-	EX1080.12.075	50
M16x1.5	6.0	8.0	18	23	5	-	EX1080.17.080	50
M16x1.5	8.0	10.0	18	25	5	-	EX1080.17.100	50
M20x1.5	8.0	11.0	24	25	6	-	EX1080.20.110	50
M20x1.5	12.5	14.0	24	27	6	-	EX1080.20.140	50
M25x1.5	13.0	16.0	30	30	7	-	EX1080.25.160	25
M25x1.5	17.0	19.0	30	33	7	-	EX1080.25.190	25
M32x1.5	17.0	21.0	36	32	8	-	EX1080.32.210	25
M40x1.5	24.0	28.5	46	34	8	-	EX1080.40.285	10



1 = Metrisches Regelgewinde

1 = Metric coarse-pitch thread

Langes Anschlussgewinde auf Anfrage

Long entry thread available on request

Kurzes Anschlussgewinde Pg | Short entry thread Pg

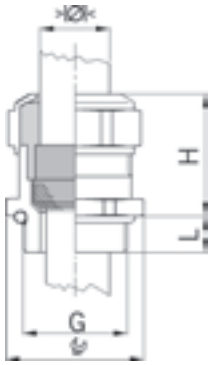

Material:	Messing vernickelt	Material:	Nickel-plated brass
Dichtung:	TPE	Seal:	TPE
O-Ring :	NBR	O-ring :	NBR
Einsatztemperatur:	-40°C / +100°C	Temperature range:	-40°C / +100°C
Schutzart:	IP 68 (bis 10 bar)	Protection class:	IP 68 (up to 10 bar)
Weitere Schutzart:	IP 69K	Further protection:	IP 69K
Prüfnorm:	IEC EN 60079-0 / IEC EN 60079-7	Test standard:	IEC EN 60079-0 / IEC EN 60079-7
Kategorie 2G:	Ex e II	Category 2G:	Ex e II
Kategorie 2D:	Ex tD A21 IP68	Category 2D:	Ex tD A21 IP68
Zone:	Gas 1 und 2 / Staub 21 und 22	Zone:	Gas 1 and 2 / dust 21 and 22
Zertifikat:	EG-Baumusterprüfbescheinigung PTB 02 ATEX 1126X	Certificate:	EC-type examination certificate PTB 02 ATEX 1126X
IECEX Zertifikat:	IECEX SEV 12.0002X	IECEX Certificate:	IECEX SEV 12.0002X
Eigenschaften:	Sehr guter Schirmkontakt über die Kontakthülse bei in der Kabelverschraubung endendem Schirmgeflecht	Properties:	Excellent shield contact through the contact sleeve with the braided shield terminating in the screwed cable gland



Progress MS EMC EX



Einteiliger Dichteinsatz nicht durchgehend isolierend		One-piece sealing insert not overall length insulated				Art.-Nr. Art. No.	
G	>Ø< min mm	>Ø< max mm		H mm	L mm		
Pg 7	4.5	6.0	15	20	6	EX1080.07.060	50
Pg 7	6.0	7.5	15	20	6	EX1080.07.075	50
Pg 9	6.0	8.0	18	23	6	EX1080.09.080	50
Pg 9	8.0	10.0	18	25	6	EX1080.09.100	50
Pg 11	5.5	8.5	21	23	6	EX1080.11.085	50
Pg 11	9.5	12.0	21	23	6	EX1080.11.120	50
Pg 13	8.0	11.0	24	25	6	EX1080.13.110	50
Pg 13	12.5	14.0	24	27	6	EX1080.13.140	50
Pg 16	8.0	11.0	24	24	6	EX1080.16.110	50
Pg 16	12.5	14.0	24	27	6	EX1080.16.140	50
Pg 21	13.0	16.0	30	30	7.5	EX1080.21.160	25
Pg 21	17.0	19.0	30	33	7.5	EX1080.21.190	25
Pg 29	19.0	23.0	38	33	8	EX1080.29.230	25
Pg 29	24.0	25.5	38	32	8	EX1080.29.255	25
Pg 36	25.0	30.5	50	36	8	EX1080.36.305	10

Langes Anschlussgewinde auf Anfrage

Long entry thread available on request

Kurzes Anschlussgewinde metrisch | Short entry thread metric

Material: Messing vernickelt
 Schrauben: Rostfreier Stahl A2
 Dichtung: TPE
 Einsatztemperatur: -40°C / +100°C
 Schutzart: IP 68 (bis 10 bar)
 Weitere Schutzart: IP 69K
 Prüfnorm: IEC EN 60079-0 / IEC EN 60079-7
 Kategorie 2G: Ex e II
 Kategorie 2D: Ex tD A21 IP68
 Zone: Gas 1 und 2 / Staub 21 und 22
 Zertifikat: EG-Baumusterprüfbescheinigung PTB 02 ATEX 1125
 IECEx Zertifikat: IECEx SEV 12.0001

Material: Nickel-plated brass
 Screws: Stainless steel A2
 Seal: TPE
 Temperature range: -40°C / +100°C
 Protection class: IP 68 (up to 10 bar)
 Further protection: IP 69K
 Test standard: IEC EN 60079-0 / IEC EN 60079-7
 Kategorie 2G: Ex e II
 Kategorie 2D: Ex tD A21 IP68
 Zone: Gas 1 and 2 / dust 21 and 22
 Certificate: EC-type test certificate PTB 02 ATEX 1125
 IECEx Certificate: IECEx SEV 12.0001

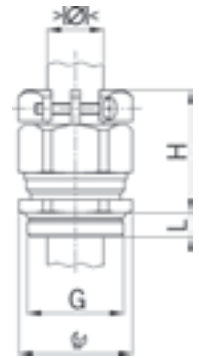

Progress MS EMC KB EX



Einteiliger Dichteinsatz
 nicht durchgehend isolierend

One-piece sealing insert
 not overall length insulated

G	> Ø < min mm	> Ø < max mm		H mm	L mm	i info	Art.-Nr. Art. No.	
M12x1.5	4.5	6.0	15/16	26	5	1	EX1803.80.12.060	50
M12x1.5	6.0	7.5	15/16	26	5	1	EX1803.80.12.075	50
M16x1.5	6.0	8.0	18/19	30	5	-	EX1803.80.17.080	50
M16x1.5	8.0	10.0	18/19	30	5	-	EX1803.80.17.100	50
M20x1.5	8.0	11.0	24	31	6	-	EX1803.80.20.110	50
M20x1.5	11.0	14.0	24	31	6	-	EX1803.80.20.140	50
M25x1.5	13.0	16.0	30	35	7	-	EX1803.80.25.160	25
M25x1.5	16.0	19.0	30	35	7	-	EX1803.80.25.190	25
M32x1.5	18.0	21.0	36	40	8	-	EX1803.80.32.210	25
M32x1.5	21.0	25.0	36	40	8	-	EX1803.80.32.250	25
M40x1.5	24.0	28.5	46	44	8	-	EX1803.80.40.285	10
M40x1.5	28.5	32.0	46	44	8	-	EX1803.80.40.320	10
M50x1.5	33.0	37.0	55	49	9	-	EX1803.80.50.370	10
M50x1.5	37.0	41.0	55	49	9	-	EX1803.80.50.410	10
M63x1.5	40.0	46.0	70	55	10	-	EX1803.80.63.460	5
M63x1.5	46.0	50.0	70	55	10	-	EX1803.80.63.500	5



1 = Zertifikat PTB 02 ATEX 1126X / IECEx SEV 12.0002X

1 = Certificate PTB 02 ATEX 1126X / IECEx SEV 12.0002X

Langes Anschlussgewinde auf Anfrage

Long entry thread available on request

Kurzes Anschlussgewinde Pg | Short entry thread Pg

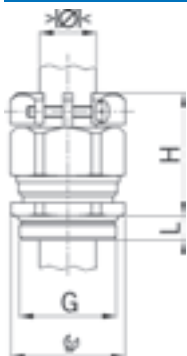

Material: Messing vernickelt
 Schrauben: Rostfreier Stahl A2
 Dichtung: TPE
 Einsatztemperatur: -40°C / +100°C
 Schutzart: IP 68 (bis 10 bar)
 Weitere Schutzart: IP 69K
 Prüfnorm: IEC EN 60079-0 / IEC EN 60079-7
 Kategorie 2G: Ex e II
 Kategorie 2D: Ex tD A21 IP68
 Zone: Gas 1 und 2 / Staub 21 und 22
 Zertifikat: EG-Baumusterprüfbescheinigung PTB 02 ATEX 1125
 IECEx Zertifikat: IECEx SEV 12.0001

Material: Nickel-plated brass
 Screws: Stainless steel A2
 Seal: TPE
 Temperature range: -40°C / +100°C
 Protection class: IP 68 (up to 10 bar)
 Further protection: IP 69K
 Test standard: IEC EN 60079-0 / IEC EN 60079-7
 Kategorie 2G: Ex e II
 Kategorie 2D: Ex tD A21 IP68
 Zone: Gas 1 and 2 / dust 21 and 22
 Certificate: EC-type test certificate PTB 02 ATEX 1125
 IECEx Certificate: IECEx SEV 12.0001

Progress MS EMC KB EX



Einteiliger Dichteinsatz
 nicht durchgehend isolierend

One-piece sealing insert
 not overall length insulated

G	> Ø < min mm	> Ø < max mm		H mm	L mm	i info	Art.-Nr. Art. No.	
Pg 7	4.5	6.0	15/16	26	6	1	EX1803.80.07.060	50
Pg 7	6.0	7.5	15/16	26	6	1	EX1803.80.07.075	50
Pg 9	6.0	8.0	18/19	30	6	-	EX1803.80.09.080	50
Pg 9	8.0	10.0	18/19	30	6	-	EX1803.80.09.100	50
Pg 11	5.5	8.5	21	31	6	-	EX1803.80.11.085	50
Pg 11	8.5	12.0	21	31	6	-	EX1803.80.11.120	50
Pg 13	8.0	11.0	24	31	6	-	EX1803.80.13.110	50
Pg 13	11.0	14.0	24	31	6	-	EX1803.80.13.140	50
Pg 16	8.0	11.0	24	31	6	-	EX1803.80.16.110	50
Pg 16	11.0	14.0	24	31	6	-	EX1803.80.16.140	50
Pg 21	13.0	16.0	30	35	7.5	-	EX1803.80.21.160	25
Pg 21	16.0	19.0	30	35	7.5	-	EX1803.80.21.190	25
Pg 29	19.0	23.0	38	40	8	-	EX1803.80.29.230	25
Pg 29	23.0	25.5	38	40	8	-	EX1803.80.29.255	25
Pg 36	25.0	30.5	50	47	8	-	EX1803.80.36.305	10
Pg 36	30.5	35.0	50	47	8	-	EX1803.80.36.350	10
Pg 42	33.0	37.0	55	49	10	-	EX1803.80.42.370	10
Pg 42	37.0	41.0	55	49	10	-	EX1803.80.42.410	10
Pg 48	39.0	43.0	65	51	11	-	EX1803.80.48.430	5
Pg 48	43.0	46.5	65	51	11	-	EX1803.80.48.465	5

1 = Zertifikat PTB 02 ATEX 1126X / IECEx SEV 12.0002X

1 = Certificate PTB 02 ATEX 1126X / IECEx SEV 12.0002X

Langes Anschlussgewinde auf Anfrage

Long entry thread available on request

Kurzes Anschlussgewinde metrisch | Short entry thread metric

Material:	Messing vernickelt	Material:	Nickel-plated brass
Dichtung:	TPE / NBR	Seal:	TPE / NBR
Einsatztemperatur:	-40°C / +100°C	Temperature range:	-40°C / +100°C
Schutzart:	IP 66 / IP 68	Protection class:	IP 66 / IP 68
Prüfnorm:	IEC EN 60079-0 / IEC EN 60079-7	Test standard:	IEC EN 60079-0 / IEC EN 60079-7
Kategorie 2G:	Ex e II	Category 2G:	Ex e II
Kategorie 2D:	Ex tD A21	Category 2D:	Ex tD A21
Zone:	Gas 1 und 2 / Staub 21 und 22	Zone:	Gas 1 and 2 / dust 21 and 22
Zertifikat:	EG-Baumuster- prüfbescheinigung PTB 11 ATEX 1022X	Certificate:	EC-type exami- nation certificate PTB 11 ATEX 1022X
IECEX Zertifikat:	IECEX SEV 12.0004X	IECEX Certificate:	IECEX SEV 12.0004X

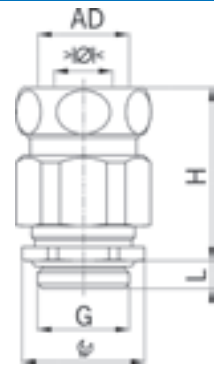

Progress MS Kombi EX



Einteiliger Dichteinsatz
nicht durchgehend isolierend

One-piece sealing insert
not overall length insulated

G	AD mm	> Ø < min mm	> Ø < max mm		H mm	L mm	Art.-Nr. Art. No.	
M12x1.5	10	4.0	6.5	15/17	33	5	EX1700.12.10.065	50
M16x1.5	14	4.5	6.0	18/21	38	5	EX1700.17.14.060	50
M16x1.5	14	6.0	8.0	18/21	38	5	EX1700.17.14.080	50
M16x1.5	14	8.5	10.5	18/21	38	5	EX1700.17.14.105	50
M20x1.5	17	6.5	8.0	24/25	38	6	EX1700.20.17.080	25
M20x1.5	17	9.5	11.0	24/25	38	6	EX1700.20.17.110	25
M20x1.5	19	6.5	8.0	24/27	39	6	EX1700.20.19.080	25
M20x1.5	19	9.5	11.0	24/27	39	6	EX1700.20.19.110	25
M20x1.5	19	12.0	15.0	24/27	39	6	EX1700.20.19.150	25
M20x1.5	21	6.5	8.0	24/29	39	6	EX1700.20.21.080	25
M20x1.5	21	9.5	11.0	24/29	39	6	EX1700.20.21.110	25
M20x1.5	21	12.0	15.0	24/29	39	6	EX1700.20.21.150	25
M25x1.5	21	10.5	12.5	30/29	43	7	EX1700.25.21.125	25
M25x1.5	21	13.0	16.0	30/29	43	7	EX1700.25.21.160	25
M25x1.5	27	10.5	12.5	30/36	50	7	EX1700.25.27.125	25
M25x1.5	27	13.0	16.0	30/36	50	7	EX1700.25.27.160	25
M25x1.5	27	17.0	20.5	30/36	50	7	EX1700.25.27.205	25
M32x1.5	27	19.0	21.0	36/36	52	8	EX1700.32.27.210	25
M40x1.5	36	25.0	28.5	45/45	56	8	EX1700.40.36.285	10
M50x1.5	45	35.0	37.0	55/54	60	9	EX1700.50.45.370	10
M63x1.5	56	44.0	46.0	70/66	67	10	EX1700.63.56.460	5



Langes Anschlussgewinde auf Anfrage

Long entry thread available on request

Je nach Schlauchtyp muss die passende Stabilisierungshülse separat bestellt werden.

Depending on the type of conduit, the stabilising bush must be ordered separately.

Achtung: Es dürfen nur metallische oder metallisch umflochtene Schutzschläuche verwendet werden !

Warning: Only metallic conduits or conduits with metallic braiding may be applied !

AGRO Kabelverschraubungen Progress® Kunststoff GFK erhöhte Sicherheit Ex e II

AGRO synthetic cable glands Progress® GFK increased safety Ex e II

Anschlussgewinde metrisch | Entry thread metric

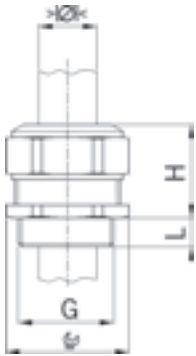

Material: Polyamid glasfaserverstärkt
 Eigenschaften: halogenfrei
 Dichtung: TPE / NBR
 Einsatztemperatur: -20°C / +85°C
 Schutzart: IP 68
 Prüfnorm: IEC EN 60079-0 / IEC EN 60079-7
 Kategorie 2G: Ex e II
 Kategorie 2D: Ex tD A21 IP68
 Zone: Gas 1 und 2 / Staub 21 und 22
 Zertifikat: EG-Baumusterprüfbescheinigung PTB 02 ATEX 1126X
 IECEx Zertifikat: IECEx SEV 12.0002X

Material: Polyamide glass fiber reinforced
 Properties: Halogen-free
 Seal: TPE / NBR
 Temperature range: -20°C / +85°C
 Protection class: IP 68
 Test standard: IEC EN 60079-0 / IEC EN 60079-7
 Category 2G: Ex e II
 Category 2D: Ex tD A21 IP68
 Zone: Gas 1 and 2 / dust 21 and 22
 Certificate: EC-type examination certificate PTB 02 ATEX 1126X
 IECEx Certificate: IECEx SEV 12.0002X

Progress GFK EX



Hellgrau RAL 7035		Light grey RAL 7035							
Einteiliger Dichteinsatz		One-piece sealing insert							
G	>Ø< min mm	>Ø< max mm		H mm	L mm	i info	Art.-Nr. Art. No.		
M16x1.5	4.5	6.0	21	26	12	-	EX1571.17.060	50	
M16x1.5	6.0	8.0	21	26	12	-	EX1571.17.080	50	
M20x1.5	6.0	8.0	27	28	13	-	EX1571.20.080	50	
M20x1.5	8.0	11.0	27	28	13	-	EX1571.20.110	50	
M25x1.5	9.5	12.5	34	33	13	-	EX1571.25.125	25	
M25x1.5	12.5	16.0	34	33	13	-	EX1571.25.160	25	
M25x1.5	16.0	19.0	34	33	13	-	EX1571.25.190	25	
M25x1.5	19.0	20.5	34	33	13	-	EX1571.25.205	25	
M32x1.5	20.0	21.0	41	35	15	-	EX1571.32.210	25	
M32x1.5	21.0	22.0	41	35	15	3	EX1571.32.220	25	
M32x1.5	22.0	23.0	41	35	15	3	EX1571.32.230	25	
M32x1.5	23.0	25.5	41	35	15	-	EX1571.32.255	25	
M40x1.5	25.5	27.0	50	40	15	3	EX1571.40.270	10	
M40x1.5	27.0	28.5	50	40	15	-	EX1571.40.285	10	
M40x1.5	28.5	30.0	50	40	15	3	EX1571.40.300	10	
M40x1.5	30.0	33.0	50	40	15	-	EX1571.40.330	10	
M50x1.5	33.0	35.0	60	42	16	3	EX1571.50.350	10	
M50x1.5	35.0	37.0	60	42	16	-	EX1571.50.370	10	
M50x1.5	37.0	39.0	60	42	16	3	EX1571.50.390	10	
M50x1.5	39.0	42.0	60	42	16	-	EX1571.50.420	10	
M63x1.5	42.0	44.0	75	48	16	3	EX1571.63.440	5	
M63x1.5	44.0	46.0	75	48	16	-	EX1571.63.460	5	
M63x1.5	46.0	48.0	75	48	16	3	EX1571.63.480	5	
M63x1.5	48.0	52.0	75	48	16	-	EX1571.63.520	5	

3 = Material Dichteinsatz NBR

3 = Material sealing insert NBR

AGRO Kabelverschraubungen Progress® Kunststoff GFK erhöhte Sicherheit Ex e II

AGRO synthetic cable glands Progress® GFK increased safety Ex e II

Anschlussgewinde metrisch | Entry thread metric

Material: Polyamid glasfaserverstärkt
 Eigenschaften: halogenfrei
 Dichtung: TPE / NBR
 Einsatztemperatur: -20°C / +85°C
 Schutzart: IP 68
 Prüfnorm: IEC EN 60079-0 / IEC EN 60079-7
 Kategorie 2G: Ex e II
 Kategorie 2D: Ex tD A21 IP68
 Zone: Gas 1 und 2 / Staub 21 und 22
 Zertifikat: EG-Baumusterprüfbescheinigung PTB 02 ATEX 1126X
 IECEx Zertifikat: IECEx SEV 12.0002X

Material: Polyamide glass fiber reinforced
 Properties: Halogen-free
 Seal: TPE / NBR
 Temperature range: -20°C / +85°C
 Protection class: IP 68
 Test standard: IEC EN 60079-0 / IEC EN 60079-7
 Category 2G: Ex e II
 Category 2D: Ex tD A21 IP68
 Zone: Gas 1 and 2 / dust 21 and 22
 Certificate: EC-type examination certificate PTB 02 ATEX 1126X
 IECEx Certificate: IECEx SEV 12.0002X

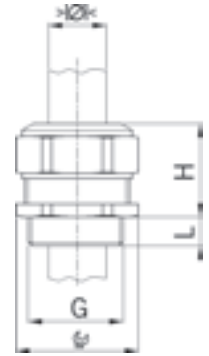

Progress GFK EX



Schwarz RAL 9005
 Einteiliger Dichteinsatz
 Black RAL 9005
 One-piece sealing insert

G	>Ø< min mm	>Ø< max mm		H mm	L mm	i info	Art.-Nr. Art. No.	
M16x1.5	4.5	6.0	21	26	12	-	EX1540.17.060	50
M16x1.5	6.0	8.0	21	26	12	-	EX1540.17.080	50
M20x1.5	6.0	8.0	27	28	13	-	EX1540.20.080	50
M20x1.5	8.0	11.0	27	28	13	-	EX1540.20.110	50
M25x1.5	9.5	12.5	34	33	13	-	EX1540.25.125	25
M25x1.5	12.5	16.0	34	33	13	-	EX1540.25.160	25
M25x1.5	16.0	19.0	34	33	13	-	EX1540.25.190	25
M25x1.5	19.0	20.5	34	33	13	-	EX1540.25.205	25
M32x1.5	20.0	21.0	41	35	15	-	EX1540.32.210	25
M32x1.5	21.0	22.0	41	35	15	3	EX1540.32.220	25
M32x1.5	22.0	23.0	41	35	15	3	EX1540.32.230	25
M32x1.5	23.0	25.5	41	35	15	-	EX1540.32.255	25
M40x1.5	25.5	27.0	50	40	15	3	EX1540.40.270	10
M40x1.5	27.0	28.5	50	40	15	-	EX1540.40.285	10
M40x1.5	28.5	30.0	50	40	15	3	EX1540.40.300	10
M40x1.5	30.0	33.0	50	40	15	-	EX1540.40.330	10
M50x1.5	33.0	35.0	60	42	16	3	EX1540.50.350	10
M50x1.5	35.0	37.0	60	42	16	-	EX1540.50.370	10
M50x1.5	37.0	39.0	60	42	16	3	EX1540.50.390	10
M50x1.5	39.0	42.0	60	42	16	-	EX1540.50.420	10
M63x1.5	42.0	44.0	75	48	16	3	EX1540.63.440	5
M63x1.5	44.0	46.0	75	48	16	-	EX1540.63.460	5
M63x1.5	46.0	48.0	75	48	16	3	EX1540.63.480	5
M63x1.5	48.0	52.0	75	48	16	-	EX1540.63.520	5

3 = Material Dichteinsatz NBR

3 = Material sealing insert NBR



AGRO Kabelverschraubungen Progress® Kunststoff GFK erhöhte Sicherheit Ex e II

AGRO synthetic cable glands Progress® GFK increased safety Ex e II

Anschlussgewinde Pg | Entry thread Pg

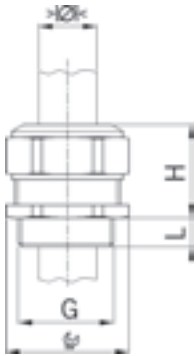

Material: Polyamid glasfaserverstärkt
 Eigenschaften: halogenfrei
 Dichtung: TPE / NBR
 Einsatztemperatur: -20°C / +85°C
 Schutzart: IP 68
 Prüfnorm: IEC EN 60079-0 / IEC EN 60079-7
 Kategorie 2G: Ex e II
 Kategorie 2D: Ex tD A21 IP68
 Zone: Gas 1 und 2 / Staub 21 und 22
 Zertifikat: EG-Baumusterprüfbescheinigung PTB 02 ATEX 1126X
 IECEx Zertifikat: IECEx SEV 12.0002X

Material: Polyamide glass fiber reinforced
 Properties: Halogen-free
 Seal: TPE / NBR
 Temperature range: -20°C / +85°C
 Protection class: IP 68
 Test standard: IEC EN 60079-0 / IEC EN 60079-7
 Category 2G: Ex e II
 Category 2D: Ex tD A21 IP68
 Zone: Gas 1 and 2 / dust 21 and 22
 Certificate: EC-type examination certificate PTB 02 ATEX 1126X
 IECEx Certificate: IECEx SEV 12.0002X

Progress GFK EX



Hellgrau RAL 7035
 Einteiliger Dichteinsatz

Light grey RAL 7035
 One-piece sealing insert

G	>Ø< min mm	>Ø< max mm		H mm	L mm	i info	Art.-Nr. Art. No.	
Pg 9	4.5	6.0	21	26	12	-	EX1571.09.060	50
Pg 9	6.0	8.0	21	26	12	-	EX1571.09.080	50
Pg 11	4.0	5.5	24	28	12	-	EX1571.11.055	50
Pg 11	5.5	8.5	24	28	12	-	EX1571.11.085	50
Pg 13	6.0	8.0	27	28	13	-	EX1571.13.080	50
Pg 13	8.0	11.0	27	28	13	-	EX1571.13.110	50
Pg 16	6.0	8.0	27	28	13	-	EX1571.16.080	50
Pg 16	8.0	11.0	27	28	13	-	EX1571.16.110	50
Pg 21	9.5	12.5	34	33	13	-	EX1571.21.125	25
Pg 21	12.5	16.0	34	33	13	-	EX1571.21.160	25
Pg 21	16.0	19.0	34	33	13	-	EX1571.21.190	25
Pg 21	19.0	20.5	34	33	13	-	EX1571.21.205	25
Pg 29	19.5	21.0	41	36	13	3	EX1571.29.210	25
Pg 29	21.0	23.0	41	36	13	-	EX1571.29.230	25
Pg 29	23.0	25.0	41	36	13	3	EX1571.29.250	25
Pg 29	25.0	27.5	41	36	13	-	EX1571.29.275	25
Pg 36	27.0	28.5	55	42	16	3	EX1571.36.285	10
Pg 36	28.5	30.5	55	42	16	-	EX1571.36.305	10
Pg 36	30.5	32.5	55	42	16	3	EX1571.36.325	10
Pg 36	32.5	35.0	55	42	16	-	EX1571.36.350	10
Pg 42	33.0	35.0	60	42	16	3	EX1571.42.350	10
Pg 42	35.0	37.0	60	42	16	-	EX1571.42.370	10
Pg 42	37.0	39.0	60	42	16	3	EX1571.42.390	10
Pg 42	39.0	42.0	60	42	16	-	EX1571.42.420	10
Pg 48	41.0	43.0	70	46	16	-	EX1571.48.430	5
Pg 48	43.0	45.0	70	46	16	3	EX1571.48.450	5
Pg 48	45.0	47.0	70	46	16	3	EX1571.48.470	25
Pg 48	47.0	49.0	70	46	16	-	EX1571.48.490	5

3 = Material Dichteinsatz NBR

3 = Material sealing insert NBR

AGRO Kabelverschraubungen Progress® Kunststoff GFK erhöhte Sicherheit Ex e II

AGRO synthetic cable glands Progress® GFK increased safety Ex e II

Anschlussgewinde Pg | Entry thread Pg

Material: Polyamid glasfaserverstärkt
 Eigenschaften: halogenfrei
 Dichtung: TPE / NBR
 Einsatztemperatur: -20°C / +85°C
 Schutzart: IP 68
 Prüfnorm: IEC EN 60079-0 / IEC EN 60079-7
 Kategorie 2G: Ex e II
 Kategorie 2D: Ex tD A21 IP68
 Zone: Gas 1 und 2 / Staub 21 und 22
 Zertifikat: EG-Baumusterprüfbescheinigung PTB 02 ATEX 1126X
 IECEx Zertifikat: IECEx SEV 12.0002X

Material: Polyamide glass fiber reinforced
 Properties: Halogen-free
 Seal: TPE / NBR
 Temperature range: -20°C / +85°C
 Protection class: IP 68
 Test standard: IEC EN 60079-0 / IEC EN 60079-7
 Category 2G: Ex e II
 Category 2D: Ex tD A21 IP68
 Zone: Gas 1 and 2 / dust 21 and 22
 Certificate: EC-type examination certificate PTB 02 ATEX 1126X
 IECEx Certificate: IECEx SEV 12.0002X

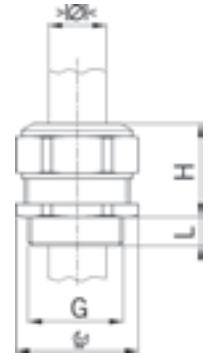

Progress GFK EX



Schwarz RAL 9005
 Einteiliger Dichteinsatz

Black RAL 9005
 One-piece sealing insert

G	> Ø < min mm	> Ø < max mm		H mm	L mm	i info	Art.-Nr. Art. No.	
Pg 9	4.5	6.0	21	26	12	-	EX1540.09.060	50
Pg 9	6.0	8.0	21	26	12	-	EX1540.09.080	50
Pg 11	4.0	5.5	24	28	12	-	EX1540.11.055	50
Pg 11	5.5	8.5	24	28	12	-	EX1540.11.085	50
Pg 13	6.0	8.0	27	28	13	-	EX1540.13.080	50
Pg 13	8.0	11.0	27	28	13	-	EX1540.13.110	50
Pg 16	6.0	8.0	27	28	13	-	EX1540.16.080	50
Pg 16	8.0	11.0	27	28	13	-	EX1540.16.110	50
Pg 21	9.5	12.5	34	33	13	-	EX1540.21.125	25
Pg 21	12.5	16.0	34	33	13	-	EX1540.21.160	25
Pg 21	16.0	19.0	34	33	13	-	EX1540.21.190	25
Pg 21	19.0	20.5	34	33	13	-	EX1540.21.205	25
Pg 29	19.5	21.0	41	36	13	3	EX1540.29.210	25
Pg 29	21.0	23.0	41	36	13	-	EX1540.29.230	25
Pg 29	23.0	25.0	41	36	13	3	EX1540.29.250	25
Pg 29	25.0	27.5	41	36	13	-	EX1540.29.275	25
Pg 36	27.0	28.5	55	42	16	3	EX1540.36.285	10
Pg 36	28.5	30.5	55	42	16	-	EX1540.36.305	10
Pg 36	30.5	32.5	55	42	16	3	EX1540.36.325	10
Pg 36	32.5	35.0	55	42	16	-	EX1540.36.350	10
Pg 42	33.0	35.0	60	42	16	3	EX1540.42.350	10
Pg 42	35.0	37.0	60	42	16	-	EX1540.42.370	10
Pg 42	37.0	39.0	60	42	16	3	EX1540.42.390	10
Pg 42	39.0	42.0	60	42	16	-	EX1540.42.420	10
Pg 48	41.0	43.0	70	46	16	-	EX1540.48.430	5
Pg 48	43.0	45.0	70	46	16	3	EX1540.48.450	5
Pg 48	45.0	47.0	70	46	16	3	EX1540.48.470	5
Pg 48	47.0	49.0	70	46	16	-	EX1540.48.490	5

3 = Material Dichteinsatz NBR

3 = Material sealing insert NBR



Anschlussgewinde metrisch | Entry thread metric

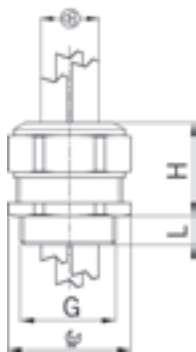

Material: Polyamid glasfaserverstärkt
 Eigenschaften: halogenfrei
 Dichtung: TPE / NBR
 Einsatztemperatur: -20°C / +85°C
 Schutzart: IP 68
 Prüfnorm: IEC EN 60079-0 / IEC EN 60079-7
 Kategorie 2G: Ex e II
 Kategorie 2D: Ex tD A21 IP68
 Zone: Gas 1 und 2 / Staub 21 und 22
 Zertifikat: EG-Baumusterprüfbescheinigung PTB 02 ATEX 1126X
 IECEx Zertifikat: IECEx SEV 12.0002X

Material: Polyamide glass fiber reinforced
 Properties: Halogen-free
 Seal: TPE / NBR
 Temperature range: -20°C / +85°C
 Protection class: IP 68
 Test standard: IEC EN 60079-0 / IEC EN 60079-7
 Category 2G: Ex e II
 Category 2D: Ex tD A21 IP68
 Zone: Gas 1 and 2 / dust 21 and 22
 Certificate: EC-type examination certificate PTB 02 ATEX 1126X
 IECEx Certificate: IECEx SEV 12.0002X

Progress GFK Multi EX



Hellgrau RAL 7035
 Einteiliger Dichteinsatz
 Light grey RAL 7035
 One-piece sealing insert

G	>Ø< min mm	>Ø< max mm	⊙	☍	H mm	L mm	i info	Art.-Nr. Art. No.	
M16x1.5	1.0	1.5	4	21	26	12	3	EX1571.17.4.015	50
M16x1.5	2.0	3.0	2	21	26	12	-	EX1571.17.2.030	50
M20x1.5	2.5	3.0	6	27	28	13	-	EX1571.20.6.030	50
M20x1.5	3.5	5.0	2	27	28	13	-	EX1571.20.2.050	50
M25x1.5	5.0	6.0	6	34	33	13	-	EX1571.25.6.060	25
M25x1.5	5.5	7.0	4	34	33	13	-	EX1571.25.4.070	25
M25x1.5	7.5	9.0	3	34	33	13	-	EX1571.25.3.090	25
M25x1.5	8.0	10.0	2	34	33	13	-	EX1571.25.2.100	25
M32x1.5	6.0	7.0	6	41	35	15	-	EX1571.32.6.070	25
M32x1.5	7.5	9.0	4	41	35	15	-	EX1571.32.4.090	25
M40x1.5	8.0	9.0	7	50	40	15	3	EX1571.40.7.090	10
M40x1.5	14.0	15.0	2	50	40	15	3	EX1571.40.2.150	10
M50x1.5	9.0	10.0	4	60	42	16	3	EX1571.50.4.100	10
M63x1.5	11.0	12.0	6	75	48	16	3	EX1571.63.6.120	5
M63x1.5	17.0	18.0	3	75	48	16	3	EX1571.63.3.180	5

3 = Material Dichteinsatz NBR

3 = Material sealing insert NBR

Progress GFK Multi EX



Schwarz RAL 9005
 Einteiliger Dichteinsatz
 Black RAL 9005
 One-piece sealing insert

G	>Ø< min mm	>Ø< max mm	⊙	☍	H mm	L mm	i info	Art.-Nr. Art. No.	
M16x1.5	1.0	1.5	4	21	26	12	3	EX1540.17.4.015	50
M16x1.5	2.0	3.0	2	21	26	12	-	EX1540.17.2.030	50
M20x1.5	2.5	3.0	6	27	28	13	-	EX1540.20.6.030	50
M20x1.5	3.5	5.0	2	27	28	13	-	EX1540.20.2.050	50
M25x1.5	5.0	6.0	6	34	33	13	-	EX1540.25.6.060	25
M25x1.5	5.0	7.0	4	34	33	13	-	EX1540.25.4.070	25
M25x1.5	7.5	9.0	3	34	33	13	-	EX1540.25.3.090	25
M25x1.5	8.0	10.0	2	34	33	13	-	EX1540.25.2.100	25
M32x1.5	6.0	7.0	6	41	33	13	-	EX1540.32.6.070	25
M32x1.5	7.5	9.0	4	41	35	15	-	EX1540.32.4.090	25
M40x1.5	8.0	9.0	7	50	40	15	3	EX1540.40.7.090	10
M40x1.5	14.0	15.0	2	50	40	15	3	EX1540.40.2.150	10
M50x1.5	9.0	10.0	4	60	42	16	3	EX1540.50.4.100	10
M63x1.5	11.0	12.0	6	75	48	16	3	EX1540.63.6.120	5
M63x1.5	17.0	18.0	3	75	48	16	3	EX1540.63.3.180	5

3 = Material Dichteinsatz NBR

3 = Material sealing insert NBR

Anschlussgewinde Pg | Entry thread Pg

Material: Polyamid glasfaserverstärkt
 Eigenschaften: halogenfrei
 Dichtung: TPE / NBR
 Einsatztemperatur: -20°C / +85°C
 Schutzart: IP 68
 Prüfnorm: IEC EN 60079-0 / IEC EN 60079-7
 Kategorie 2G: Ex e II
 Kategorie 2D: Ex tD A21 IP68
 Zone: Gas 1 und 2 / Staub 21 und 22
 Zertifikat: EG-Baumusterprüfbescheinigung PTB 02 ATEX 1126X
 IECEx Zertifikat: IECEx SEV 12.0002X

Material: Polyamide glass fiber reinforced
 Properties: Halogen-free
 Seal: TPE / NBR
 Temperature range: -20°C / +85°C
 Protection class: IP 68
 Test standard: IEC EN 60079-0 / IEC EN 60079-7
 Category 2G: Ex e II
 Category 2D: Ex tD A21 IP68
 Zone: Gas 1 and 2 / dust 21 and 22
 Certificate: EC-type examination certificate PTB 02 ATEX 1126X
 IECEx Certificate: IECEx SEV 12.0002X

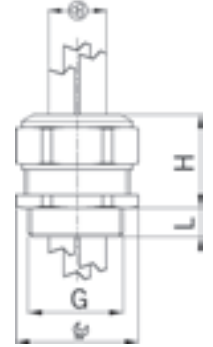

Progress GFK Multi EX



Hellgrau RAL 7035 Einteiliger Dichteinsatz					Light grey RAL 7035 One-piece sealing insert				
G	$\begin{matrix} >\varnothing < \\ \text{min mm} \end{matrix}$	$\begin{matrix} >\varnothing < \\ \text{max mm} \end{matrix}$			H mm	L mm	i info	Art.-Nr. Art. No.	
Pg 9	1.0	1.5	4	21	26	12	3	EX1571.09.4.015	50
Pg 9	2.0	3.0	2	21	26	12	-	EX1571.09.2.030	50
Pg 11	3.5	5.0	2	24	28	12	-	EX1571.11.2.050	50
Pg 11	2.0	3.0	3	24	28	12	3	EX1571.11.3.030	50
Pg 13	2.5	4.0	3	27	28	13	3	EX1571.13.3.040	50
Pg 13	3.5	5.0	2	27	28	13	-	EX1571.13.2.050	50
Pg 16	2.5	3.0	6	27	28	13	-	EX1571.16.6.030	50
Pg 16	4.5	6.0	3	27	28	13	-	EX1571.16.3.060	50
Pg 21	5.5	7.0	4	34	33	13	-	EX1571.21.4.070	25
Pg 21	7.5	9.0	3	34	33	13	-	EX1571.21.3.090	25
Pg 29	5.5	6.5	6	41	36	13	3	EX1571.29.6.065	25
Pg 29	8.0	9.0	3	41	36	13	3	EX1571.29.3.090	25
Pg 36	9.0	10.0	4	55	42	16	3	EX1571.36.4.100	10
Pg 36	14.0	15.0	2	55	42	16	3	EX1571.36.2.150	10
Pg 42	9.0	10.0	4	60	42	16	3	EX1571.42.4.100	10
Pg 48	11.0	12.0	6	70	46	16	3	EX1571.48.6.120	5
Pg 48	17.0	18.0	3	70	46	16	3	EX1571.48.3.180	5

3 = Material Dichteinsatz NBR
 3 = Material sealing insert NBR



Progress GFK Multi EX



Schwarz RAL 9005 Einteiliger Dichteinsatz					Black RAL 9005 One-piece sealing insert				
G	$\begin{matrix} >\varnothing < \\ \text{min mm} \end{matrix}$	$\begin{matrix} >\varnothing < \\ \text{max mm} \end{matrix}$			H mm	L mm	i info	Art.-Nr. Art. No.	
Pg 9	1.0	1.5	4	21	26	12	3	EX1540.09.4.015	50
Pg 9	2.0	3.0	2	21	26	12	-	EX1540.09.2.030	50
Pg 11	2.0	3.0	3	24	28	12	3	EX1540.11.3.030	50
Pg 11	3.5	5.0	2	24	28	12	-	EX1540.11.2.050	50
Pg 13	2.5	4.0	3	27	28	13	3	EX1540.13.3.040	50
Pg 13	3.5	5.0	2	27	28	13	-	EX1540.13.2.050	50
Pg 16	2.5	3.0	6	27	28	13	-	EX1540.16.6.030	50
Pg 16	4.5	6.0	3	27	28	13	-	EX1540.16.3.060	50
Pg 21	5.5	7.0	4	34	33	13	-	EX1540.21.4.070	25
Pg 21	7.5	9.0	3	34	33	13	-	EX1540.21.3.090	25
Pg 29	5.5	6.5	6	41	36	13	3	EX1540.29.6.065	25
Pg 29	8.0	9.0	3	41	36	13	3	EX1540.29.3.090	25
Pg 36	14.0	15.0	2	55	42	16	3	EX1540.36.2.150	10
Pg 36	9.0	10.0	4	55	42	16	3	EX1540.36.4.100	10
Pg 42	9.0	10.0	4	60	42	16	3	EX1540.42.4.100	10
Pg 48	11.0	12.0	6	70	46	16	3	EX1540.48.6.120	5
Pg 48	17.0	18.0	3	70	46	16	3	EX1540.48.3.180	5

3 = Material Dichteinsatz NBR
 3 = Material sealing insert NBR



Anschlussgewinde metrisch | Entry thread metric

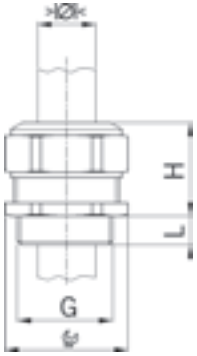

Material: Polyamid glasfaserverstärkt
 Eigenschaften: halogenfrei
 Dichtung: TPE / NBR
 Einsatztemperatur: -20°C / +85°C
 Schutzart: IP 68
 Prüfnorm: IEC EN 60079-0 / IEC EN 60079-7
 Kategorie 2G: Ex e II / i II
 Kategorie 2D: Ex tD A21 IP68
 Zone: Gas 0, 1 und 2 / Staub 20, 21 und 22
 Zertifikat: EG-Baumusterprüfbescheinigung PTB 02 ATEX 1126X
 IECEx Zertifikat: IECEx SEV 12.0002X

Material: Polyamide glass fiber reinforced
 Properties: Halogen-free
 Seal: TPE / NBR
 Temperature range: -20°C / +85°C
 Protection class: IP 68
 Test standard: IEC EN 60079-0 / IEC EN 60079-7
 Category 2G: Ex e II / i II
 Category 2D: Ex tD A21 IP68
 Zone: Gas 0, 1 and 2 / dust 20, 21 and 22
 Certificate: EC-type examination certificate PTB 02 ATEX 1126X
 IECEx Certificate: IECEx SEV 12.0002X

Progress GFK EX



Lichtblau RAL 5012
 Einteiliger Dichteinsatz

Light blue RAL 5012
 One-piece sealing insert

G	>Ø< min mm	>Ø< max mm		H mm	L mm	i info	Art.-Nr. Art. No.	
M16x1.5	4.5	6.0	21	26	12	-	EX1530.17.060	50
M16x1.5	6.0	8.0	21	26	12	-	EX1530.17.080	50
M20x1.5	6.0	8.0	27	28	13	-	EX1530.20.080	50
M20x1.5	8.0	11.0	27	28	13	-	EX1530.20.110	50
M25x1.5	9.5	12.5	34	33	13	-	EX1530.25.125	25
M25x1.5	12.5	16.0	34	33	13	-	EX1530.25.160	25
M25x1.5	16.0	19.0	34	33	13	-	EX1530.25.190	25
M25x1.5	19.0	20.5	34	33	13	-	EX1530.25.205	25
M32x1.5	20.0	21.0	41	35	15	-	EX1530.32.210	25
M32x1.5	21.0	22.0	41	35	15	3	EX1530.32.220	25
M32x1.5	22.0	23.0	41	35	15	3	EX1530.32.230	25
M32x1.5	23.0	25.5	41	35	15	-	EX1530.32.255	25
M40x1.5	25.5	27.0	50	40	15	3	EX1530.40.270	10
M40x1.5	27.0	28.5	50	40	15	-	EX1530.40.285	10
M40x1.5	28.5	30.0	50	40	15	3	EX1530.40.300	10
M40x1.5	30.0	33.0	50	40	15	-	EX1530.40.330	10
M50x1.5	33.0	35.0	60	42	16	3	EX1530.50.350	10
M50x1.5	35.0	37.0	60	42	16	-	EX1530.50.370	10
M50x1.5	37.0	39.0	60	42	16	3	EX1530.50.390	10
M50x1.5	39.0	42.0	60	42	16	-	EX1530.50.420	10
M63x1.5	42.0	44.0	75	48	16	3	EX1530.63.440	5
M63x1.5	44.0	46.0	75	48	16	-	EX1530.63.460	5
M63x1.5	46.0	48.0	75	48	16	3	EX1530.63.480	5
M63x1.5	48.0	52.0	75	48	16	-	EX1530.63.520	5

3 = Material Dichteinsatz NBR

3 = Material sealing insert NBR

Auf Anfrage lieferbar:

Available on request:

Für mehrere Kabel

For installation of multiple cables

Anschlussgewinde Pg | Entry thread Pg

Material: Polyamid glasfaserverstärkt
 Eigenschaften: halogenfrei
 Dichtung: TPE / NBR
 Einsatztemperatur: -20°C / +85°C
 Schutzart: IP 68
 Prüfnorm: IEC EN 60079-0 / IEC EN 60079-7
 Kategorie 2G: Ex e II / i II
 Kategorie 2D: Ex tD A21 IP68
 Zone: Gas 0, 1 und 2 / Staub 20, 21 und 22
 Zertifikat: EG-Baumusterprüfbescheinigung PTB 02 ATEX 1126X
 IECEx Zertifikat: IECEx SEV 12.0002X

Material: Polyamide glass fiber reinforced
 Properties: Halogen-free
 Seal: TPE / NBR
 Temperature range: -20°C / +85°C
 Protection class: IP 68
 Test standard: IEC EN 60079-0 / IEC EN 60079-7
 Category 2G: Ex e II / i II
 Category 2D: Ex tD A21 IP68
 Zone: Gas 0, 1 and 2 / dust 20, 21 and 22
 Certificate: EC-type examination certificate PTB 02 ATEX 1126X
 IECEx Certificate: IECEx SEV 12.0002X

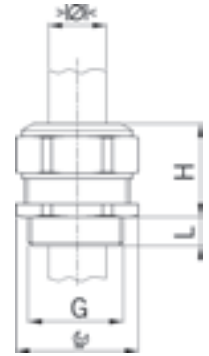

Progress GFK EX



Lichtblau RAL 5012		Light blue RAL 5012						
Einteiliger Dichteinsatz		One-piece sealing insert						
G	> Ø < min mm	> Ø < max mm	i info	Art.-Nr. Art. No.				
Pg 9	4.5	6.0	21	26	12	-	EX1530.09.060	50
Pg 9	6.0	8.0	21	26	12	-	EX1530.09.080	50
Pg 11	4.0	5.5	24	28	12	-	EX1530.11.055	50
Pg 11	5.5	8.5	24	28	12	-	EX1530.11.085	50
Pg 13	6.0	8.0	27	28	13	-	EX1530.13.080	50
Pg 13	8.0	11.0	27	28	13	-	EX1530.13.110	50
Pg 16	6.0	8.0	27	28	13	-	EX1530.16.080	50
Pg 16	8.0	11.0	27	28	13	-	EX1530.16.110	50
Pg 21	9.5	12.5	34	33	13	-	EX1530.21.125	25
Pg 21	12.5	16.0	34	33	13	-	EX1530.21.160	25
Pg 21	16.0	19.0	34	33	13	-	EX1530.21.190	25
Pg 21	19.0	20.5	34	33	13	-	EX1530.21.205	25
Pg 29	19.5	21.0	41	36	13	3	EX1530.29.210	25
Pg 29	21.0	23.0	41	36	13	-	EX1530.29.230	25
Pg 29	23.0	25.0	41	36	13	3	EX1530.29.250	25
Pg 29	25.0	27.5	41	36	13	-	EX1530.29.275	25
Pg 36	27.0	28.5	55	42	16	3	EX1530.36.285	10
Pg 36	28.5	30.5	55	42	16	-	EX1530.36.305	10
Pg 36	30.5	32.5	55	42	16	3	EX1530.36.325	10
Pg 36	32.5	35.0	55	42	16	-	EX1530.36.350	10
Pg 42	33.0	35.0	60	42	16	3	EX1530.42.350	10
Pg 42	35.0	37.0	60	42	16	-	EX1530.42.370	10
Pg 42	37.0	39.0	60	42	16	3	EX1530.42.390	10
Pg 42	39.0	42.0	60	42	16	-	EX1530.42.420	10
Pg 48	41.0	43.0	70	46	16	-	EX1530.48.430	5
Pg 48	43.0	45.0	70	46	16	3	EX1530.48.450	5
Pg 48	45.0	47.0	70	46	16	3	EX1530.48.470	5
Pg 48	47.0	49.0	70	46	16	-	EX1530.48.490	5

3 = Material Dichteinsatz NBR
 3 = Material sealing insert NBR

Auf Anfrage lieferbar:
 Für mehrere Kabel

Available on request:
 For installation of multiple cables



Zubehör zu Kabelverschraubungen Messing und Kunststoff erhöhte Sicherheit Ex e II

Accessories for cable glands brass and synthetic for increased safety Ex e II

Zubehör | Accessories

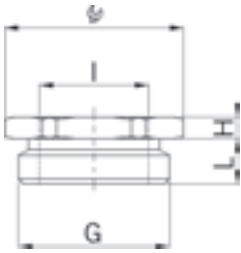

Reduktionen Messing erhöhte Sicherheit Ex e II

Material:	Messing vernickelt
O-Ring :	NBR
Einsatztemperatur:	-40°C / +100°C
Schutzart:	IP 68
Prüfnorm:	IEC EN 60079-0 / IEC EN 60079-7
Kategorie 2G:	Ex e II
Kategorie 2D:	Ex tD A21 IP68
Zone:	Gas 1 und 2 / Staub 21 und 22
Zertifikat:	EG-Baumuster- prüfbescheinigung PTB 02 ATEX 1125
IECEx Zertifikat:	IECEx SEV 12.0001

Reduction fittings nickel-plated brass increased safety Ex e II

Material:	Nickel-plated brass
O-ring :	NBR
Temperature range:	-40°C / +100°C
Protection class:	IP 68
Test standard:	IEC EN 60079-0 / IEC EN 60079-7
Category 2G:	Ex e II
Category 2D:	Ex tD A21 IP68
Zone:	Gas 1 and 2 / dust 21 and 22
Certificate:	EC-type test certificate PTB 02 ATEX 1125
IECEx Certificate:	IECEx SEV 12.0001



Reduktion MS EX



Aussengewinde metrisch
Innengewinde metrisch
mit O-Ring

Outer thread metric
Inner thread metric
with O-ring

G	I	i info	1	H mm	L mm	i info	Art.-Nr. Art. No.	
M10x1.5	M 8x1.25	1	13	8.0	5	2	EX3500.10.08	50
M12x1.5	M 8x1.25	1	15	3.0	5	2	EX3500.12.08	50
M12x1.5	M10x1.5	1	15	8.0	5	2	EX3500.12.10	50
M16x1.5	M10x1.5	1	18	3.0	5	-	EX3500.17.10	50
M16x1.5	M12x1.5	-	18	3.0	5	-	EX3500.17.12	50
M20x1.5	M12x1.5	-	24	3.0	6	-	EX3500.20.12	50
M20x1.5	M16x1.5	-	24	3.0	6	-	EX3500.20.17	50
M25x1.5	M16x1.5	-	30	3.5	7	-	EX3500.25.17	25
M25x1.5	M20x1.5	-	30	3.5	7	-	EX3500.25.20	25
M32x1.5	M20x1.5	-	36	4.0	8	-	EX3500.32.20	20
M32x1.5	M25x1.5	-	36	4.0	8	-	EX3500.32.25	20
M40x1.5	M25x1.5	-	46	4.5	8	-	EX3500.40.25	10
M40x1.5	M32x1.5	-	46	4.5	8	-	EX3500.40.32	10
M50x1.5	M32x1.5	-	55	5.0	9	-	EX3500.50.32	10
M50x1.5	M40x1.5	-	55	5.0	9	-	EX3500.50.40	10
M63x1.5	M40x1.5	-	70	5.5	10	-	EX3500.63.40	5
M63x1.5	M50x1.5	-	70	5.5	10	-	EX3500.63.50	5

1 = Metrisches Regelgewinde

1 = Metric coarse-pitch thread

2 = Zertifikat PTB 02 ATEX 1126X / IECEx SEV 12.0002X

2 = Certificate PTB 02 ATEX 1126X / IECEx SEV 12.0002X

Das Ineinanderschrauben mehrerer Reduktionen/Erweiterungen ist nach Norm nicht zulässig!

The norm interdicts to screw several reduction/enlarging fittings into each other!

Auf Anfrage lieferbar:

Available on request:

Reduktionen Messing mit FMP-O-Ring für Einsatztemperaturen bis +200°C

Reduction fittings nickel-plated brass with FPM O-ring for high temperature applications up to +200°C

Zubehör zu Kabelverschraubungen Messing und Kunststoff erhöhte Sicherheit Ex e II

Accessories for cable glands brass and synthetic for increased safety Ex e II

Zubehör | Accessories

Reduktionen Messing erhöhte Sicherheit Ex e II

Material:	Messing vernickelt
O-Ring :	NBR
Einsatztemperatur:	-40°C / +100°C
Schutzart:	IP 68
Prüfnorm:	IEC EN 60079-0 / IEC EN 60079-7
Kategorie 2G:	Ex e II
Kategorie 2D:	Ex tD A21 IP68
Zone:	Gas 1 und 2 / Staub 21 und 22
Zertifikat:	EG-Baumuster- prüfbescheinigung PTB 02 ATEX 1125, Größe Pg 7 PTB 02 ATEX 1126X
IECEx Zertifikat:	IECEx SEV 12.0001

Reduction fittings nickel-plated brass increased safety Ex e II

Material:	Nickel-plated brass
O-ring :	NBR
Temperature range:	-40°C / +100°C
Protection class:	IP 68
Test standard:	IEC EN 60079-0 / IEC EN 60079-7
Category 2G:	Ex e II
Category 2D:	Ex tD A21 IP68
Zone:	Gas 1 and 2 / dust 21 and 22
Certificate:	EC-type exami- nation certificate PTB 02 ATEX 1125, size Pg 7 PTB 02 ATEX 1126X
IECEx Certificate:	IECEx SEV 12.0001

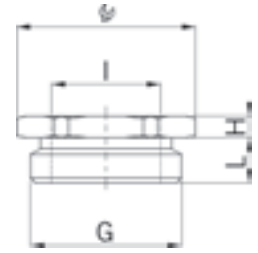

Reduktion MS EX



Aussengewinde Pg
Innengewinde metrisch
mit O-Ring

Outer thread Pg
Inner thread metric
with O-ring

G	I	i info		H mm	L mm	i info	Art.-Nr. Art. No.	
Pg 7	M 8x1.25	1	15	3.0	6	2	EX3500.07.08	50
Pg 7	M 10x1.5	1	15	7.0	6	2	EX3500.07.10	50
Pg 9	M 8x1.25	1	18	3.0	6	-	EX3500.09.08	50
Pg 9	M 10x1.5	1	18	3.0	6	-	EX3500.09.10	50
Pg 9	M 12x1.5	-	18	8.0	6	-	EX3500.09.12	50
Pg 11	M 8x1.25	1	21	3.0	6	-	EX3500.11.08	50
Pg 11	M 10x1.5	1	21	3.0	6	-	EX3500.11.10	50
Pg 11	M 12x1.5	-	21	3.0	6	-	EX3500.11.12	50
Pg 11	M 16x1.5	-	21	8.0	6	-	EX3500.11.17	50
Pg 13	M 12x1.5	-	24	3.0	6	-	EX3500.13.12	50
Pg 13	M 16x1.5	-	24	3.0	6	-	EX3500.13.17	50
Pg 16	M 12x1.5	-	24	3.0	6	-	EX3500.16.12	25
Pg 16	M 16x1.5	-	24	3.0	6	-	EX3500.16.17	25
Pg 16	M 20x1.5	-	24	10.5	6	-	EX3500.16.20	25
Pg 21	M 16x1.5	-	30	3.5	7.5	-	EX3500.21.17	25
Pg 21	M 20x1.5	-	30	3.5	7.5	-	EX3500.21.20	25
Pg 21	M 25x1.5	-	30	10.5	7.5	-	EX3500.21.25	25
Pg 29	M 25x1.5	-	38	4.0	8	-	EX3500.29.25	20
Pg 29	M 32x1.5	-	38	13.0	8	-	EX3500.29.32	20
Pg 36	M 32x1.5	-	50	4.5	8	-	EX3500.36.32	10
Pg 36	M 40x1.5	-	50	4.5	8	-	EX3500.36.40	10
Pg 42	M 32x1.5	-	55	5.0	10	-	EX3500.42.32	10
Pg 42	M 40x1.5	-	55	5.0	10	-	EX3500.42.40	10
Pg 42	M 50x1.5	-	55	15.0	10	-	EX3500.42.50	10
Pg 48	M 40x1.5	-	65	5.5	11	-	EX3500.48.40	5
Pg 48	M 50x1.5	-	65	5.5	11	-	EX3500.48.50	5



1 = Metrisches Regelgewinde

1 = Metric coarse-pitch thread

2 = Zertifikat PTB 02 ATEX 1126X / IECEx SEV 12.0002X

2 = Certificate PTB 02 ATEX 1126X / IECEx SEV 12.0002X

Das Ineinanderschrauben mehrerer Reduktionen/Erweiterungen ist nach Norm nicht zulässig!

The norm interdicts to screw several reduction/enlarging fittings into each other!

Auf Anfrage lieferbar:

Available on request:

Reduktionen Messing mit FMP-O-Ring für Einsatztemperaturen bis +200°C

Reduction fittings nickel-plated brass with FPM O-ring for high temperature applications up to +200°C

Zubehör zu Kabelverschraubungen Messing und Kunststoff erhöhte Sicherheit Ex e II

Accessories for cable glands brass and synthetic for increased safety Ex e II

Zubehör | Accessories

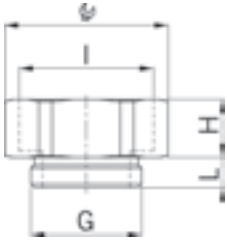

Erweiterungen Messing erhöhte Sicherheit Ex e II

Material:	Messing vernickelt
O-Ring :	NBR
Einsatztemperatur:	-40°C / +100°C
Schutzart:	IP 68
Prüfnorm:	IEC EN 60079-0 / IEC EN 60079-7
Kategorie 2G:	Ex e II
Kategorie 2D:	Ex tD A21 IP68
Zone:	Gas 1 und 2 / Staub 21 und 22
Zertifikat:	EG-Baumuster- prüfbescheinigung PTB 02 ATEX 1125
IECEx Zertifikat:	IECEx SEV 12.0001

Enlarging fittings nickel-plated brass increased safety Ex e II

Material:	Nickel-plated brass
O-ring :	NBR
Temperature range:	-40°C / +100°C
Protection class:	IP 68
Test standard:	IEC EN 60079-0 / IEC EN 60079-7
Category 2G:	Ex e II
Category 2D:	Ex tD A21 IP68
Zone:	Gas 1 and 2 / dust 21 and 22
Certificate:	EC-type test certificate PTB 02 ATEX 1125
IECEx Certificate:	IECEx SEV 12.0001



Erweiterung MS EX



Aussengewinde metrisch
Innengewinde metrisch
mit O-Ring

Outer thread metric
Inner thread metric
with O-ring

G	I	i info	1	H mm	L mm	i info	Art.-Nr. Art. No.	
M 8x1.25	M10x1.5	1	13	9	5	2	EX3600.08.10	50
M10x1.5	M12x1.5	1	15	9	5	2	EX3600.10.12	50
M12x1.5	M16x1.5	-	18	9	5	2	EX3600.12.17	50
M16x1.5	M20x1.5	-	24	10	5	-	EX3600.17.20	50
M20x1.5	M25x1.5	-	30	11.5	6	-	EX3600.20.25	25
M25x1.5	M32x1.5	-	36	14	7	-	EX3600.25.32	25
M32x1.5	M40x1.5	-	46	14	8	-	EX3600.32.40	25
M40x1.5	M50x1.5	-	55	16	8	-	EX3600.40.50	10
M50x1.5	M63x1.5	-	70	17	9	-	EX3600.50.63	10

1 = Metrisches Regelgewinde

1 = Metric coarse-pitch thread

2 = Zertifikat PTB 02 ATEX 1126X / IECEx SEV 12.0002X

2 = Certificate PTB 02 ATEX 1126X / IECEx SEV 12.0002X

Das Ineinanderschrauben mehrerer Reduktionen/Erweiterungen ist nach Norm nicht zulässig!

The norm interdicts to screw several reduction/enlarging fittings into each other!

Auf Anfrage lieferbar:

Available on request:

Erweiterungen Messing mit FMP-O-Ring für Einsatztemperaturen bis +200°C

Enlarging fittings nickel-plated brass with O-ring in FPM for high temperature applications up to +200°C

Erweiterungen Messing erhöhte Sicherheit Ex e II

Material:	Messing vernickelt
O-Ring :	NBR
Einsatztemperatur:	-40°C / +100°C
Schutzart:	IP 68
Prüfnorm:	IEC EN 60079-0 / IEC EN 60079-7
Kategorie 2G:	Ex e II
Kategorie 2D:	Ex tD A21 IP68
Zone:	Gas 1 und 2 / Staub 21 und 22
Zertifikat:	EG-Baumuster- prüfbescheinigung PTB 02 ATEX 1125
IECEx Zertifikat:	IECEx SEV 12.0001

Enlarging fittings nickel-plated brass increased safety Ex e II

Material:	Nickel-plated brass
O-ring :	NBR
Temperature range:	-40°C / +100°C
Protection class:	IP 68
Test standard:	IEC EN 60079-0 / IEC EN 60079-7
Category 2G:	Ex e II
Category 2D:	Ex tD A21 IP68
Zone:	Gas 1 and 2 / dust 21 and 22
Certificate:	EC-type test certificate PTB 02ATEX 1125
IECEx Certificate:	IECEx SEV 12.0001

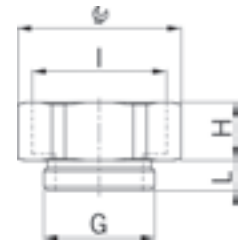

Erweiterung MS EX



Aussengewinde Pg
Innengewinde metrisch
mit O-Ring

Outer thread Pg
Inner thread metric
with O-ring

G	I		H mm	L mm	i info	Art.-Nr. Art. No.	
Pg 7	M12x1.5	15	9.0	6	2	EX3600.07.12	50
Pg 7	M16x1.5	18	9.0	6	2	EX3600.07.17	50
Pg 9	M16x1.5	18	9.5	6	-	EX3600.09.17	50
Pg 9	M20x1.5	24	10.5	6	-	EX3600.09.20	50
Pg 11	M20x1.5	24	10.5	6	-	EX3600.11.20	50
Pg 11	M25x1.5	30	11.5	6	-	EX3600.11.25	25
Pg 13	M20x1.5	24	10.5	6	-	EX3600.13.20	50
Pg 13	M25x1.5	30	11.5	6	-	EX3600.13.25	25
Pg 16	M25x1.5	30	11.5	6	-	EX3600.16.25	25
Pg 16	M32x1.5	36	13.5	6	-	EX3600.16.32	25
Pg 21	M32x1.5	36	14.0	7.5	-	EX3600.21.32	25
Pg 21	M40x1.5	46	14.0	7.5	-	EX3600.21.40	20
Pg 29	M40x1.5	46	14.0	8	-	EX3600.29.40	20
Pg 29	M50x1.5	55	16.0	8	-	EX3600.29.50	10
Pg 36	M50x1.5	55	16.0	8	-	EX3600.36.50	10
Pg 36	M63x1.5	70	17.0	8	-	EX3600.36.63	10
Pg 42	M63x1.5	70	17.0	10	-	EX3600.42.63	10
Pg 48	M63x1.5	70	17.0	11	-	EX3600.48.63	10



1 = Metrisches Regelgewinde

1 = Metric coarse-pitch thread

2 = Zertifikat PTB 02 ATEX 1126X / IECEx SEV 12.0002X

2 = Certificate PTB 02 ATEX 1126X / IECEx SEV 12.0002X

Das Ineinanderschrauben mehrerer Reduktionen/Erweiterungen ist nach Norm nicht zulässig!

The norm interdicts to screw several reduction/enlarging fittings into each other!

Auf Anfrage lieferbar:

Erweiterungen Messing mit FMP-O-Ring für Einsatztemperaturen bis +200°C

Available on request:

Enlarging fittings nickel-plated brass with O-ring in FPM for high temperature applications up to +200°C

Kurzes Anschlussgewinde metrisch | Short entry thread metric

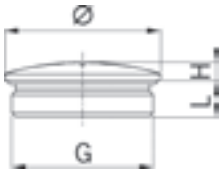

Verschlusschrauben Messing erhöhte Sicherheit Ex e II

Material:	Messing vernickelt
O-Ring :	NBR
Einsatztemperatur:	-40°C / +100°C
Schutzart:	IP 68
Prüfnorm:	IEC EN 60079-0 / IEC EN 60079-7
Kategorie 2G:	Ex e II
Kategorie 2D:	Ex tD A21 IP68
Zone:	Gas 1 und 2 / Staub 21 und 22
Zertifikat:	EG-Baumusterprüfbescheinigung PTB 02 ATEX 1125
IECEx Zertifikat:	IECEx SEV 12.0001

Locking plugs nickel-plated brass increased safety Ex e II

Material:	Nickel-plated brass
O-ring :	NBR
Temperature range:	-40°C / +100°C
Protection class:	IP 68
Test standard:	IEC EN 60079-0 / IEC EN 60079-7
Category 2G:	Ex e II
Category 2D:	Ex tD A21 IP68
Zone:	Gas 1 and 2 / dust 21 and 22
Certificate:	EC-type test certificate PTB 02 ATEX 1125
IECEx Certificate:	IECEx SEV 12.0001



Verschlusszapfen MS EX



mit O-Ring					with O-ring	
G	Ø mm	H mm	L mm	i info	Art.-Nr. Art. No.	
M8x1.25	10	3	5	1	EX8708.08	50
M10x1.5	12	3	5	1	EX8710.08	50
M12x1.5	14	3	5	-	EX8712.08	50
M16x1.5	19	3	5	-	EX8717.08	50
M20x1.5	24	3	6	-	EX8720.08	25
M25x1.5	28	4	7	-	EX8725.08	25
M32x1.5	35	4	8	-	EX8732.08	10
M40x1.5	45	6	8	-	EX8740.08	10
M50x1.5	55	6	9	-	EX8750.08	10
M63x1.5	70	6	10	-	EX8763.08	10

1 = Metrisches Regelgewinde 1 = Metric coarse-pitch thread

Auf Anfrage lieferbar: **Available on request:**

- Langes Anschlussgewinde - Long entry thread
- Verschlusschrauben aus rostfreiem Stahl A2 oder rostfreiem und säurebeständigem Stahl A4 mit kurzem oder langem Anschlussgewinde metrisch - Locking plugs in stainless steel A2 or acid-proof stainless steel A4 with short or long metric entry thread
- Verschlusschrauben mit FPM-O-Ring für Einsatztemperaturen bis +200°C - Locking plugs with O-ring in FPM for temperatures up to +200°C

Kurzes Anschlussgewinde Pg | Short entry thread Pg



Verschlusszapfen MS EX



mit O-Ring					with O-ring	
G	Ø mm	H mm	L mm		Art.-Nr. Art. No.	
Pg 7	14	3	5		EX8707.08	50
Pg 9	17	3	6		EX8709.08	50
Pg 11	20	3	6		EX8711.08	50
Pg 13	22	3	6.5		EX8713.08	50
Pg 16	24	3	6.5		EX8716.08	50
Pg 21	30	4	7		EX8721.08	10
Pg 29	39	4	8		EX8729.08	10
Pg 36	50	6	9		EX8736.08	10
Pg 48	65	6	10		EX8748.08	10

Auf Anfrage lieferbar: **Available on request:**

- Langes Anschlussgewinde - Long entry thread
- Verschlusschrauben aus rostfreiem Stahl A2 oder rostfreiem und säurebeständigem Stahl A4 mit kurzem oder langem Anschlussgewinde metrisch - Locking plugs in stainless steel A2 or acid-proof stainless steel A4 with short or long metric entry thread
- Verschlusschrauben mit FPM-O-Ring für Einsatztemperaturen bis +200°C - Locking plugs with O-ring in FPM for temperatures up to +200°C

Zubehör zu Kabelverschraubungen Messing und Kunststoff erhöhte Sicherheit Ex e II

Accessories for cable glands brass and synthetic for increased safety Ex e II

Anschlussgewinde metrisch | Entry thread metric

Verschlusschrauben Kunststoff erhöhte Sicherheit Ex e II

Synthetic locking plugs for increased safety Ex e II

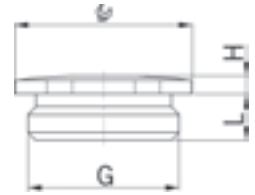

Material:	Polyamid
O-Ring :	NBR
Einsatztemperatur:	-20°C / +90°C
Schutzart:	IP 68
Prüfnorm:	IEC EN 60079-0 / IEC EN 60079-7
Kategorie 2G:	Ex e II
Kategorie 2D:	Ex tD A21 IP68
Zone:	Gas 1 und 2 / Staub 21 und 22
Zertifikat:	EG-Baumusterprüfbescheinigung DMT 03 ATEX E 049
IECEx Zertifikat:	IECEx BVS 07.0021

Material:	Polyamide
O-ring :	NBR
Temperature range:	-20°C / +90°C
Protection class:	IP 68
Test standard:	IEC EN 60079-0 / IEC EN 60079-7
Category 2G:	Ex e II
Category 2D:	Ex tD A21 IP68
Zone:	Gas 1 and 2 / dust 21 and 22
Certificate:	EC-type test certificate DMT 03 ATEX E 049
IECEx Certificate:	IECEx BVS 07.0021



Schwarz RAL 9005 mit O-Ring

Black RAL 9005 with O-ring

G			H mm	L mm	Art.-Nr. Art. No.	
M12x1.5	15	6	13.0	8.5	8841.12	100
M16x1.5	19	8	13.0	8.5	8841.17	100
M20x1.5	24	8	14.5	9.0	8841.20	100
M25x1.5	28	8	16.0	10.5	8841.25	100
M32x1.5	36	8	17.5	11.5	8841.32	100
M40x1.5	46	8	18.0	11.5	8841.40	50
M50x1.5	55	8	20.0	13.5	8841.50	25
M63x1.5	70	8	21.0	14.5	8841.63	10



Anschlussgewinde Pg | Entry thread Pg



Schwarz RAL 9005 mit O-Ring

Black RAL 9005 with O-ring

G			H mm	L mm	Art.-Nr. Art. No.	
Pg 7	15	6	13.0	8.5	8841.07	100
Pg 9	19	8	13.0	8.5	8841.09	100
Pg 11	24	8	14.5	9.0	8841.11	100
Pg 13	24	8	14.5	9.0	8841.13	100
Pg 16	28	8	16.0	10.5	8841.16	100
Pg 21	36	8	17.5	11.5	8841.21	100
Pg 29	46	8	18.0	11.5	8841.29	50
Pg 36	55	8	20.0	13.5	8841.36	25
Pg 42	60	8	20.0	13.5	8841.42	10
Pg 48	70	8	21.0	14.5	8841.48	10



AGRO Kombi-Schlauchverschraubung aus Messing

AGRO Combination conduit glands nickel-plated brass

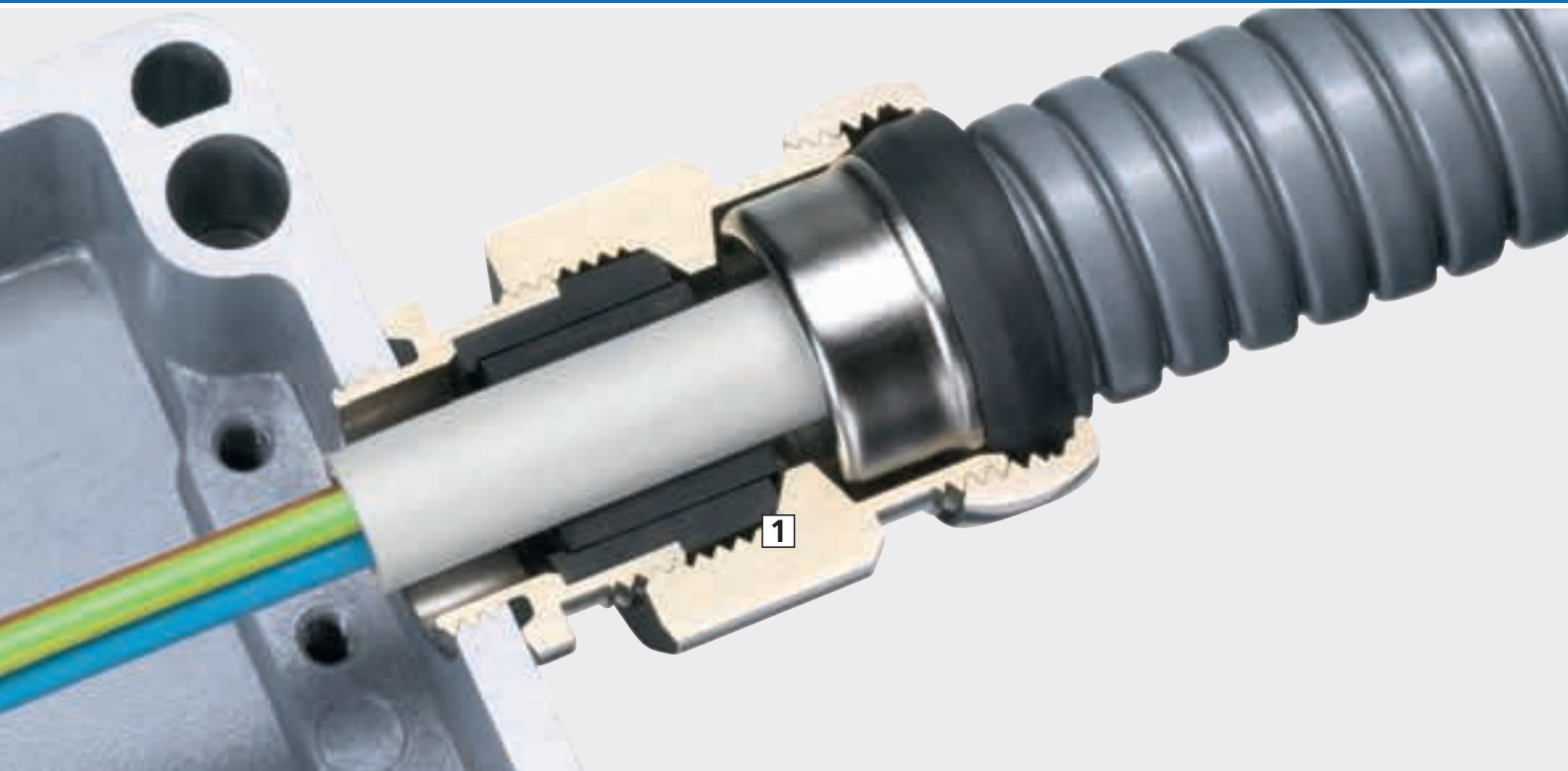

AGRO Kombi-Schlauchverschraubungen sind eine optimale Lösung, wenn Sie Kabel in einem Schutzschlauch in ein Gehäuse einführen wollen und gleichzeitig eine sichere Abdichtung und Zugentlastung des Kabels möchten.

1 Dichtheit

Mit der integrierten Kabelverschraubung erzielen Sie eine hervorragende Dichtheit (IP 68) im Innenbereich des Schutzschlauchs. So verhindern Sie das Eindringen von Flüssigkeiten und Kondenswasser.

Integrierte EMV Kabelverschraubung

Die Kombi-Schlauchverschraubung gibt es auch als kombinierte Variante für geschirmte Kabel.

Kommen Kombi-Schlauchverschraubungen in **Bahnapplikationen** zum Einsatz - etwa weil Kabel in Schutzschläuchen geführt werden, um sie vor Schlägen oder Manipulation zu schützen - so gelten für sie die selben Anforderungen wie für Kabelverschraubungen: sie müssen mit einem Dichteinsatz aus Spezial-TPE gemäss **EN 45545** bestückt werden.

AGRO Combination conduit glands are an optimal solution if you want to feed cables inside a conduit into an enclosure and at the same time want a secure seal and strain relief for the cables.

1 Sealing capability

The integrated cable gland achieves excellent sealing (IP 68) inside the conduit. In this way, you make certain that water and condensate cannot make its way inside.

Integrated EMC cable gland

The combination conduit gland is also available in a special version for shielded cables.

In cases where combination conduit glands are used for **railway applications** - for instance when cables are laid in conduits in order to protect them from impacts or manipulation - the same requirements apply as for cable glands: the combination conduit glands must be equipped with a sealing insert made of special TPE according to the requirements of **EN 45545**.



<p>AGRO Kombi-Schlauchverschraubung Progress® Messing mit integrierter Kabelverschraubung AGRO Combination conduit glands Progress® nickel-plated brass with integrated cable gland</p>	 <p>152 - 154</p>	1
<p>AGRO Adapter Progress® Messing mit integrierter Kabelverschraubung AGRO Adapter Progress® nickel-plated brass with integrated cable gland</p>	 <p>155 - 156</p>	2
<p>AGRO Kombi-Schlauchverschraubung Progress® EMV Messing mit integrierter Kabelverschraubung AGRO Combination conduit glands Progress® EMC nickel-plated brass with integrated cable gland</p>	 <p>157 - 159</p>	3
<p>AGRO Adapter Progress® Messing mit integrierter EMV-Kabelverschraubung AGRO Adapters Progress® nickel-plated brass with integrated EMC cable gland</p>	 <p>160 - 161</p>	4
<p>AGRO Kombi-EMV-Schlauchverschraubung für Kupfer-Hohlgeflechte AGRO Combination EMC conduit gland for copper braidings</p>	 <p>162</p>	5
<p>Zubehör zu Schlauchverschraubungen Conduit glands accessories</p>	 <p>163</p>	6

Kurzes Anschlussgewinde metrisch | Short entry thread metric

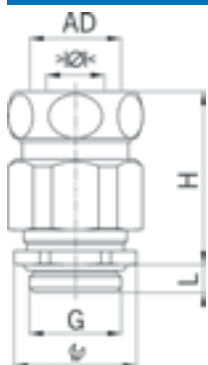

Material: Messing vernickelt
 Dichtung: TPE
 O-Ring : NBR
 Zugentlastung: Ausführung A
 Einsatztemperatur: -40°C / +100°C
 Schutzart: Kabelverschraubung IP 68
 Hinweis: Die Schutzart des Schlauchanschlusses ist abhängig von der Wahl des Schlauchtyps

Material: Nickel-plated brass
 Seal: TPE
 O-ring : NBR
 Strain relief: Version A
 Temperature range: -40°C / +100°C
 Protection class: Cable gland IP 68

Note: The protection class of the conduit fitting depends on the selection of the type of conduit



Progress MS Kombi



Für Schlauchanschluss AD mm
 Zweiteiliger Dichteinsatz
 nicht durchgehend isolierend

Connector for tubing with AD mm
 Two-piece sealing insert
 not overall length insulated

G	AD mm	>Ø< min mm	>Ø< max mm		H mm	L mm	Art.-Nr. Art. No.	
M12x1.5	10	5.0	6.5	15/17	33	5	1700.12.10	50
M16x1.5	14	6.0	10.5	18/21	38	5	1700.17.14	50
M20x1.5	17	8.0	15.0	24/25	38	6	1700.20.17	25
M20x1.5	19	8.0	15.0	24/27	39	6	1700.20.19	25
M20x1.5	21	8.0	15.0	24/29	39	6	1700.20.21	25
M25x1.5	21	12.5	20.5	30/29	43	7	1700.25.21	25
M25x1.5	27	12.5	20.5	30/36	50	7	1700.25.27	25
M32x1.5	27	17.0	25.5	36/36	52	8	1700.32.27	25
M40x1.5	36	24.0	33.0	46/45	56	8	1700.40.36	10
M50x1.5	45	33.0	42.0	55/54	60	9	1700.50.45	10
M63x1.5	56	40.0	52.0	70/66	67	10	1700.63.56	5

Je nach Schlauchtyp muss die passende Stabilisierungshülse separat bestellt werden.

Depending on the type of conduit, the stabilising bush must be ordered separately.

Erhältlich mit Dichteinsatz gemäss EN 45545. Bei Anfragen oder Bestellung bitte ein F vor die Artikelnummer setzen.

Available with sealing inserts conformity with EN 45545. When placing an inquiry, prefix the article number by the capital F.

Progress MS Kombi



Für Schlauchanschluss AD Zoll
 Zweiteiliger Dichteinsatz
 nicht durchgehend isolierend

Connector for tubing with AD in inches
 Two-piece sealing insert
 not overall length insulated

G	AD mm	>Ø< min mm	>Ø< max mm		H mm	L mm	Art.-Nr. Art. No.	
M12x1.5	1/4"	5.0	6.5	15/19	35	5	1700.12.1/4	50
M20x1.5	3/8"	8.0	15.0	24/27	42	6	1700.20.3/8	25
M20x1.5	1/2"	8.0	15.0	24/29	38	6	1700.20.1/2	25
M25x1.5	3/4"	12.5	20.5	30/36	52	7	1700.25.3/4	25
M32x1.5	1"	17.0	25.5	36/45	55	8	1700.32.1	25
M40x1.5	1 1/4"	24.0	33.0	46/54	62	8	1700.40.11/4	10
M63x1.5	2"	40.0	52.0	70/70	74	10	1700.63.2	5

Je nach Schlauchtyp muss die passende Stabilisierungshülse separat bestellt werden.

Depending on the type of conduit, the stabilising bush must be ordered separately.

Erhältlich mit Dichteinsatz gemäss EN 45545. Bei Anfragen oder Bestellung bitte ein F vor die Artikelnummer setzen.

Available with sealing inserts conformity with EN 45545. When placing an inquiry, prefix the article number by the capital F.

AGRO Kombi-Schlauchverschraubung Progress® Messing mit integrierter Kabelverschraubung

AGRO combination conduit glands Progress® nickel-plated brass with integrated cable gland

Langes Anschlussgewinde metrisch | Long entry thread metric

Material: Messing vernickelt
 Dichtung: TPE
 O-Ring : NBR
 Zugentlastung: Ausführung A
 Einsatztemperatur: -40°C / +100°C
 Schutzart: Kabelverschraubung IP 68
 Hinweis: Die Schutzart des Schlauchanschlusses ist abhängig von der Wahl des Schlauchtyps

Material: Nickel-plated brass
 Seal: TPE
 O-ring : NBR
 Strain relief: Version A
 Temperature range: -40°C / +100°C
 Protection class: Cable gland IP 68
 Note: The protection class of the conduit fitting depends on the selection of the type of conduit

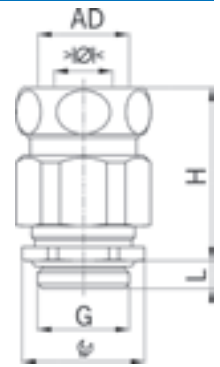

Progress MS Kombi



Für Schlauchanschluss AD mm
 Zweiteiliger Dichteinsatz
 durchgehend isolierend

Connector for tubing with AD mm
 Two-piece sealing insert
 overall length insulated

G	AD mm	>Ø< min mm	>Ø< max mm		H mm	L mm	Art.-Nr. Art. No.	
M12x1.5	10	5.0	6.5	15/17	33	10	1710.60.12.10	50
M16x1.5	14	6.0	10.5	18/21	38	10	1710.60.17.14	50
M20x1.5	17	8.0	14.5	24/25	38	10	1710.60.20.17	25
M20x1.5	19	8.0	14.5	24/27	39	10	1710.60.20.19	25
M20x1.5	21	8.0	14.5	24/29	39	10	1710.60.20.21	25
M25x1.5	21	12.5	19.0	30/29	43	11	1710.60.25.21	25
M25x1.5	27	12.5	19.0	30/36	50	11	1710.60.25.27	25
M32x1.5	27	17.0	25.5	36/36	52	13	1710.60.32.27	25
M40x1.5	36	24.0	33.0	46/45	56	13	1710.60.40.36	10
M50x1.5	45	33.0	42.0	55/54	60	14	1710.60.50.45	10
M63x1.5	56	40.0	52.0	70/66	67	14	1710.60.63.56	5



Je nach Schlauchttyp muss die passende Stabilisierungshülse separat bestellt werden.

Depending on the type of conduit, the stabilising bush must be ordered separately.

Erhältlich mit Dichteinsatz gemäss EN 45545. Bei Anfragen oder Bestellung bitte ein F vor die Artikelnummer setzen.

Available with sealing inserts conformity with EN 45545. When placing an inquiry, prefix the article number by the capital F.

Progress MS Kombi



Für Schlauchanschluss AD Zoll
 Zweiteiliger Dichteinsatz
 durchgehend isolierend

Connector for tubing with AD in inches
 Two-piece sealing insert
 overall length insulated

G	AD mm	>Ø< min mm	>Ø< max mm		H mm	L mm	Art.-Nr. Art. No.	
M12x1.5	1/4"	5.0	6.5	15/19	35	10	1710.60.12.1/4	50
M20x1.5	3/8"	8.0	14.5	24/27	42	10	1710.60.20.3/8	25
M20x1.5	1/2"	8.0	14.5	24/29	38	10	1710.60.20.1/2	25
M25x1.5	3/4"	12.5	19.0	30/36	52	11	1710.60.25.3/4	25
M32x1.5	1"	17.0	19.0	36/45	55	13	1710.60.32.1	25
M40x1.5	1 1/4"	24.0	33.0	46/54	62	13	1710.60.40.11/4	10
M63x1.5	2"	40.0	52.0	70/70	74	14	1710.60.63.2	5



Je nach Schlauchttyp muss die passende Stabilisierungshülse separat bestellt werden.

Depending on the type of conduit, the stabilising bush must be ordered separately.

Erhältlich mit Dichteinsatz gemäss EN 45545. Bei Anfragen oder Bestellung bitte ein F vor die Artikelnummer setzen.

Available with sealing inserts conformity with EN 45545. When placing an inquiry, prefix the article number by the capital F.

AGRO Kombi-Schlauchverschraubung Progress® Messing mit integrierter Kabelverschraubung

AGRO combination conduit glands Progress® nickel-plated brass with integrated cable gland

Kurzes Anschlussgewinde Pg | Short entry thread Pg

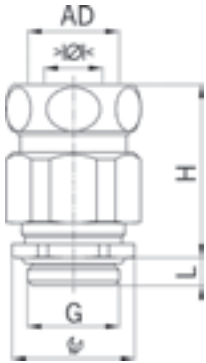

Material: Messing vernickelt
 Dichtung: TPE
 O-Ring : NBR
 Einsatztemperatur: -40°C / +100°C
 Schutzart: Kabelverschraubung IP 68
 Hinweis: Die Schutzart des Schlauchanschlusses ist abhängig von der Wahl des Schlauchtyps

Material: Nickel-plated brass
 Seal: TPE
 O-ring : NBR
 Temperature range: -40°C / +100°C
 Protection class: Cable gland IP 68

Note: The protection class of the conduit fitting depends on the selection of the type of conduit



Progress MS Kombi

Für Schlauchanschluss AD mm
 Zweiteiliger Dichteinsatz
 nicht durchgehend isolierend

Connector for tubing with AD mm
 Two-piece sealing insert
 not overall length insulated

G	AD mm	>Ø< min mm	>Ø< max mm		H mm	L mm	Art.-Nr. Art. No.	
Pg 7	10	5.0	6.5	15/17	33	6	1700.07.10	50
Pg 9	14	6.0	10.5	18/21	38	6	1700.09.14	50
Pg 11	14	5.5	12.0	21/21	39	6	1700.11.14	50
Pg 11	17	5.5	12.0	21/25	39	6	1700.11.17	50
Pg 13	19	8.0	15.0	24/27	39	6	1700.13.19	25
Pg 16	17	8.0	15.0	24/25	38	6	1700.16.17	25
Pg 16	21	8.0	15.0	24/29	39	6	1700.16.21	25
Pg 21	27	12.5	20.5	30/36	50	7.5	1700.21.27	25
Pg 29	36	19.0	27.5	38/45	55	8	1700.29.36	25
Pg 36	45	26.0	35.0	50/54	60	8	1700.36.45	10
Pg 42	45	33.0	42.0	55/54	60	10	1700.42.45	10
Pg 48	56	37.0	49.0	65/66	67	11	1700.48.56	10

Je nach Schlauchtyp muss die passende Stabilisierungshülse separat bestellt werden.

Depending on the type of conduit, the stabilising bush must be ordered separately.

Erhältlich mit Dichteinsatz gemäss EN 45545. Bei Anfragen oder Bestellung bitte ein F vor die Artikelnummer setzen.

Available with sealing inserts conformity with EN 45545. When placing an inquiry, prefix the article number by the capital F.

Langes Anschlussgewinde Pg | Long entry thread Pg



Progress MS Kombi

Für Schlauchanschluss AD mm
 Zweiteiliger Dichteinsatz
 durchgehend isolierend

Connector for tubing with AD mm
 Two-piece sealing insert
 overall length insulated

G	AD mm	>Ø< min mm	>Ø< max mm		H mm	L mm	Art.-Nr. Art. No.	
Pg 7	10	5.0	6.5	15/17	33	10	1710.60.07.10	50
Pg 9	14	6.0	10.5	18/21	38	10	1710.60.09.14	50
Pg 11	14	5.5	12.0	21/21	39	10	1710.60.11.14	50
Pg 11	17	5.5	12.0	21/25	39	10	1710.60.11.17	50
Pg 13	19	8.0	14.5	24/27	39	10	1710.60.13.19	25
Pg 16	17	8.0	14.5	24/25	38	10	1710.60.16.17	25
Pg 16	21	8.0	14.5	24/29	39	10	1710.60.16.21	25
Pg 21	27	12.5	19.0	30/36	50	12	1710.60.21.27	25
Pg 29	36	19.0	27.5	38/45	55	12	1710.60.29.36	25
Pg 36	45	26.0	35.0	50/54	60	15	1710.60.36.45	10
Pg 42	45	33.0	42.0	55/54	60	15	1710.60.42.45	10
Pg 48	56	37.0	49.0	65/66	67	15	1710.60.48.56	10

Je nach Schlauchtyp muss die passende Stabilisierungshülse separat bestellt werden.

Depending on the type of conduit, the stabilising bush must be ordered separately.

Erhältlich mit Dichteinsatz gemäss EN 45545. Bei Anfragen oder Bestellung bitte ein F vor die Artikelnummer setzen.

Available with sealing inserts conformity with EN 45545. When placing an inquiry, prefix the article number by the capital F.

AGRO Adapter Progress® Messing mit integrierter Kabelverschraubung

AGRO Adapter Progress® nickel-plated brass with integrated cable gland

Langes Anschlussgewinde metrisch | Long entry thread metric

Material: Messing vernickelt
 Dichtung: TPE
 O-Ring : NBR
 Zugentlastung: Ausführung A
 Einsatztemperatur: -40°C / +100°C
 Schutzart: Kabelverschraubung IP 68
 Hinweis: Die Schutzart ist abhängig von der Wahl des Anschlusssteils

Material: Nickel-plated brass
 Seal: TPE
 O-ring : NBR
 Strain relief: Version A
 Temperature range: -40°C / +100°C
 Protection class: Cable gland IP 68
 Note: The protection class depends on the selection of the connector

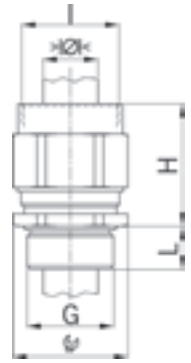

Progress MS Adapter



Einteiliger Dichteinsatz durchgehend isolierend

One-piece sealing insert overall length insulated

G	I	> Ø < min mm	> Ø < max mm	IC	H mm	L mm	i info	Art.-Nr. Art. No.	
M10x1.5	M10x1.5	4.0	6.0	13	30	10	1	1165.10	50
M12x1.5	M12x1.5	5.0	6.5	15	32	10	-	1165.12	50

1 = Metrisches Regelgewinde

1 = Metric coarse-pitch thread

Erhältlich mit Dichteinsatz gemäss EN 45545. Bei Anfragen oder Bestellung bitte ein F vor die Artikelnummer setzen.

Available with sealing inserts conformity with EN 45545. When placing an inquiry, prefix the article number by the capital F.



Progress MS Adapter



Zweiteiliger Dichteinsatz durchgehend isolierend

Two-piece sealing insert overall length insulated

G	I	> Ø < min mm	> Ø < max mm	IC	H mm	L mm	Art.-Nr. Art. No.	
M16x1.5	M16x1.5	6.0	10.5	18	35	10	1165.17	50
M20x1.5	M20x1.5	8.0	14.5	24	36	10	1165.20	25
M25x1.5	M25x1.5	12.5	19.0	30	41	11	1165.25	25
M32x1.5	M32x1.5	17.0	25.5	36	46	13	1165.32	25
M40x1.5	M40x1.5	24.0	33.0	46	48	13	1165.40	10
M50x1.5	M50x1.5	33.0	42.0	55	53	14	1165.50	5
M63x1.5	M63x1.5	40.0	52.0	70	56	14	1165.63	5

Erhältlich mit Dichteinsatz gemäss EN 45545. Bei Anfragen oder Bestellung bitte ein F vor die Artikelnummer setzen.

Available with sealing inserts conformity with EN 45545. When placing an inquiry, prefix the article number by the capital F.



AGRO Adapter Progress® Messing mit integrierter Kabelverschraubung

AGRO Adapter Progress® nickel-plated brass with integrated cable gland

Langes Anschlussgewinde Pg | Long entry thread Pg

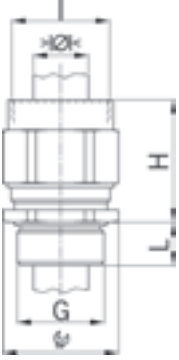

Material:	Messing vernickelt	Material:	Nickel-plated brass
Dichtung:	TPE	Seal:	TPE
O-Ring :	NBR	O-ring :	NBR
Einsatztemperatur:	-40°C / +100°C	Temperature range:	-40°C / +100°C
Schutzart:	Kabelverschraubung IP 68	Protection class:	Cable gland IP 68
Hinweis:	Die Schutzart ist abhängig von der Wahl des Anschlusssteils	Note:	The protection class depends on the selection of the connector

Progress MS Adapter



Einteiliger Dichteinsatz
durchgehend isolierend

One-piece sealing insert
overall length insulated

G	I	>Ø< min mm	>Ø< max mm		H mm	L mm	Art.-Nr. Art. No.	
Pg 7	Pg 7	5.0	6.5	15	30	10	1165.07	50

Erhältlich mit Dichteinsatz gemäss EN 45545. Bei Anfragen oder Bestellung bitte ein F vor die Artikelnummer setzen.

Available with sealing inserts conformity with EN 45545. When placing an inquiry, prefix the article number by the capital F.

Progress MS Adapter



Zweiteiliger Dichteinsatz
durchgehend isolierend

Two-piece sealing insert
overall length insulated

G	I	>Ø< min mm	>Ø< max mm		H mm	L mm	Art.-Nr. Art. No.	
Pg 9	Pg 9	6.0	10.5	18	35	10	1165.09	50
Pg 11	Pg 11	5.5	12.0	21	36	10	1165.11	50
Pg 13	Pg 13	8.0	14.5	24	36	10	1165.13	25
Pg 16	Pg 16	8.0	14.5	24	37	10	1165.16	25
Pg 21	Pg 21	12.5	19.0	30	42	12	1165.21	25
Pg 29	Pg 29	19.0	27.5	38/40	45	12	1165.29	10
Pg 36	Pg 36	26.0	35.0	50	52	15	1165.36	10
Pg 48	Pg 48	37.0	49.0	65	56	15	1165.48	5

Erhältlich mit Dichteinsatz gemäss EN 45545. Bei Anfragen oder Bestellung bitte ein F vor die Artikelnummer setzen.

Available with sealing inserts conformity with EN 45545. When placing an inquiry, prefix the article number by the capital F.

AGRO Kombi-Schlauchverschraubung Progress® EMV Messing mit integrierter Kabelverschraubung

AGRO combination conduit glands Progress® EMC nickel-plated brass with integrated cable gland

Langes Anschlussgewinde metrisch | Long entry thread metric

Material:	Messing vernickelt	Material:	Nickel-plated brass
Dichtung:	TPE	Seal:	TPE
O-Ring :	NBR	O-ring :	NBR
Zugentlastung:	Ausführung A	Strain relief:	Version A
Einsatztemperatur:	-40°C / +100°C	Temperature range:	-40°C / +100°C
Schutzart:	Kabelverschraubung IP 68	Protection class:	Cable gland IP 68
Hinweis:	Die Schutzart des Schlauchanschlusses ist abhängig von der Wahl des Schlauchtyps	Note:	The protection class of the conduit fitting de- pends on the selection of the type of conduit
Eigenschaften:	Sehr guter Schirmkontakt über die Kontakthülse bei in der Kabelver- schraubung endendem Schirmgeflecht	Properties:	Excellent shield contact through the contact sleeve with the braided shield terminating in the screwed cable gland

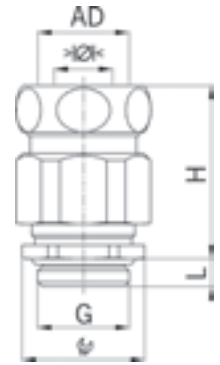

Progress MS Kombi EMC



Einteiliger Dichteinsatz
nicht durchgehend isolierend

One-piece sealing insert
not overall length insulated

G	AD mm	>Ø< min mm	>Ø< max mm		H mm	L mm	Art.-Nr. Art. No.	
M12x1.5	10	4.5	6.0	15-17	35	10	1710.80.12.060.1	25
M16x1.5	14	6.0	8.0	18/21	40	10	1710.80.17.080.1	25
M16x1.5	14	8.0	10.0	18/21	40	10	1710.80.17.100.1	25
M20x1.5	17	8.0	11.0	24/25	42	10	1710.80.20.110.1	25
M20x1.5	17	11.0	14.0	24/25	42	10	1710.80.20.140.1	25
M20x1.5	19	8.0	11.0	24/27	43	10	1710.80.20.110.2	25
M20x1.5	19	11.0	14.0	24/27	43	10	1710.80.20.140.2	25
M25x1.5	21	13.0	16.0	30/29	48	11	1710.80.25.160.1	25
M25x1.5	27	16.0	19.0	30/36	52	11	1710.80.25.190.1	25
M32x1.5	27	18.0	21.0	36/36	55	13	1710.80.32.210.1	10
M32x1.5	27	21.0	25.0	36/36	55	13	1710.80.32.250.1	10
M40x1.5	36	24.0	28.5	46/45	60	13	1710.80.40.285.1	10
M40x1.5	36	28.5	32.0	46/45	60	13	1710.80.40.320.1	10
M50x1.5	45	33.0	37.0	55/54	62	14	1710.80.50.370.1	5
M50x1.5	45	37.0	41.0	55/54	62	14	1710.80.50.410.1	5
M63x1.5	56	40.0	46.0	70/66	69	14	1710.80.63.460.1	5
M63x1.5	56	46.0	50.0	70/66	69	14	1710.80.63.500.1	5



Je nach Schlauchtyp muss die passende Stabilisierungshülse separat bestellt werden.

Depending on the type of conduit, the stabilising bush must be ordered separately.

Erhältlich mit Dichteinsatz gemäss EN 45545. Bei Anfragen oder Bestellung bitte ein F vor die Artikelnummer setzen.

Available with sealing inserts conformity with EN 45545. When placing an inquiry, prefix the article number by the capital F.

Langes Anschlussgewinde metrisch | Long entry thread metric

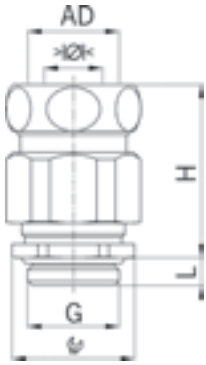

Material:	Messing vernickelt	Material:	Nickel-plated brass
Dichtung:	TPE	Seal:	TPE
O-Ring :	NBR	O-ring :	NBR
Zugentlastung:	Ausführung A	Strain relief:	Version A
Einsatztemperatur:	-40°C / +100°C	Temperature range:	-40°C / +100°C
Schutzart:	Kabelverschraubung IP 68	Protection class:	Cable gland IP 68
Hinweis:	Die Schutzart des Schlauchanschlusses ist abhängig von der Wahl des Schlauchtyps	Note:	The protection class of the conduit fitting depends on the selection of the type of conduit
Eigenschaften:	Sehr guter Schirmkontakt über die Kontakthülse bei in der Kabelverschraubung endendem Schirmgeflecht	Properties:	Excellent shield contact through the contact sleeve with the braided shield terminating in the screwed cable gland

Progress MS Kombi EMC



Einteiliger Dichteinsatz nicht durchgehend isolierend							One-piece sealing insert not overall length insulated	
G	AD mm	>Ø< min mm	>Ø< max mm		H mm	L mm	Art.-Nr. Art. No.	
M12x1.5	1/4"	4.5	6.0	15/19	35	10	1710.80.12.060.2	25
M16x1.5	5/16"	6.0	8.0	18/21	38	10	1710.80.17.080.2	25
M16x1.5	5/16"	8.0	10.0	18/21	38	10	1710.80.17.100.2	25
M20x1.5	3/8"	8.0	11.0	24/27	42	10	1710.80.20.110.3	25
M20x1.5	1/2"	8.0	11.0	24/29	38	10	1710.80.20.110.4	25
M20x1.5	1/2"	11.0	14.0	24/29	38	10	1710.80.20.140.4	25
M25x1.5	3/4"	13.0	16.0	30/36	52	11	1710.80.25.160.2	25
M25x1.5	3/4"	16.0	19.0	30/36	52	11	1710.80.25.190.2	25
M32x1.5	1"	18.0	21.0	36/45	55	13	1710.80.32.210.2	10
M32x1.5	1"	21.0	25.0	36/45	55	13	1710.80.32.250.2	10
M40x1.5	1 1/4"	24.0	28.5	46/54	62	13	1710.80.40.285.2	10
M40x1.5	1 1/4"	28.5	32.0	46/54	62	13	1710.80.40.320.2	10
M63x1.5	2"	40.0	46.0	70/70	74	14	1710.80.63.460.2	5
M63x1.5	2"	46.0	50.0	70/70	74	14	1710.80.63.500.2	5

Je nach Schlauchtyp muss die passende Stabilisierungshülse separat bestellt werden. Depending on the type of conduit, the stabilising bush must be ordered separately.

Erhältlich mit Dichteinsatz gemäss EN 45545. Bei Anfragen oder Bestellung bitte ein F vor die Artikelnummer setzen. Available with sealing inserts conformity with EN 45545. When placing an inquiry, prefix the article number by the capital F.

Langes Anschlussgewinde Pg | Long entry thread Pg

Material:	Messing vernickelt	Material:	Nickel-plated brass
Dichtung:	TPE	Seal:	TPE
O-Ring :	NBR	O-ring :	NBR
Einsatztemperatur:	-40°C / +100°C	Temperature range:	-40°C / +100°C
Schutzart:	Kabelverschraubung IP 68	Protection class:	Cable gland IP 68
Hinweis:	Die Schutzart des Schlauchanschlusses ist abhängig von der Wahl des Schlauchtyps	Note:	The protection class of the conduit fitting de- pends on the selection of the type of conduit
Eigenschaften:	Sehr guter Schirmkontakt über die Kontakthülse bei in der Kabelver- schraubung endendem Schirmgeflecht	Properties:	Excellent shield contact through the contact sleeve with the braided shield terminating in the screwed cable gland

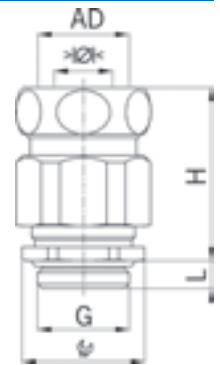

Progress MS Kombi EMC



Einteiliger Dichteinsatz nicht durchgehend isolierend		One-piece sealing insert not overall length insulated				Art.-Nr. Art. No.		
G	AD mm	> Ø < min mm	> Ø < max mm		H mm	L mm		
Pg 7	10	4.5	6.0	15/17	35	10	1710.80.07.060.1	25
Pg 9	14	6.0	8.0	18/21	40	10	1710.80.09.080.1	25
Pg 9	14	8.0	10.0	18/21	40	10	1710.80.09.100.1	25
Pg 11	17	8.5	12.0	21/25	41	10	1710.80.11.120.1	25
Pg 11	17	5.5	8.5	21/25	41	10	1710.80.11.085.1	25
Pg 13	19	8.0	11.0	24/27	42	10	1710.80.13.110.1	25
Pg 13	19	11.0	14.0	24/27	42	10	1710.80.13.140.1	25
Pg 16	21	8.0	11.0	24/29	43	10	1710.80.16.110.1	25
Pg 16	21	11.0	14.0	24/29	43	10	1710.80.16.140.1	25
Pg 21	27	13.0	16.0	30/36	55	12	1710.80.21.160.1	10
Pg 21	27	16.0	19.0	30/36	55	12	1710.80.21.190.1	10
Pg 29	36	19.0	23.0	38/45	57	12	1710.80.29.230.1	10
Pg 29	36	23.0	25.5	38/45	57	12	1710.80.29.255.1	10
Pg 36	45	25.0	30.5	50/54	62	15	1710.80.36.305.1	5
Pg 36	45	30.5	35.0	50/54	62	15	1710.80.36.350.1	5
Pg 42	45	33.0	37.0	55/54	62	15	1710.80.42.370.1	5
Pg 42	45	37.0	41.0	55/54	62	15	1710.80.42.410.1	5
Pg 48	56	39.0	43.0	65/66	69	15	1710.80.48.430.1	5
Pg 48	56	43.0	46.5	65/66	69	15	1710.80.48.465.1	5



Je nach Schlauchtyp muss die passende Stabilisierungshülse separat bestellt werden. Depending on the type of conduit, the stabilising bush must be ordered separately.

Erhältlich mit Dichteinsatz gemäss EN 45545. Bei Anfragen oder Bestellung bitte ein F vor die Artikelnummer setzen. Available with sealing inserts conformity with EN 45545. When placing an inquiry, prefix the article number by the capital F.

AGRO Adapter Progress® Messing mit integrierter EMV-Kabelverschraubung

AGRO Adapters Progress® nickel-plated brass with integrated EMC cable gland

Langes Anschlussgewinde metrisch | Long entry thread metric

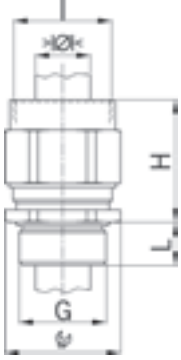

Material: Messing vernickelt
 Dichtung: TPE
 O-Ring : NBR
 Zugentlastung: Ausführung A
 Einsatztemperatur: -40°C / +100°C
 Schutzart: Kabelverschraubung IP 68
 Hinweis: Die Schutzart ist abhängig von der Wahl des Anschlusssteils

Material: Nickel-plated brass
 Seal: TPE
 O-ring : NBR
 Strain relief: Version A
 Temperature range: -40°C / +100°C
 Protection class: Cable gland IP 68
 Note: The protection class depends on the selection of the connector



Progress MS Kombi EMC

Einteiliger Dichteinsatz
 nicht durchgehend isolierend

One-piece sealing insert
 not overall length insulated



G	I	> Ø < min mm	> Ø < max mm		H mm	L mm	i info	Art.-Nr. Art. No.	
M10x1.5	M10x1.5	3.0	4.0	13	32	10	1	1165.80.10.040	50
M10x1.5	M10x1.5	4.0	6.0	13	32	10	1	1165.80.10.060	50
M12x1.5	M12x1.5	4.5	6.0	15	34	10	-	1165.80.12.060	50
M12x1.5	M12x1.5	6.0	7.5	15	34	10	-	1165.80.12.075	50
M16x1.5	M16x1.5	6.0	8.0	18	38	10	-	1165.80.17.080	50
M16x1.5	M16x1.5	8.0	10.0	18	38	10	-	1165.80.17.100	50
M20x1.5	M20x1.5	8.0	11.0	24	40	10	-	1165.80.20.110	25
M20x1.5	M20x1.5	11.0	14.0	24	40	10	-	1165.80.20.140	25
M25x1.5	M25x1.5	13.0	16.0	30	46	11	-	1165.80.25.160	25
M25x1.5	M25x1.5	16.0	19.0	30	46	11	-	1165.80.25.190	25
M32x1.5	M32x1.5	18.0	21.0	36	49	13	-	1165.80.32.210	10
M32x1.5	M32x1.5	21.0	25.0	36	49	13	-	1165.80.32.250	10
M40x1.5	M40x1.5	24.0	28.5	46	51	13	-	1165.80.40.285	5
M40x1.5	M40x1.5	28.5	32.0	46	51	13	-	1165.80.40.320	5
M50x1.5	M50x1.5	33.0	37.0	55	55	14	-	1165.80.50.370	5
M50x1.5	M50x1.5	37.0	41.0	55	55	14	-	1165.80.50.410	5
M63x1.5	M63x1.5	40.0	46.0	70	59	14	-	1165.80.63.460	5
M63x1.5	M63x1.5	46.0	50.0	70	59	14	-	1165.80.63.500	5

1 = Metrisches Regelgewinde

1 = Metric coarse-pitch thread

Erhältlich mit Dichteinsatz gemäss EN 45545. Bei Anfragen oder Bestellung bitte ein F vor die Artikelnummer setzen.

Available with sealing inserts conformity with EN 45545. When placing an inquiry, prefix the article number by the capital F.

AGRO Adapter Progress® Messing mit integrierter EMV-Kabelverschraubung

AGRO Adapters Progress® nickel-plated brass with integrated EMC cable gland

Langes Anschlussgewinde Pg | Long entry thread Pg

Material: Messing vernickelt
 Dichtung: TPE
 O-Ring : NBR
 Einsatztemperatur: -40°C / +100°C
 Schutzart: Kabelverschraubung IP 68
 Hinweis: Die Schutzart ist abhängig von der Wahl des Anschlusssteils

Material: Nickel-plated brass
 Seal: TPE
 O-ring : NBR
 Temperature range: -40°C / +100°C
 Protection class: Cable gland IP 68
 Note: The protection class depends on the selection of the connector

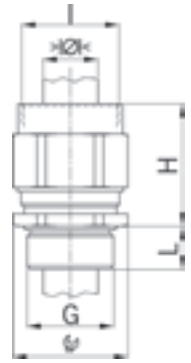

Progress MS Kombi EMC



Einteiliger Dichteinsatz
 nicht durchgehend isolierend

One-piece sealing insert
 not overall length insulated

G	I	> Ø < min mm	> Ø < max mm		H mm	L mm	Art.-Nr. Art. No.	
Pg 7	Pg 7	4.0	6.0	15	31	10	1165.80.07.060	50
Pg 7	Pg 7	6.0	7.5	15	31	10	1165.80.07.075	50
Pg 9	Pg 9	6.0	8.0	18	38	10	1165.80.09.080	50
Pg 9	Pg 9	8.0	10.0	18	38	10	1165.80.09.100	50
Pg 11	Pg 11	5.5	8.5	21	38	10	1165.80.11.085	50
Pg 11	Pg 11	8.5	12.0	21	38	10	1165.80.11.120	50
Pg 13	Pg 13	8.0	11.0	24	40	10	1165.80.13.110	25
Pg 13	Pg 13	11.0	14.0	24	40	10	1165.80.13.140	25
Pg 16	Pg 16	8.0	11.0	24	41	10	1165.80.16.110	25
Pg 16	Pg 16	11.0	14.0	24	41	10	1165.80.16.140	25
Pg 21	Pg 21	13.0	16.0	30	47	12	1165.80.21.160	10
Pg 21	Pg 21	16.0	19.0	30	47	12	1165.80.21.190	10
Pg 29	Pg 29	19.0	23.0	38/40	48	12	1165.80.29.230	10
Pg 29	Pg 29	23.0	25.5	38/40	48	12	1165.80.29.255	10
Pg 36	Pg 36	25.0	30.5	50	54	15	1165.80.36.305	10
Pg 36	Pg 36	30.5	35.0	50	54	15	1165.80.36.350	10
Pg 48	Pg 48	39.0	43.0	65	59	15	1165.80.48.430	5
Pg 48	Pg 48	43.0	46.5	65	59	15	1165.80.48.465	5



Erhältlich mit Dichteinsatz gemäss EN 45545. Bei Anfragen oder Bestellung bitte ein F vor die Artikelnummer setzen.

Available with sealing inserts conformity with EN 45545. When placing an inquiry, prefix the article number by the capital F.

AGRO Kombi-EMV-Schlauchverschraubung für Kupfer-Hohlgeflechte

AGRO combination EMC conduit gland for copper braidings

Anschlussgewinde metrisch | Entry thread metric

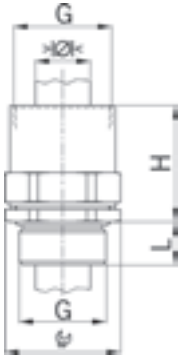

Material: Messing vernickelt
 O-Ring : NBR
 Einsatztemperatur: -40°C / +100°C
 Schutzart: IP 68 (mit Rohrflex®-Ringwellschlauch)

Material: Nickel-plated brass
 O-ring : NBR
 Temperature range: -40°C / +100°C
 Protection class: IP 68 (together with Rohrflex® corrugated tube)



Passend zu ROHRflex® Wellschlauch

Suitable for ROHRflex® corrugated tubings

G	> Ø < min mm	> Ø < max mm	IC	H mm	L mm	Art.-Nr. Art. No.	
M20x1.5	2.5	10.0	24	34.5	10	1165.84.20.15	25
M25x1.5	5.0	16.0	30	35.5	11	1165.84.25.21	25
M32x1.5	12.0	20.0	36	36.5	13	1165.84.32.34	25
M40x1.5	16.0	27.0	46	45	13	1165.84.40.34	10
M50x1.5	20.0	35.0	55	46	14	1165.84.50.42	5
M63x1.5	25.0	45.0	70	49	14	1165.84.63.54	5

Dank unserer Kombi-EMV-Schlauchverschraubung für Kupfer-Hohlgeflechte können die Geflechte problemlos auf Masse geführt werden. Eine Kontakthülse garantiert optimale und ausreissfeste Schirmkontaktierung und gleichzeitig eine vibrations sichere Einführung.

Copper braidings may be terminated without any problem with our combination EMC conduit gland. A contact bushing grants optimal shield contact and in the same moment vibration proof leading of cables.

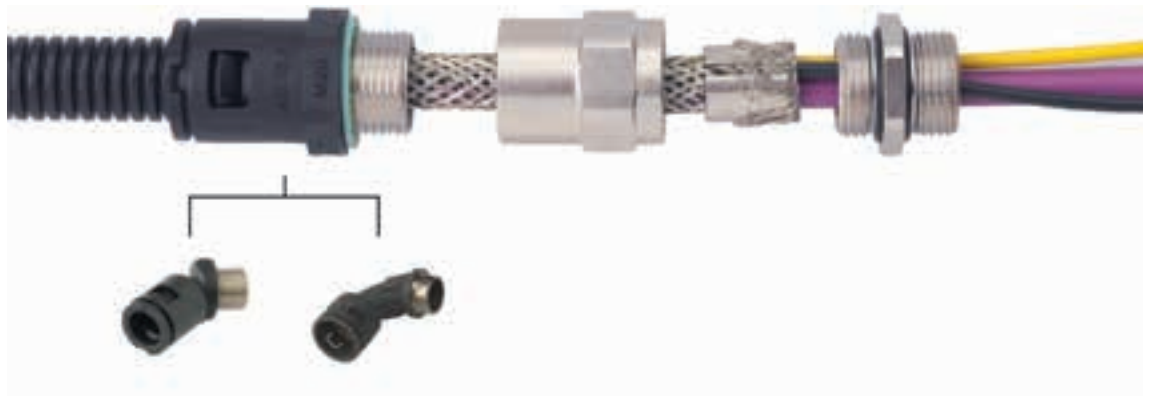

Druckring Messing zu Schlauchverschraubungen | Thrust collar brass for conduit glands

Druckring Messing zu Schlauchverschraubungen

Thrust collar brass for conduit glands

Material: Messing vernickelt
 Einsatzbereich: Zur Erdung sowie als Potenzialausgleich bei Verwendung von Schläuchen mit Metallgeflecht im EMV-Einsatz
 Einsatztemperatur: -40°C / +200°C

Material: Nickel-plated brass
 Application: For grounding as well as potential equalization by use of conduits with metal braiding for shielding applications
 Temperature range: -40°C / +200°C

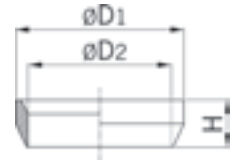

Zubehör zu Schlauchverschraubungen				Conduit glands accessories	
AD mm	ØD1 mm	ØD2 mm	H mm	Art.-Nr. Art. No.	
10	13	10.2	5.0	5031.034.007	50
14	17	14.5	5.0	5031.034.009	50
17	21	17.2	5.0	5031.034.011	50
19	23	19.2	6.0	5031.034.013	50
21	25	21.3	6.0	5031.034.016	50
27	32	27.3	8.5	5031.034.021	25
36	41	36.3	8.5	5031.034.029	25
45	50	45.3	8.5	5031.034.036	20
56	61	56.3	8.5	5031.034.048	10

Für EMV-Anwendungen Messingdruckring erforderlich! For EMC applications brass thrust collar necessary!



Dichtring Kunststoff zu Schlauchverschraubungen | Synthetic thrust collar for conduit glands

Dichtring Kunststoff zu Schlauchverschraubungen

Synthetic thrust collar for conduit glands

Material: PTFE (Teflon)
 Einsatzbereich: Bei Verwendung von Schutzschläuchen mit Verschraubungen, geeignet für hohe Temperaturen
 Einsatztemperatur: -60°C / +300°C

Material: PTFE (teflon)
 Application: By using tubes with conduit glands suitable for high temperatures
 Temperature range: -60°C / +300°C

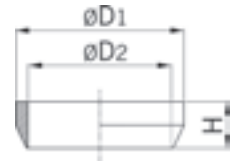

Zubehör zu Schlauchverschraubungen				Conduit glands accessories	
AD mm	ØD1 mm	ØD2 mm	H mm	Art.-Nr. Art. No.	
10	13	10.3	6.0	5030.013.010	50
14	17	14.3	6.0	5030.013.014	50
17	21	17.3	6.0	5030.013.017	50
19	23	19.3	7.0	5030.013.019	50
21	25	21.3	7.0	5030.013.021	50
27	32	27.4	9.5	5030.013.027	25
36	41	36.4	9.5	5030.013.036	25
45	50	45.4	9.5	5030.013.045	20
56	61	56.5	9.5	5030.013.056	10



Kabelverschraubung Progress® Kunststoff

Synthetic cable glands Progress®

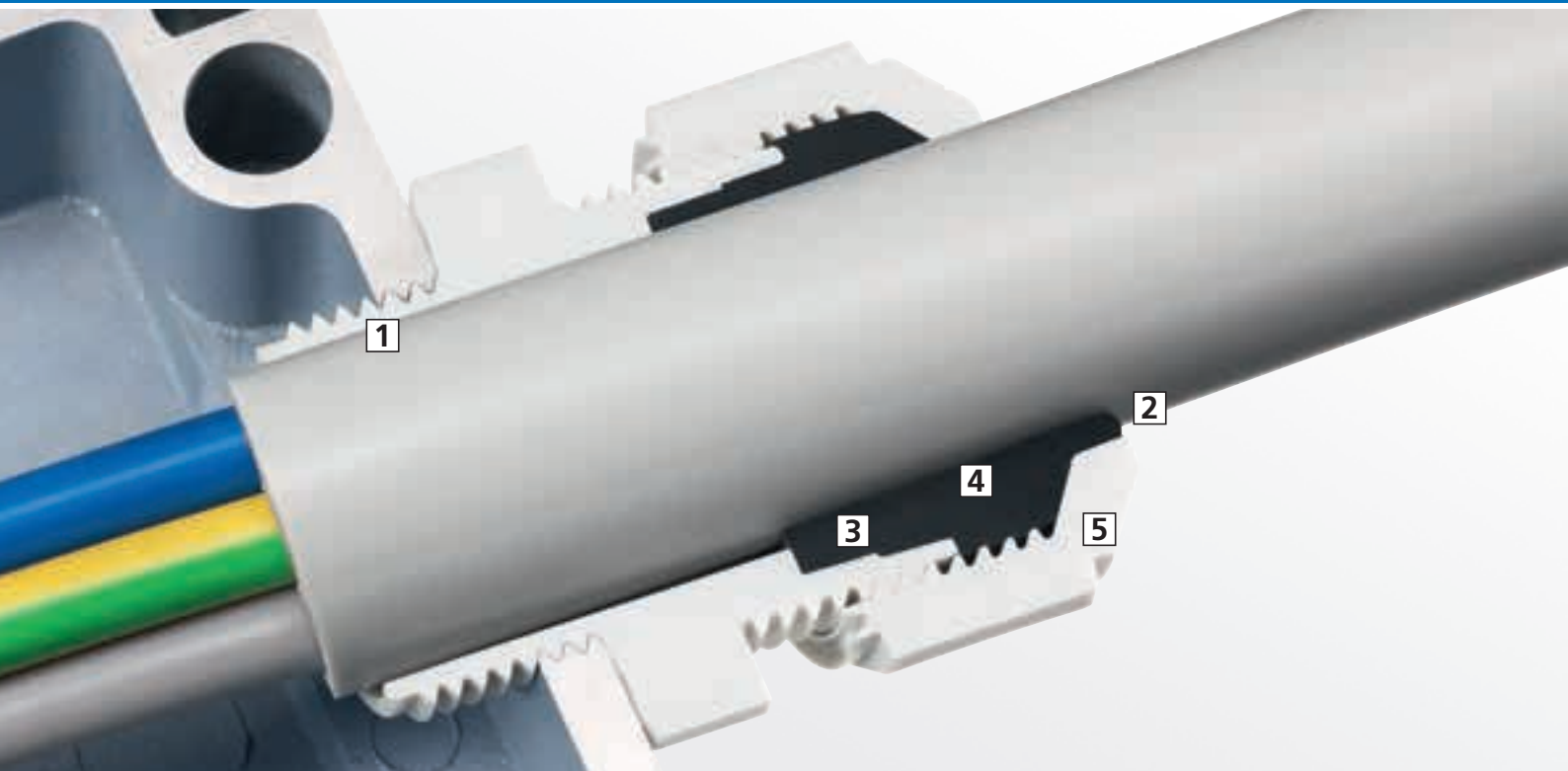

Kabelverschraubungen Progress® aus Kunststoff sind bewährte Helfer für die fachgerechte Kabeleinführung in Industrieanlagen.

Die herausragende Kompressionstechnik sorgt für eine hohe Dichtigkeit und eine äusserst kabelschonende Zugentlastung.

1 Kurzes oder langes Anschlussgewinde

Kompressionskabelverschraubungen mit kurzem oder langem Anschlussgewinde in metrischer oder Pg- Ausführung können bei vorhandenem Öffnungsgewinde oder mit Gegenmutter verwendet werden.

2 Sichtbare Sicherheit

Der kleine Wulst des Dichteinsatzes bestätigt das richtige Anzugsmoment.

3 Hoher Verdrehschutz

Der mit Halterippen ausgestattete Dichteinsatz sorgt für einen hohen Verdrehschutz.

4 Grosse Flexibilität

Zweiteilige Dichteinsätze können in Sekundenschnelle vor Ort auf den vorhandenen Kabeldurchmesser angepasst werden.

5 Garantierte Dichtigkeit

Auf den Dichteinsatz abgestimmte Innenkonturen sorgen für eine zielgerichtete Verformung des Dichteinsatzes und garantieren somit dessen perfekte Abdichtung.

Synthetic cable glands Progress® are tried and tested aids for correct cable entry in industrial equipment.

The outstanding compression technology for use everywhere guarantees an effective seal and excellent cable-protecting strain relief.

1 Short or long connection thread

Compression cable glands with short or long connection thread designed as metric or Pg can be used with existing opening threads or with a counter nut.

2 Visible safety

The small bead in the sealing insert confirms the correct tightening torque.

3 High distortion protection

The sealing insert fitted with retaining ribs guarantees high distortion protection.

4 Great flexibility

It only takes a few seconds to adapt the two-part sealing inserts on site to the existing cable diameters.

5 Guaranteed seal

The inner contours of the sealing inserts ensure that they are deformed in such a way as to make the perfect seal.

Dichteinsätze

Sealing inserts





einteiliger Dichteinsatz
One-piece sealing insert



zweiteiliger Dichteinsatz
Two-piece sealing insert



Kabelverschraubungen Progress® Kunststoff GFK Synthetic cable glands Progress® GFK	 <p>166 - 173</p>	1
Kabelverschraubungen Progress® Kunststoff GFK für mehrere Kabel Synthetic cable glands Progress® GFK for installation of multiple cables	 <p>174 - 175</p>	2



Ausführung / Version	Progress® Kunststoff Progress® Synthetic	Standard Standard	für mehrere Kabel for installation of multiple cables
Kompressionstechnik Compression technology		•	•
Gewinde / Thread			
Anschlussgewinde metrisch Entry thread metric		•	•
Anschlussgewinde Pg Entry thread Pg		•	•
Langes Anschlussgewinde Long entry thread		-	-
Dichteinsatz / Sealing insert			
für Rundkabel for round cables		•	•
für mehrere Kabel (Multi-Dichteinsatz) for multi sealing insert		•	•
einteiliger Dichteinsatz One-piece sealing insert		•	•
zweiteiliger Dichteinsatz Two-piece sealing insert		•	-
Technische Besonderheiten / Technical features			
Vibrationsschutz Vibration resistance		•	•
Farben / Colours			
Hellgrau RAL 7035 Light grey RAL 7035		•	•
Dunkelgrau RAL 7001 Dark grey RAL 7001		•	•
Schwarz RAL 9005 Black RAL 9005		•	•
Weiss RAL 9010 White RAL 9010		•	-
Graugrün RAL 7009 Greygreen RAL 7009		•	-

1
2
3
4
5
6
7
8
9
10
11
12

8

Kabelverschraubungen Progress® Kunststoff GFK

Synthetic cable glands Progress® GFK

Anschlussgewinde metrisch | Entry thread metric

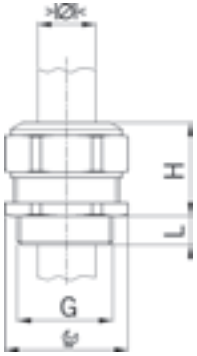

Material: Polyamid glasfaserverstärkt
 Eigenschaften: halogenfrei
 Dichtung: TPE
 Zugentlastung: Ausführung A
 Einsatztemperatur: -20°C / +100°C
 Schutzart: IP 68

Material: Polyamide glass fiber reinforced
 Properties: Halogen-free
 Seal: TPE
 Strain relief: Version A
 Temperature range: -20°C / +100°C
 Protection class: IP 68



Progress GFK

Hellgrau RAL 7035
 Einteiliger Dichteinsatz

Light grey RAL 7035
 One-piece sealing insert

G	> Ø < min mm	> Ø < max mm	PG	H mm	L mm	Art.-Nr. Art. No.	
M8x1.0	2.5	3.5	12	15.5	10	1571.08.035	50
M8x1.0	3.5	5.0	12	15.5	10	1571.08.050	50
M10x1.0	3.0	4.0	15	18.0	10	1571.10.040	50
M10x1.0	4.0	6.0	15	18.0	10	1571.10.060	50
M12x1.5	3.5	5.0	17	22.0	12	1571.12.050	50
M12x1.5	5.0	6.5	17	22.0	12	1571.12.065	50
M12x1.5	6.5	8.0	17	22.0	12	1571.12.080	50
M16x1.5	4.5	6.0	21	26.0	12	1571.17.060	50
M16x1.5	6.0	8.0	21	26.0	12	1571.17.080	50
M16x1.5	8.0	10.5	21	26.0	12	1571.17.105	50
M20x1.5	6.0	8.0	27	28.0	13	1571.20.080	50
M20x1.5	8.0	11.0	27	28.0	13	1571.20.110	50
M20x1.5	11.0	15.0	27	28.0	13	1571.20.150	50
M25x1.5	9.5	12.5	34	33.0	13	1571.25.125	25
M25x1.5	12.5	16.0	34	33.0	13	1571.25.160	25
M25x1.5	16.0	20.5	34	33.0	13	1571.25.205	25
M32x1.5	14.0	17.0	41	35.0	15	1571.32.170	25
M32x1.5	17.0	21.0	41	35.0	15	1571.32.210	25
M32x1.5	21.0	25.5	41	35.0	15	1571.32.255	25
M40x1.5	20.0	24.0	50	40.0	15	1571.40.240	10
M40x1.5	24.0	28.5	50	40.0	15	1571.40.285	10
M40x1.5	28.5	33.0	50	40.0	15	1571.40.330	10
M50x1.5	29.0	33.0	60	42.0	16	1571.50.330	10
M50x1.5	33.0	37.0	60	42.0	16	1571.50.370	10
M50x1.5	37.0	42.0	60	42.0	16	1571.50.420	10
M63x1.5	35.0	40.0	75	48.0	16	1571.63.400	5
M63x1.5	40.0	46.0	75	48.0	16	1571.63.460	5
M63x1.5	46.0	52.0	75	48.0	16	1571.63.520	5



Progress GFK

Hellgrau RAL 7035
 Zweiteiliger Dichteinsatz

Light grey RAL 7035
 Two-piece sealing insert

G	> Ø < min mm	> Ø < max mm	PG	H mm	L mm	Art.-Nr. Art. No.	
M16x1.5	6.0	10.5	21	26.0	12	1571.17	50
M20x1.5	8.0	15.0	27	28.0	13	1571.20	50
M25x1.5	12.5	20.5	34	33.0	13	1571.25	25
M32x1.5	17.0	25.5	41	35.0	15	1571.32	25
M40x1.5	24.0	33.0	50	40.0	15	1571.40	10
M50x1.5	33.0	42.0	60	42.0	16	1571.50	10
M63x1.5	40.0	52.0	75	48.0	16	1571.63	5



Kabelverschraubungen Progress® Kunststoff GFK

Synthetic cable glands Progress® GFK

Anschlussgewinde metrisch | Entry thread metric

Material: Agromid glasfaserverstärkt, wärmealterungs- und schlagzäh modifiziert
 Eigenschaften: halogenfrei
 Dichtung: TPE
 Zugentlastung: Ausführung A
 Einsatztemperatur: -30°C / +100°C
 Schutzart: IP 68

Material: Agromid glass fiber reinforced, heat aging and impact-resistant modified
 Properties: Halogen-free
 Seal: TPE
 Strain relief: Version A
 Temperature range: -30°C / +100°C
 Protection class: IP 68

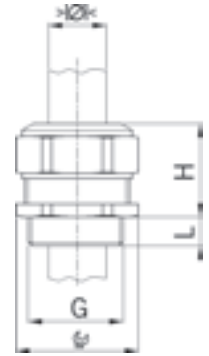

Progress GFK



Dunkelgrau RAL 7001 Einteiliger Dichteinsatz		Dark grey RAL 7001 One-piece sealing insert		Art.-Nr. Art. No.		
G	> Ø < min mm	> Ø < max mm	H mm	L mm		
M8x1.0	2.5	3.5	12	15.5	1572.08.035	50
M8x1.0	3.5	5.0	12	15.5	1572.08.050	50
M10x1.0	3.0	4.0	15	18.0	1572.10.040	50
M10x1.0	4.0	6.0	15	18.0	1572.10.060	50
M12x1.5	3.5	5.0	17	22.0	1572.12.050	50
M12x1.5	5.0	6.5	17	22.0	1572.12.065	50
M12x1.5	6.5	8.0	17	22.0	1572.12.080	50
M16x1.5	4.5	6.0	21	26.0	1572.17.060	50
M16x1.5	6.0	8.0	21	26.0	1572.17.080	50
M16x1.5	8.0	10.5	21	26.0	1572.17.105	50
M20x1.5	6.0	8.0	27	28.0	1572.20.080	50
M20x1.5	8.0	11.0	27	28.0	1572.20.110	50
M20x1.5	11.0	15.0	27	28.0	1572.20.150	50
M25x1.5	9.5	12.5	34	33.0	1572.25.125	25
M25x1.5	12.5	16.0	34	33.0	1572.25.160	25
M25x1.5	16.0	20.5	34	33.0	1572.25.205	25
M32x1.5	14.0	17.0	41	35.0	1572.32.170	25
M32x1.5	17.0	21.0	41	35.0	1572.32.210	25
M32x1.5	21.0	25.5	41	35.0	1572.32.255	25
M40x1.5	20.0	24.0	50	40.0	1572.40.240	10
M40x1.5	24.0	28.5	50	40.0	1572.40.285	10
M40x1.5	28.5	33.0	50	40.0	1572.40.330	10
M50x1.5	29.0	33.0	60	42.0	1572.50.330	10
M50x1.5	33.0	37.0	60	42.0	1572.50.370	10
M50x1.5	37.0	42.0	60	42.0	1572.50.420	10
M63x1.5	35.0	40.0	75	48.0	1572.63.400	5
M63x1.5	40.0	46.0	75	48.0	1572.63.460	5
M63x1.5	46.0	52.0	75	48.0	1572.63.520	5



Progress GFK



Dunkelgrau RAL 7001 Zweiteiliger Dichteinsatz		Dark grey RAL 7001 Two-piece sealing insert		Art.-Nr. Art. No.		
G	> Ø < min mm	> Ø < max mm	H mm	L mm		
M16x1.5	6.0	10.5	21	26.0	1572.17	50
M20x1.5	8.0	15.0	27	28.0	1572.20	50
M25x1.5	12.5	20.5	34	33.0	1572.25	25
M32x1.5	17.0	25.5	41	35.0	1572.32	25
M40x1.5	24.0	33.0	50	40.0	1572.40	10
M50x1.5	33.0	42.0	60	42.0	1572.50	10
M63x1.5	40.0	52.0	75	48.0	1572.63	5



Kabelverschraubungen Progress® Kunststoff GFK

Synthetic cable glands Progress® GFK

Anschlussgewinde metrisch | Entry thread metric

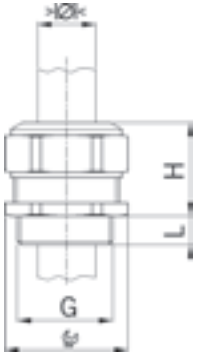

Material: Polyamid glasfaserverstärkt
 Eigenschaften: halogenfrei
 Dichtung: TPE
 Zugentlastung: Ausführung A
 Einsatztemperatur: -20°C / +100°C
 Schutzart: IP 68

Material: Polyamide glass fiber reinforced
 Properties: Halogen-free
 Seal: TPE
 Strain relief: Version A
 Temperature range: -20°C / +100°C
 Protection class: IP 68



Progress GFK

Schwarz RAL 9005
 Einteiliger Dichteinsatz

Black RAL 9005
 One-piece sealing insert

G	> Ø < min mm	> Ø < max mm	PG	H mm	L mm	Art.-Nr. Art. No.	
M8x1.0	2.5	3.5	12	15.5	10	1540.08.035	50
M8x1.0	3.5	5.0	12	15.5	10	1540.08.050	50
M10x1.0	3.0	4.0	15	18.0	10	1540.10.040	50
M10x1.0	4.0	6.0	15	18.0	10	1540.10.060	50
M12x1.5	3.5	5.0	17	22.0	12	1540.12.050	50
M12x1.5	5.0	6.5	17	22.0	12	1540.12.065	50
M12x1.5	6.5	8.0	17	22.0	12	1540.12.080	50
M16x1.5	4.5	6.0	21	26.0	12	1540.17.060	50
M16x1.5	6.0	8.0	21	26.0	12	1540.17.080	50
M16x1.5	8.0	10.5	21	26.0	12	1540.17.105	50
M20x1.5	6.0	8.0	27	28.0	13	1540.20.080	50
M20x1.5	8.0	11.0	27	28.0	13	1540.20.110	50
M20x1.5	11.0	15.0	27	28.0	13	1540.20.150	50
M25x1.5	9.5	12.5	34	33.0	13	1540.25.125	25
M25x1.5	12.5	16.0	34	33.0	13	1540.25.160	25
M25x1.5	16.0	20.5	34	33.0	13	1540.25.205	25
M32x1.5	14.0	17.0	41	35.0	15	1540.32.170	25
M32x1.5	17.0	21.0	41	35.0	15	1540.32.210	25
M32x1.5	21.0	25.5	41	35.0	15	1540.32.255	25
M40x1.5	20.0	24.0	50	40.0	15	1540.40.240	10
M40x1.5	24.0	28.5	50	40.0	15	1540.40.285	10
M40x1.5	28.5	33.0	50	40.0	15	1540.40.330	10
M50x1.5	29.0	33.0	60	42.0	16	1540.50.330	10
M50x1.5	33.0	37.0	60	42.0	16	1540.50.370	10
M50x1.5	37.0	42.0	60	42.0	16	1540.50.420	10
M63x1.5	35.0	40.0	75	48.0	16	1540.63.400	5
M63x1.5	40.0	46.0	75	48.0	16	1540.63.460	5
M63x1.5	46.0	52.0	75	48.0	16	1540.63.520	5



Progress GFK

Schwarz RAL 9005
 Zweiteiliger Dichteinsatz

Black RAL 9005
 Two-piece sealing insert

G	> Ø < min mm	> Ø < max mm	PG	H mm	L mm	Art.-Nr. Art. No.	
M16x1.5	6.0	10.5	21	26.0	12	1540.17	50
M20x1.5	8.0	15.0	27	28.0	13	1540.20	50
M25x1.5	12.5	20.5	34	33.0	13	1540.25	25
M32x1.5	17.0	25.5	41	35.0	15	1540.32	25
M40x1.5	24.0	33.0	50	40.0	15	1540.40	10
M50x1.5	33.0	42.0	60	42.0	16	1540.50	10
M63x1.5	40.0	52.0	75	48.0	16	1540.63	5



Kabelverschraubungen Progress® Kunststoff GFK

Synthetic cable glands Progress® GFK

Anschlussgewinde metrisch | Entry thread metric

Material: Polyamid glasfaserverstärkt
 Eigenschaften: halogenfrei
 Dichtung: TPE
 Zugentlastung: Ausführung A
 Einsatztemperatur: -20°C / +100°C
 Schutzart: IP 68

Material: Polyamide glass fiber reinforced
 Properties: Halogen-free
 Seal: TPE
 Strain relief: Version A
 Temperature range: -20°C / +100°C
 Protection class: IP 68

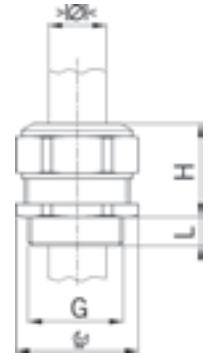

Progress GFK



Weiss RAL 9010 Einteiliger Dichteinsatz		White RAL 9010 One-piece sealing insert				Art.-Nr. Art. No.	
G	> Ø < min mm	> Ø < max mm	PG	H mm	L mm		
M20x1.5	6.0	8.0	27	28	13	1520.20.080	50
M20x1.5	8.0	11.0	27	28	13	1520.20.110	50



Progress GFK



Weiss RAL 9010 Zweiteiliger Dichteinsatz		White RAL 9010 Two-piece sealing insert				Art.-Nr. Art. No.	
G	> Ø < min mm	> Ø < max mm	PG	H mm	L mm		
M16x1.5	6.0	10.5	21	26	12	1520.17	50
M20x1.5	8.0	15.0	27	28	13	1520.20	50
M25x1.5	12.5	20.5	34	33	13	1520.25	25



Progress GFK



Graugrün RAL 7009 Zweiteiliger Dichteinsatz		Greygreen RAL 7009 Two-piece sealing insert				Art.-Nr. Art. No.	
G	> Ø < min mm	> Ø < max mm	PG	H mm	L mm		
M16x1.5	6.0	10.5	21	26	12	1570.17	50
M20x1.5	8.0	15.0	27	28	13	1570.20	50
M25x1.5	12.5	20.5	34	33	13	1570.25	25
M32x1.5	17.0	25.5	41	35	15	1570.32	25



1
2
3
4
5
6
7
8
9
10
11
12

8

Kabelverschraubungen Progress® Kunststoff GFK

Synthetic cable glands Progress® GFK

Anschlussgewinde Pg | Entry thread Pg

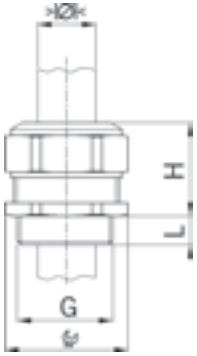

Material: Polyamid glasfaserverstärkt
 Eigenschaften: halogenfrei
 Dichtung: TPE
 Einsatztemperatur: -20°C / +100°C
 Schutzart: IP 68

Material: Polyamide glass fiber reinforced
 Properties: Halogen-free
 Seal: TPE
 Temperature range: -20°C / +100°C
 Protection class: IP 68



Progress GFK



Hellgrau RAL 7035
 Einteiliger Dichteinsatz

Light grey RAL 7035
 One-piece sealing insert

G	$\gt;\varnothing<$ min mm	$\gt;\varnothing<$ max mm		H mm	L mm	Art.-Nr. Art. No.	
Pg 7	3.5	5.0	17	22	12	1571.07.050	50
Pg 7	5.0	6.5	17	22	12	1571.07.065	50
Pg 7	6.5	8.0	17	22	12	1571.07.080	50
Pg 9	4.5	6.0	21	26	12	1571.09.060	50
Pg 9	6.0	8.0	21	26	12	1571.09.080	50
Pg 9	8.0	10.5	21	26	12	1571.09.105	50
Pg 11	4.0	5.5	24	28	12	1571.11.055	50
Pg 11	5.5	8.5	24	28	12	1571.11.085	50
Pg 11	8.5	12.0	24	28	12	1571.11.120	50
Pg 13	6.0	8.0	27	28	13	1571.13.080	50
Pg 13	8.0	11.0	27	28	13	1571.13.110	50
Pg 13	11.0	15.0	27	28	13	1571.13.150	50
Pg 16	6.0	8.0	27	28	13	1571.16.080	50
Pg 16	8.0	11.0	27	28	13	1571.16.110	50
Pg 16	11.0	15.0	27	28	13	1571.16.150	50
Pg 21	9.5	12.5	34	33	13	1571.21.125	25
Pg 21	12.5	16.0	34	33	13	1571.21.160	25
Pg 21	16.0	20.5	34	33	13	1571.21.205	25
Pg 29	16.0	19.0	41	36	13	1571.29.190	25
Pg 29	19.0	23.0	41	36	13	1571.29.230	25
Pg 29	23.0	27.5	41	36	13	1571.29.275	25
Pg 36	21.5	26.0	55	42	16	1571.36.260	10
Pg 36	26.0	30.5	55	42	16	1571.36.305	10
Pg 36	30.5	35.0	55	42	16	1571.36.350	10
Pg 42	29.0	33.0	60	42	16	1571.42.330	10
Pg 42	33.0	37.0	60	42	16	1571.42.370	10
Pg 42	37.0	42.0	60	42	16	1571.42.420	10
Pg 48	32.0	37.0	70	46	16	1571.48.370	5
Pg 48	37.0	43.0	70	46	16	1571.48.430	5
Pg 48	43.0	49.0	70	46	16	1571.48.490	5



Progress GFK



Hellgrau RAL 7035
 Zweiteiliger Dichteinsatz

Light grey RAL 7035
 Two-piece sealing insert

G	$\gt;\varnothing<$ min mm	$\gt;\varnothing<$ max mm		H mm	L mm	Art.-Nr. Art. No.	
Pg 9	6.0	10.5	21	26	12	1571.09	50
Pg 11	5.5	12.0	24	28	12	1571.11	50
Pg 13	8.0	15.0	27	28	13	1571.13	50
Pg 16	8.0	15.0	27	28	13	1571.16	50
Pg 21	12.5	20.5	34	33	13	1571.21	25
Pg 29	19.0	27.5	41	36	13	1571.29	25
Pg 36	26.0	35.0	55	42	16	1571.36	10
Pg 42	33.0	42.0	60	42	16	1571.42	10
Pg 48	37.0	49.0	70	46	16	1571.48	5

Kabelverschraubungen Progress® Kunststoff GFK

Synthetic cable glands Progress® GFK

Anschlussgewinde Pg | Entry thread Pg

Material: Agromid glasfaserverstärkt, wärmealterungs- und schlagzäh modifiziert
 Eigenschaften: halogenfrei
 Dichtung: TPE
 Einsatztemperatur: -30°C / +100°C
 Schutzart: IP 68

Material: Agromid glass fiber reinforced, heat aging and impact-resistant modified
 Properties: Halogen-free
 Seal: TPE
 Temperature range: -30°C / +100°C
 Protection class: IP 68

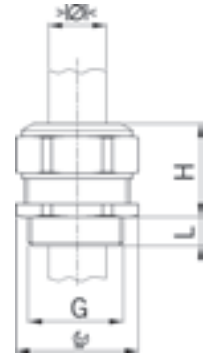

Progress GFK

Dunkelgrau RAL 7001 Einteiliger Dichteinsatz		Dark grey RAL 7001 One-piece sealing insert				Art.-Nr. Art. No.	
G	> Ø < min mm	> Ø < max mm		H mm	L mm		
Pg 7	3.5	5.0	17	22	12	1572.07.050	50
Pg 7	5.0	6.5	17	22	12	1572.07.065	50
Pg 7	6.5	8.0	17	22	12	1572.07.080	50
Pg 9	4.5	6.0	21	26	12	1572.09.060	50
Pg 9	6.0	8.0	21	26	12	1572.09.080	50
Pg 9	8.0	10.5	21	26	12	1572.09.105	50
Pg 11	4.0	5.5	24	28	12	1572.11.055	50
Pg 11	5.5	8.5	24	28	12	1572.11.085	50
Pg 11	8.5	12.0	24	28	12	1572.11.120	50
Pg 13	6.0	8.0	27	28	13	1572.13.080	50
Pg 13	8.0	11.0	27	28	13	1572.13.110	50
Pg 13	11.0	15.0	27	28	13	1572.13.150	50
Pg 16	6.0	8.0	27	28	13	1572.16.080	50
Pg 16	8.0	11.0	27	28	13	1572.16.110	50
Pg 16	11.0	15.0	27	28	13	1572.16.150	50
Pg 21	9.5	12.5	34	33	13	1572.21.125	25
Pg 21	12.5	16.0	34	33	13	1572.21.160	25
Pg 21	16.0	20.5	34	33	13	1572.21.205	25
Pg 29	16.0	19.0	41	36	13	1572.29.190	25
Pg 29	19.0	23.0	41	36	13	1572.29.230	25
Pg 29	23.0	27.5	41	36	13	1572.29.275	25
Pg 36	21.5	26.0	55	42	16	1572.36.260	10
Pg 36	26.0	30.5	55	42	16	1572.36.305	10
Pg 36	30.5	35.0	55	42	16	1572.36.350	10
Pg 42	29.0	33.0	60	42	16	1572.42.330	10
Pg 42	33.0	37.0	60	42	16	1572.42.370	10
Pg 42	37.0	42.0	60	42	16	1572.42.420	10
Pg 48	32.0	37.0	70	46	16	1572.48.370	5
Pg 48	37.0	43.0	70	46	16	1572.48.430	5
Pg 48	43.0	49.0	70	46	16	1572.48.490	5



Progress GFK

Dunkelgrau RAL 7001 Zweiteiliger Dichteinsatz		Dark grey RAL 7001 Two-piece sealing insert				Art.-Nr. Art. No.	
G	> Ø < min mm	> Ø < max mm		H mm	L mm		
Pg 9	6.0	10.5	21	26	12	1572.09	50
Pg 11	5.5	12.0	24	28	12	1572.11	50
Pg 13	8.0	15.0	27	28	13	1572.13	50
Pg 16	8.0	15.0	27	28	13	1572.16	50
Pg 21	12.5	20.5	34	33	13	1572.21	25
Pg 29	19.0	27.5	41	36	13	1572.29	25
Pg 36	26.0	35.0	55	42	16	1572.36	10
Pg 42	33.0	42.0	60	42	16	1572.42	10
Pg 48	37.0	49.0	70	46	16	1572.48	5



Kabelverschraubungen Progress® Kunststoff GFK

Synthetic cable glands Progress® GFK

Anschlussgewinde Pg | Entry thread Pg

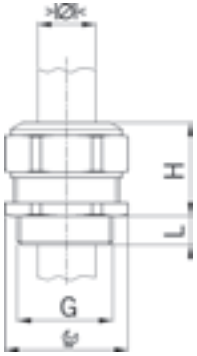

Material: Polyamid glasfaserverstärkt
 Eigenschaften: halogenfrei
 Dichtung: TPE
 Einsatztemperatur: -20°C / +100°C
 Schutzart: IP 68

Material: Polyamide glass fiber reinforced
 Properties: Halogen-free
 Seal: TPE
 Temperature range: -20°C / +100°C
 Protection class: IP 68



Progress GFK



Schwarz RAL 9005
 Einteiliger Dichteinsatz

Black RAL 9005
 One-piece sealing insert

G	$\gt;\varnothing<$ min mm	$\gt;\varnothing<$ max mm		H mm	L mm	Art.-Nr. Art. No.	
Pg 7	3.5	5.0	17	22	12	1540.07.050	50
Pg 7	5.0	6.5	17	22	12	1540.07.065	50
Pg 7	6.5	8.0	17	22	12	1540.07.080	50
Pg 9	4.5	6.0	21	26	12	1540.09.060	50
Pg 9	6.0	8.0	21	26	12	1540.09.080	50
Pg 9	8.0	10.5	21	26	12	1540.09.105	50
Pg 11	4.0	5.5	24	28	12	1540.11.055	50
Pg 11	5.5	8.5	24	28	12	1540.11.085	50
Pg 11	8.5	12.0	24	28	12	1540.11.120	50
Pg 13	6.0	8.0	27	28	13	1540.13.080	50
Pg 13	8.0	11.0	27	28	13	1540.13.110	50
Pg 13	11.0	15.0	27	28	13	1540.13.150	50
Pg 16	6.0	8.0	27	28	13	1540.16.080	50
Pg 16	8.0	11.0	27	28	13	1540.16.110	50
Pg 16	11.0	15.0	27	28	13	1540.16.150	50
Pg 21	9.5	12.5	34	33	13	1540.21.125	25
Pg 21	12.5	16.0	34	33	13	1540.21.160	25
Pg 21	16.0	20.5	34	33	13	1540.21.205	25
Pg 29	16.0	19.0	41	36	13	1540.29.190	25
Pg 29	19.0	23.0	41	36	13	1540.29.230	25
Pg 29	23.0	27.5	41	36	13	1540.29.275	25
Pg 36	21.5	26.0	55	42	16	1540.36.260	10
Pg 36	26.0	30.5	55	42	16	1540.36.305	10
Pg 36	30.5	35.0	55	42	16	1540.36.350	10
Pg 42	29.0	33.0	60	42	16	1540.42.330	10
Pg 42	33.0	37.0	60	42	16	1540.42.370	10
Pg 42	37.0	42.0	60	42	16	1540.42.420	10
Pg 48	32.0	37.0	70	46	16	1540.48.370	5
Pg 48	37.0	43.0	70	46	16	1540.48.430	5
Pg 48	43.0	49.0	70	46	16	1540.48.490	5



Progress GFK



Schwarz RAL 9005
 Zweiteiliger Dichteinsatz

Black RAL 9005
 Two-piece sealing insert

G	$\gt;\varnothing<$ min mm	$\gt;\varnothing<$ max mm		H mm	L mm	Art.-Nr. Art. No.	
Pg 9	6.0	10.5	21	26	12	1540.09	50
Pg 11	5.5	12.0	24	28	12	1540.11	50
Pg 13	8.0	15.0	27	28	13	1540.13	50
Pg 16	8.0	15.0	27	28	13	1540.16	50
Pg 21	12.5	20.5	34	33	13	1540.21	25
Pg 29	19.0	27.5	41	36	13	1540.29	25
Pg 36	26.0	35.0	55	42	16	1540.36	10
Pg 42	33.0	42.0	60	42	16	1540.42	10
Pg 48	37.0	49.0	70	46	16	1540.48	5

Kabelverschraubungen Progress® Kunststoff GFK

Synthetic cable glands Progress® GFK

Anschlussgewinde Pg | Entry thread Pg

Material: Polyamid glasfaserverstärkt
 Eigenschaften: halogenfrei
 Dichtung: TPE
 Einsatztemperatur: -20°C / +100°C
 Schutzart: IP 68

Material: Polyamide glass fiber reinforced
 Properties: Halogen-free
 Seal: TPE
 Temperature range: -20°C / +100°C
 Protection class: IP 68

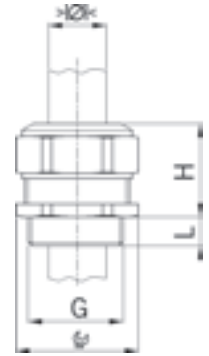

Progress GFK



Weiss RAL 9010 Einteiliger Dichteinsatz		White RAL 9010 One-piece sealing insert				Art.-Nr. Art. No.	
G	>Ø< min mm	>Ø< max mm	IC	H mm	L mm		
Pg 16	6.0	8.0	27	28	13	1520.16.080	50
Pg 16	8.0	11.0	27	28	13	1520.16.110	50



Progress GFK



Weiss RAL 9010 Zweiteiliger Dichteinsatz		White RAL 9010 Two-piece sealing insert				Art.-Nr. Art. No.	
G	>Ø< min mm	>Ø< max mm	IC	H mm	L mm		
Pg 11	5.5	12.0	24	28	12	1520.11	50
Pg 16	8.0	15.0	27	28	13	1520.16	50



Progress GFK



Graugrün RAL 7009 Zweiteiliger Dichteinsatz		Greygreen RAL 7009 Two-piece sealing insert				Art.-Nr. Art. No.	
G	>Ø< min mm	>Ø< max mm	IC	H mm	L mm		
Pg 9	6.0	10.5	21	26	12	1570.09	50
Pg 11	5.5	12.0	24	28	12	1570.11	50
Pg 13	8.0	15.0	27	28	13	1570.13	50
Pg 16	8.0	15.0	27	28	13	1570.16	50
Pg 21	12.5	20.5	34	33	13	1570.21	25
Pg 29	19.0	27.5	41	36	13	1570.29	25



Kabelverschraubungen Progress® Kunststoff GFK für mehrere Kabel Synthetic cable glands Progress® GFK for installation of multiple cables

Anschlussgewinde metrisch | Entry thread metric

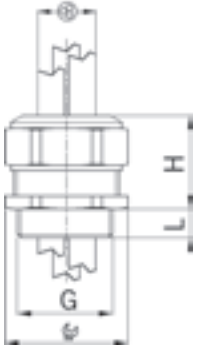

Material: Polyamid glasfaserverstärkt
Eigenschaften: halogenfrei
Dichtung: TPE
Zugentlastung: Ausführung A
Einsatztemperatur: -20°C / +100°C
Schutzart: IP 68

Material: Polyamide glass fiber reinforced
Properties: Halogen-free
Seal: TPE
Strain relief: Version A
Temperature range: -20°C / +100°C
Protection class: IP 68



Progress GFK Multi



Hellgrau RAL 7035
Einteiliger Dichteinsatz

Light grey RAL 7035
One-piece sealing insert

G	> Ø < min mm	> Ø < max mm	⊗	IP	H mm	L mm	Art.-Nr. Art. No.	📦
M16x1.5	2.0	3.0	2	21	26	12	1571.17.2.030	50
M16x1.5	2.5	4.0	2	21	26	12	1571.17.2.040	50
M16x1.5	3.5	5.0	2	21	26	12	1571.17.2.050	50
M20x1.5	3.5	5.0	2	27	28	13	1571.20.2.050	50
M20x1.5	4.5	6.0	2	27	28	13	1571.20.2.060	50
M20x1.5	5.5	7.5	2	27	28	13	1571.20.2.075	50
M20x1.5	3.5	5.0	3	27	28	13	1571.20.3.050	50
M20x1.5	4.5	6.0	3	27	28	13	1571.20.3.060	50
M20x1.5	5.2	6.5	3	27	28	13	1571.20.3.065	50
M20x1.5	3.5	5.0	4	27	28	13	1571.20.4.050	50
M20x1.5	4.5	6.0	4	27	28	13	1571.20.4.060	50
M25x1.5	5.0	7.0	2	34	33	13	1571.25.2.070	25
M25x1.5	6.7	9.0	2	34	33	13	1571.25.2.090	25
M25x1.5	7.7	10.0	2	34	33	13	1571.25.2.100	25
M25x1.5	5.5	7.0	3	34	33	13	1571.25.3.070	25
M25x1.5	6.8	9.0	3	34	33	13	1571.25.3.090	25
M25x1.5	5.5	7.0	4	34	33	13	1571.25.4.070	25
M25x1.5	4.8	6.0	6	34	33	13	1571.25.6.060	25
M32x1.5	9.0	11.5	2	41	35	15	1571.32.2.115	25
M32x1.5	7.0	9.0	3	41	35	15	1571.32.3.090	25
M32x1.5	8.5	10.5	3	41	35	15	1571.32.3.105	25
M32x1.5	7.0	9.0	4	41	35	15	1571.32.4.090	25
M32x1.5	5.8	7.0	6	41	35	15	1571.32.6.070	25

Weitere Ausführungen und Farben auf Anfrage: z.B. dunkelgrau RAL 7001, schwarz RAL 9005, grössere Anschlussgewinde

Additional versions and colours are available upon request: e.g. dark grey RAL 7001, black RAL 9005, larger entry threads

Kabelverschraubungen Progress® Kunststoff GFK für mehrere Kabel Synthetic cable glands Progress® GFK for installation of multiple cables

Anschlussgewinde Pg | Entry thread Pg

Material: Polyamid glasfaserverstärkt
Eigenschaften: halogenfrei
Dichtung: TPE
Einsatztemperatur: -20°C / +100°C
Schutzart: IP 68

Material: Polyamide glass fiber reinforced
Properties: Halogen-free
Seal: TPE
Temperature range: -20°C / +100°C
Protection class: IP 68

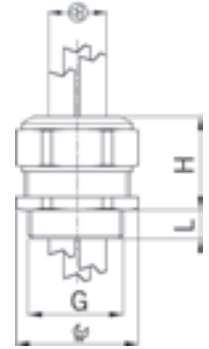

Progress GFK Multi



Hellgrau RAL 7035 Einteiliger Dichteinsatz		Light grey RAL 7035 One-piece sealing insert				Art.-Nr. Art. No.		
G	>Ø< min mm	>Ø< max mm			H mm	L mm		
Pg 9	2.0	3.0	2	21	26	12	1571.09.2.030	50
Pg 9	2.5	4.0	2	21	26	12	1571.09.2.040	50
Pg 9	3.5	5.0	2	21	26	12	1571.09.2.050	50
Pg 11	3.5	5.0	2	24	28	12	1571.11.2.050	50
Pg 11	4.5	6.0	2	24	28	12	1571.11.2.060	50
Pg 11	3.5	5.0	3	24	28	12	1571.11.3.050	50
Pg 13	3.5	5.0	2	27	28	13	1571.13.2.050	50
Pg 13	4.5	6.0	2	27	28	13	1571.13.2.060	50
Pg 13	5.5	7.5	2	27	28	13	1571.13.2.075	50
Pg 13	3.5	5.0	3	27	28	13	1571.13.3.050	50
Pg 13	4.5	6.0	3	27	28	13	1571.13.3.060	50
Pg 13	5.2	6.5	3	27	28	13	1571.13.3.065	50
Pg 13	3.5	5.0	4	27	28	13	1571.13.4.050	50
Pg 13	4.5	6.0	4	27	28	13	1571.13.4.060	50
Pg 16	3.5	5.0	2	27	28	13	1571.16.2.050	50
Pg 16	4.5	6.0	2	27	28	13	1571.16.2.060	50
Pg 16	5.5	7.5	2	27	28	13	1571.16.2.075	50
Pg 16	3.5	5.0	3	27	28	13	1571.16.3.050	50
Pg 16	4.5	6.0	3	27	28	13	1571.16.3.060	50
Pg 16	5.2	6.5	3	27	28	13	1571.16.3.065	50
Pg 16	3.5	5.0	4	27	28	13	1571.16.4.050	50
Pg 16	4.5	6.0	4	27	28	13	1571.16.4.060	50
Pg 21	5.0	7.0	2	34	33	13	1571.21.2.070	25
Pg 21	6.7	9.0	2	34	33	13	1571.21.2.090	25
Pg 21	7.7	10.0	2	34	33	13	1571.21.2.100	25
Pg 21	5.5	7.0	3	34	33	13	1571.21.3.070	25
Pg 21	6.8	9.0	3	34	33	13	1571.21.3.090	25
Pg 21	5.5	7.0	4	34	33	13	1571.21.4.070	25
Pg 21	4.8	6.0	6	34	33	13	1571.21.6.060	25
Pg 29	7.5	9.0	3	41	36	13	1571.29.3.090	25

Weitere Ausführungen und Farben auf Anfrage: z.B. dunkelgrau RAL 7001, schwarz RAL 9005, grössere Anschlussgewinde
Additional versions and colours are available upon request: e.g. dark grey RAL 7001, black RAL 9005, larger entry threads



Kabelverschraubungen Syntec® Messing und Kunststoff

Cable glands Syntec® nickel-plated brass and synthetic

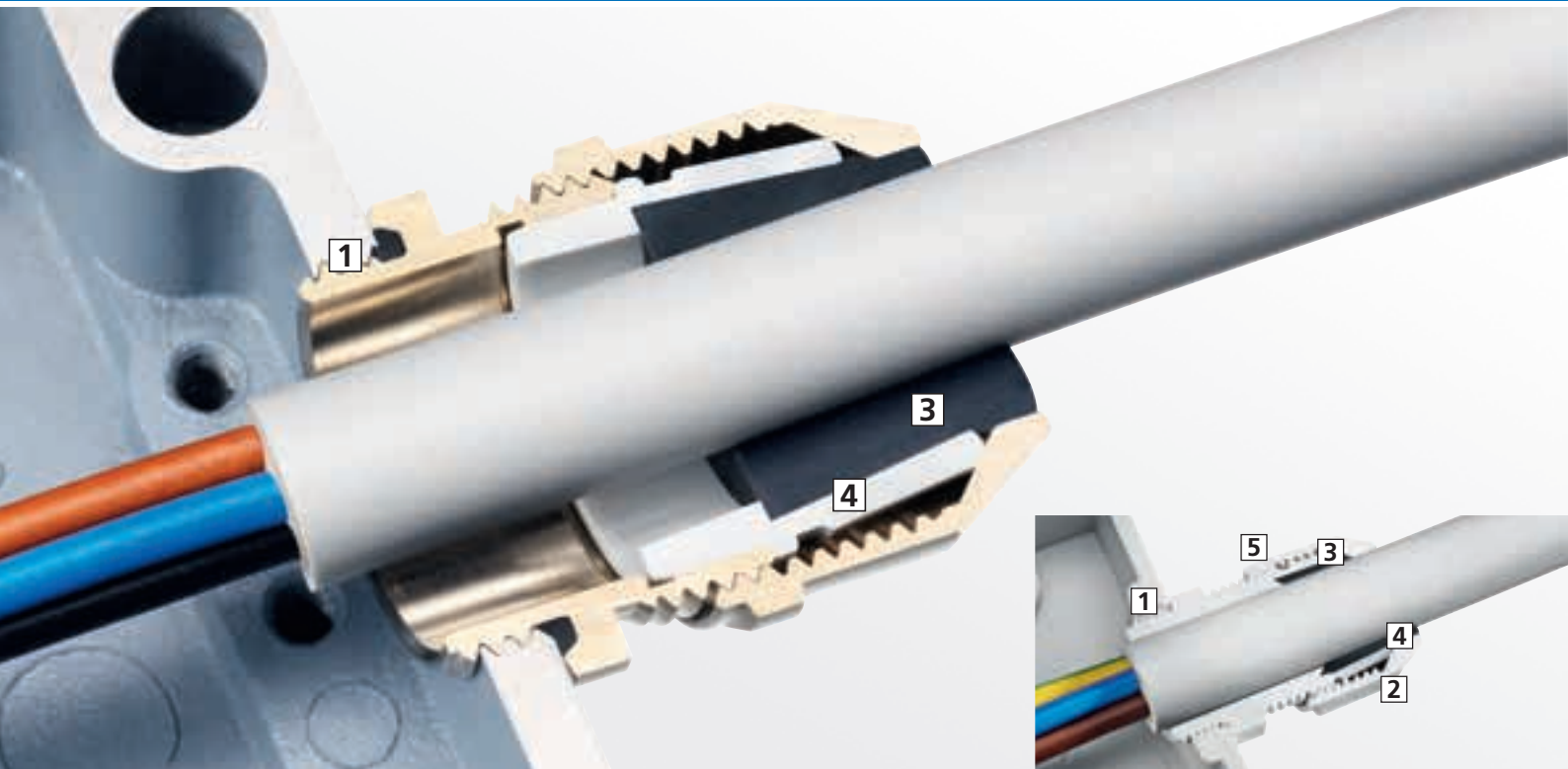

Kabelverschraubungen Syntec® Messing und Kunststoff mit innovativer Lamellentechnik. Die beweglichen Gelenklamellen ermöglichen grosse Klemm- und Dichtbereiche für den flexiblen und sicheren täglichen Einsatz. Die Vorfixierung der Kunststoff Druckmutter erleichtert Überkopf-Montagen sehr.

1 Kurzes oder langes Gewinde

Qualitätsverschraubungen mit kurzem oder langem metrischen Gewinde für die sichere Befestigung mit Gewinde oder Gegenmutter.

2 Hörbare Sicherheit in Kunststoff

Die Rastnocken der Druckmutter garantieren mit hörbarem „Klick“ immer den vibrations- und rüttelfesten Halt des Kabels.

3 Garantierte Dichtigkeit

Die elastischen, umweltbeständigen Dichtringe halten sicher dicht, sind besonders langlebig und garantieren die Schutzart IP 68.

4 Patentierte Lamellentechnik

Die von AGRO entwickelte Lamellengeometrie mit beweglichen Gelenklamellen ermöglicht das Einführen verschiedener Durchmesser in die Syntec® Kabelverschraubung bei hervorragender Zugentlastung und exzellentem Verdrehschutz.

5 Grosse Schlüsselflächen in Kunststoff

Der grossflächige Sechskant der Druckmutter bietet immer sicheren und festen Halt beim Andrehen von Hand und Festziehen mit dem Werkzeug.

AGRO Cable glands Syntec® nickel-plated brass and synthetic material with innovative lamellar technology. The movable articulated lamellas provide large clamping and sealing areas for secure and flexible everyday use. The pre-fixation of the synthetic compression nut allows for overhead installation.

1 Short or long thread

Quality cable glands with a short or long metrical thread for secure fastening with thread or counter nut.

2 Audible reliability in synthetic material

The snap-in pins of the compression nuts give an audible „click“ that guarantees vibration- and shake-proof hold.

3 Guaranteed tightness

The elastic sealing rings with good chemical resistance provide a reliable seal, are particularly durable and offer guaranteed protection to protection class IP 68.

4 Patented lamellar technology

The AGRO-developed lamellar geometry with movable jointed lamellar support the insertion of varying diameters into the Syntec® cable gland and ensure outstanding strain relief and distortion protection.

5 Large spanner flats in synthetic material

The large hexagonal element of the screw-down nuts ensures consistently reliable and secure hold when turning by hand and tightening with the tool.

Trapezförmige Gelenklamellen

Trapezoidal lamellas



Die patentierte, einzigartige Lamellentechnik garantiert eine hervorragende Zugentlastung.

The patented, unique lamellar technology guarantees an excellent strain relief.





Die trapezförmigen Lamellen gleiten beim Anziehen der Kabelverschraubung ineinander und verpressen das Kabel verdrehsicher in ein Sechseck.

When tightening the compression nut of the cable gland, the single lamellas slide into a hexagon and thus compress the cable in a torsion proof way.





Kabelverschraubungen Syntec® Messing mit Lamellentechnik Cable glands Syntec® nickel-plated brass with lamellar technology	 178 - 179
Kabelverschraubungen Syntec® Kunststoff mit Lamellentechnik Synthetic cable glands Syntec® with lamellar technology	 180 - 185
Kabelverschraubungen Syntec® Kunststoff mit Lamellentechnik und Knickschutz Synthetic Syntec® cable glands with lamellar technology and antikink nozzle	 186 - 189

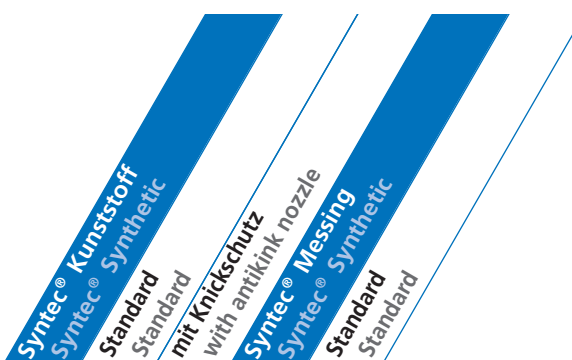

Ausführung / Version	Syntec® Kunststoff Standard	mit Knickschutz with antikink nozzle	Syntec® Messing Standard
Lamellentechnik Lamellar technology	•	•	•
Gewinde / Thread			
Anschlussgewinde Pg Entry thread Pg	•	•	•
Anschlussgewinde NPT Entry thread NPT	•	•	-
Kurzes Anschlussgewinde metrisch Short entry thread metric	•	•	•
Langes Anschlussgewinde metrisch Long entry thread metric	•	•	•
Dichteinsatz / Sealing insert			
für Rundkabel for round cables	•	•	•
Standard Dichtring (TPE/CR) Standard sealing ring (TPE/CR)	•	•	•
Technische Besonderheiten / Technical features			
erhöhter Vibrationsschutz Increased Vibration resistance	•	•	-
Knickschutz Antikink coil	-	•	-
Farben / Colours			
Hellgrau RAL 7035 Light grey RL 7035	•	•	-
Dunkelgrau RAL 7001 Dark grey RAL 7001	•	•	-
Schwarz RAL 9005 Black RAL 9005	•	•	-
Messing vernickelt Nickel-plated brass	-	-	•

1
2
3
4
5
6
7
8
9
10
11
12

Kabelverschraubungen Syntec® Messing mit Lamellentechnik

Cable glands Syntec® nickel-plated brass with lamellar technology

Kurzes Anschlussgewinde metrisch | Short entry thread metric

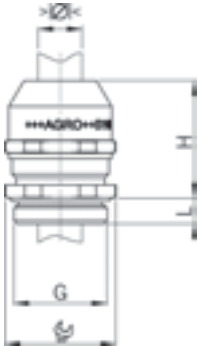

Material: Messing vernickelt
 Dichtring: TPE
 O-Ring: NBR
 Lamelleneinsatz: Polyamid PA 6
 Einsatztemperatur: -40°C / +100°C
 Schutzart: IP 68

Material: Nickel-plated brass
 Sealing ring: TPE
 O-ring: NBR
 Lamellar insert: Polyamide PA 6
 Temperature range: -40°C / +100°C
 Protection class: IP 68



SYNTEC MS



Einteiliger Dichtring
 nicht durchgehend isolierend

One-piece sealing ring
 not overall length insulated

G	> Ø < min mm	> Ø < max mm		H mm	L mm	Art.-Nr. Art. No.	
M12x1.5	1.0	5.0	15	17	5	1045.12.050	50
M12x1.5	3.0	7.0	15	17	5	1045.12.070	50
M16x1.5	2.0	6.0	18	20	5	1045.17.060	50
M16x1.5	4.5	10.0	18	20	5	1045.17.100	50
M20x1.5	3.5	8.0	22	25	6	1045.20.080	50
M20x1.5	7.0	13.0	22	25	6	1045.20.130	50
M25x1.5	5.0	11.0	28	31	7	1045.25.110	25
M25x1.5	10.0	17.0	28	31	7	1045.25.170	25
M32x1.5	7.0	15.0	36	33	8	1045.32.150	25
M32x1.5	13.0	21.0	36	33	8	1045.32.210	25
M40x1.5	15.0	23.0	46	40	8	1045.40.230	10
M40x1.5	19.0	28.0	46	40	8	1045.40.280	10
M50x1.5	20.0	29.0	55	40	9	1045.50.290	5
M50x1.5	25.0	35.0	55	40	9	1045.50.350	5
M63x1.5	28.0	39.0	70	43	10	1045.63.390	5
M63x1.5	35.0	48.0	70	43	10	1045.63.480	5

Langes Anschlussgewinde metrisch | Long entry thread metric



SYNTEC MS



Einteiliger Dichtring
 nicht durchgehend isolierend

One-piece sealing ring
 not overall length insulated

G	> Ø < min mm	> Ø < max mm		H mm	L mm	Art.-Nr. Art. No.	
M12x1.5	1.0	5.0	15	17	12	1145.12.050	50
M12x1.5	3.0	7.0	15	17	12	1145.12.070	50
M16x1.5	2.0	6.0	18	20	12	1145.17.060	50
M16x1.5	4.5	10.0	18	20	12	1145.17.100	50
M20x1.5	3.5	8.0	22	25	12	1145.20.080	50
M20x1.5	7.0	13.0	22	25	12	1145.20.130	50
M25x1.5	5.0	11.0	28	31	12	1145.25.110	25
M25x1.5	10.0	17.0	28	31	12	1145.25.170	25
M32x1.5	7.0	15.0	36	33	15	1145.32.150	25
M32x1.5	13.0	21.0	36	33	15	1145.32.210	25
M40x1.5	15.0	23.0	46	40	15	1145.40.230	10
M40x1.5	19.0	28.0	46	40	15	1145.40.280	10
M50x1.5	20.0	29.0	55	40	15	1145.50.290	5
M50x1.5	25.0	35.0	55	40	15	1145.50.350	5
M63x1.5	28.0	39.0	70	43	15	1145.63.390	5
M63x1.5	35.0	48.0	70	43	15	1145.63.480	5
M63x1.5	44.0	55.0	80	43	15	1145.63.550	5

Kabelverschraubungen Syntec® Messing mit Lamellentechnik

Cable glands Syntec® nickel-plated brass with lamellar technology

Kurzes Anschlussgewinde Pg | Short entry thread Pg

Material: Messing vernickelt
 Dichtring: TPE
 O-Ring : NBR
 Lamelleneinsatz: Polyamid PA 6
 Einsatztemperatur: -40°C / +100°C
 Schutzart: IP 68

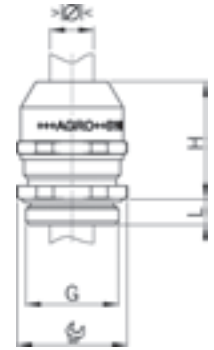

Material: Nickel-plated brass
 Sealing ring: TPE
 O-ring : NBR
 Lamellar insert: Polyamide PA 6
 Temperature range: -40°C / +100°C
 Protection class: IP 68



SYNTEC MS

Einteiliger Dichtring
 nicht durchgehend isolierend

One-piece sealing ring
 not overall length insulated

G	> Ø < min mm	> Ø < max mm		H mm	L mm	Art.-Nr. Art. No.	
Pg 7	1.0	5.0	15	17	5	1045.07.050	50
Pg 7	3.0	7.0	15	17	5	1045.07.070	50
Pg 9	2.0	6.0	18	20	6	1045.09.060	50
Pg 9	4.5	10.0	18	20	6	1045.09.100	50
Pg 11	3.5	8.0	22	25	6	1045.11.080	50
Pg 11	7.0	13.0	22	25	6	1045.11.130	50
Pg 13	3.5	8.0	22	25	6.5	1045.13.080	50
Pg 13	7.0	13.0	22	25	6.5	1045.13.130	50
Pg 16	3.5	8.0	24	25	6.5	1045.16.080	50
Pg 16	5.0	11.0	24	25	6.5	1045.16.110	25
Pg 16	7.0	13.0	28	31	6.5	1045.16.130	50
Pg 16	10.0	17.0	28	31	6.5	1045.16.170	25
Pg 21	7.0	15.0	36	33	7	1045.21.150	25
Pg 21	13.0	21.0	36	33	7	1045.21.210	25
Pg 29	15.0	23.0	46	40	8	1045.29.230	10
Pg 29	19.0	28.0	46	40	8	1045.29.280	10
Pg 36	20.0	29.0	55	40	9	1045.36.290	5
Pg 36	25.0	35.0	55	40	9	1045.36.350	5
Pg 42	20.0	29.0	55	40	10	1045.42.290	5
Pg 42	25.0	35.0	55	40	10	1045.42.350	5
Pg 48	28.0	39.0	70	43	10	1045.48.390	5
Pg 48	35.0	48.0	70	43	10	1045.48.480	5



Kabelverschraubungen Syntec® Kunststoff mit Lamellentechnik

Synthetic cable glands Syntec® with lamellar technology

Kurzes Anschlussgewinde metrisch | Short entry thread metric

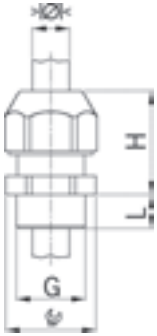

Material: Polyamid PA 6
 Eigenschaften: halogenfrei
 Dichtring: TPE oder CR (Neopren)
 Einsatztemperatur: -30°C / +100°C
 Schutzart: IP 68

Material: Polyamide PA 6
 Properties: Halogen-free
 Sealing ring: TPE or CR (Neoprene)
 Temperature range: -30°C / +100°C
 Protection class: IP 68



SYNTEC

Hellgrau RAL 7035
 Einteiliger Dichtring

Light grey RAL 7035
 One-piece sealing ring

G	>Ø< min mm	>Ø< max mm	IP	H mm	L mm	Art.-Nr. Art. No.	
M12x1.5	2.5	6.5	15	21	6	1555.12.06	100
M16x1.5	2.0	6.0	19	25	8	1555.17.06	50
M16x1.5	4.5	10.0	19	25	8	1555.17.10	50
M20x1.5	3.5	8.0	24	29	9	1555.20.08	50
M20x1.5	7.0	13.0	24	29	9	1555.20.13	50
M25x1.5	5.0	11.0	29	38	10	1555.25.11	25
M25x1.5	10.0	17.0	29	38	10	1555.25.17	25
M32x1.5	17.0	25.0	42	36	10	1555.32.25	20



SYNTEC

Dunkelgrau RAL 7001
 Einteiliger Dichtring

Dark grey RAL 7001
 One-piece sealing ring

G	>Ø< min mm	>Ø< max mm	IP	H mm	L mm	Art.-Nr. Art. No.	
M12x1.5	2.5	6.5	15	21	6	1556.12.06	100
M16x1.5	2.0	6.0	19	25	8	1556.17.06	50
M16x1.5	4.5	10.0	19	25	8	1556.17.10	50
M20x1.5	3.5	8.0	24	29	9	1556.20.08	50
M20x1.5	7.0	13.0	24	29	9	1556.20.13	50
M25x1.5	5.0	11.0	29	38	10	1556.25.11	25
M25x1.5	10.0	17.0	29	38	10	1556.25.17	25
M32x1.5	17.0	25.0	42	36	10	1556.32.25	20



SYNTEC

Schwarz RAL 9005
 Einteiliger Dichtring

Black RAL 9005
 One-piece sealing ring

G	>Ø< min mm	>Ø< max mm	IP	H mm	L mm	Art.-Nr. Art. No.	
M12x1.5	2.5	6.5	15	21	6	1545.12.06	100
M16x1.5	2.0	6.0	19	25	8	1545.17.06	50
M16x1.5	4.5	10.0	19	25	8	1545.17.10	50
M20x1.5	3.5	8.0	24	29	9	1545.20.08	50
M20x1.5	7.0	13.0	24	29	9	1545.20.13	50
M25x1.5	5.0	11.0	29	38	10	1545.25.11	25
M25x1.5	10.0	17.0	29	38	10	1545.25.17	25
M32x1.5	17.0	25.0	42	36	10	1545.32.25	20

Kabelverschraubungen Syntec® Kunststoff mit Lamellentechnik Synthetic cable glands Syntec® with lamellar technology

Langes Anschlussgewinde metrisch | Long entry thread metric

Material: Polyamid PA 6
Eigenschaften: halogenfrei
Dichtring: TPE oder CR (Neopren)
Einsatztemperatur: -30°C / +100°C
Schutzart: IP 68

Material: Polyamide PA 6
Properties: Halogen-free
Sealing ring: TPE or CR (Neoprene)
Temperature range: -30°C / +100°C
Protection class: IP 68

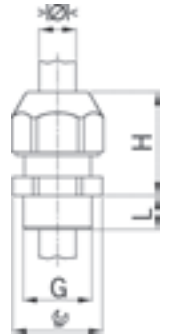

SYNTEC



Hellgrau RAL 7035 Einteiliger Dichtring		Light grey RAL 7035 One-piece sealing ring				Art.-Nr. Art. No.	
G	$\frac{> \phi <}{\text{min mm}}$	$\frac{> \phi <}{\text{max mm}}$		H mm	L mm		
M12x1.5	2.5	6.5	15	21	12	1555.12.1.06	100
M16x1.5	2.0	6.0	19	25	15	1555.17.1.06	50
M16x1.5	4.5	10.0	19	25	15	1555.17.1.10	50
M20x1.5	3.5	8.0	24	29	15	1555.20.1.08	50
M20x1.5	7.0	13.0	24	29	15	1555.20.1.13	50
M25x1.5	5.0	11.0	29	38	15	1555.25.1.11	25
M25x1.5	10.0	17.0	29	38	15	1555.25.1.17	25
M32x1.5	17.0	25.0	42	36	15	1555.32.1.25	20
M40x1.5	22.0	33.0	53	48	15	1555.40.1.33	10
M50x1.5	28.0	38.0	60	48	15	1555.50.1.38	5
M63x1.5	32.0	44.0	65	49	16	1555.63.1.44	5



SYNTEC



Dunkelgrau RAL 7001 Einteiliger Dichtring		Dark grey RAL 7001 One-piece sealing ring				Art.-Nr. Art. No.	
G	$\frac{> \phi <}{\text{min mm}}$	$\frac{> \phi <}{\text{max mm}}$		H mm	L mm		
M12x1.5	2.5	6.5	15	21	12	1556.12.1.06	100
M16x1.5	2.0	6.0	19	25	15	1556.17.1.06	50
M16x1.5	4.5	10.0	19	25	15	1556.17.1.10	50
M20x1.5	3.5	8.0	24	29	15	1556.20.1.08	50
M20x1.5	7.0	13.0	24	29	15	1556.20.1.13	50
M25x1.5	5.0	11.0	29	38	15	1556.25.1.11	25
M25x1.5	10.0	17.0	29	38	15	1556.25.1.17	25
M32x1.5	17.0	25.0	42	36	15	1556.32.1.25	20
M40x1.5	22.0	33.0	53	48	15	1556.40.1.33	10
M50x1.5	28.0	38.0	60	48	15	1556.50.1.38	5
M63x1.5	32.0	44.0	65	49	16	1556.63.1.44	5



Kabelverschraubungen Syntec® Kunststoff mit Lamellentechnik

Synthetic cable glands Syntec® with lamellar technology

Langes Anschlussgewinde metrisch | Long entry thread metric

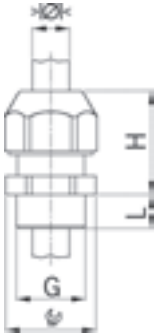

Material: Polyamid PA 6
 Eigenschaften: halogenfrei
 Dichtring: TPE oder CR (Neopren)
 Einsatztemperatur: -30°C / +100°C
 Schutzart: IP 68

Material: Polyamide PA 6
 Properties: Halogen-free
 Sealing ring: TPE or CR (Neoprene)
 Temperature range: -30°C / +100°C
 Protection class: IP 68



SYNTEC

Schwarz RAL 9005
 Einteiliger Dichtring

Black RAL 9005
 One-piece sealing ring



G	> Ø < min mm	> Ø < max mm	IP	H mm	L mm	Art.-Nr. Art. No.	
M12x1.5	2.5	6.5	15	21	12	1545.12.1.06	100
M16x1.5	2.0	6.0	19	25	15	1545.17.1.06	50
M16x1.5	4.5	10.0	19	25	15	1545.17.1.10	50
M20x1.5	3.5	8.0	24	29	15	1545.20.1.08	50
M20x1.5	7.0	13.0	24	29	15	1545.20.1.13	50
M25x1.5	5.0	11.0	29	38	15	1545.25.1.11	25
M25x1.5	10.0	17.0	29	38	15	1545.25.1.17	25
M32x1.5	17.0	25.0	42	36	15	1545.32.1.25	20
M40x1.5	22.0	33.0	53	48	15	1545.40.1.33	10
M50x1.5	28.0	38.0	60	48	15	1545.50.1.38	5
M63x1.5	32.0	44.0	65	49	16	1545.63.1.44	5

Kabelverschraubungen Syntec® Kunststoff mit Lamellentechneik

Synthetic cable glands Syntec® with lamellar technology

Anschlussgewinde Pg | Entry thread Pg

Material: Polyamid PA 6
 Eigenschaften: halogenfrei
 Dichtring: CR (Neopren)
 Einsatztemperatur: -30°C / +100°C
 Schutzart: IP 68

Material: Polyamide PA 6
 Properties: Halogen-free
 Sealing ring: CR (neoprene)
 Temperature range: -30°C / +100°C
 Protection class: IP 68

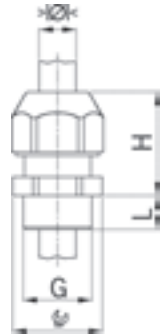

SYNTEC

Hellgrau RAL 7035 Einteiliger Dichtring		Light grey RAL 7035 One-piece sealing ring				
G	>Ø< min mm	>Ø< max mm	H mm	L mm	Art.-Nr. Art. No.	
Pg 7	2.5	6.5	15	21	8	1555.07.06 100
Pg 9	3.0	8.0	19	23	8	1555.09.08 50
Pg 11	2.0	7.0	22	25	8	1555.11.07 50
Pg 11	4.0	10.0	22	25	8	1555.11.10 50
Pg 13	3.0	7.0	24	26	9	1555.13.07 50
Pg 13	5.5	12.0	24	26	9	1555.13.12 50
Pg 16	5.0	11.0	27	30	10	1555.16.11 50
Pg 16	8.5	14.0	27	30	10	1555.16.14 50
Pg 21	6.5	14.0	33	35	11	1555.21.14 25
Pg 21	11.0	18.0	33	35	11	1555.21.18 25
Pg 29	17.0	25.0	42	36	11	1555.29.25 20
Pg 36	22.0	33.0	53	48	15	1555.36.33 10
Pg 42	28.0	38.0	60	48	15	1555.42.38 5
Pg 48	32.0	44.0	65	48	15	1555.48.44 5



SYNTEC

Dunkelgrau RAL 7001 Einteiliger Dichtring		Dark grey RAL 7001 One-piece sealing ring				
G	>Ø< min mm	>Ø< max mm	H mm	L mm	Art.-Nr. Art. No.	
Pg 7	2.5	6.5	15	21	8	1556.07.06 100
Pg 9	3.0	8.0	19	23	8	1556.09.08 50
Pg 11	2.0	7.0	22	25	8	1556.11.07 50
Pg 11	4.0	10.0	22	25	8	1556.11.10 50
Pg 13	3.0	7.0	24	26	9	1556.13.07 50
Pg 13	5.5	12.0	24	26	9	1556.13.12 50
Pg 16	5.0	11.0	27	30	10	1556.16.11 50
Pg 16	8.5	14.0	27	30	10	1556.16.14 50
Pg 21	6.5	14.0	33	35	11	1556.21.14 25
Pg 21	11.0	18.0	33	35	11	1556.21.18 25
Pg 29	17.0	25.0	42	36	11	1556.29.25 20
Pg 36	22.0	33.0	53	48	15	1556.36.33 10
Pg 42	28.0	38.0	60	48	15	1556.42.38 5
Pg 48	32.0	44.0	65	48	15	1556.48.44 5



Kabelverschraubungen Syntec® Kunststoff mit Lamellentechnik

Synthetic cable glands Syntec® with lamellar technology

Anschlussgewinde Pg | Entry thread Pg

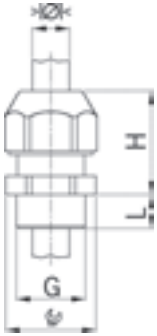

Material: Polyamid PA 6
 Eigenschaften: halogenfrei
 Dichtring: CR (Neopren)
 Einsatztemperatur: -30°C / +100°C
 Schutzart: IP 68

Material: Polyamide PA 6
 Properties: Halogen-free
 Sealing ring: CR (neoprene)
 Temperature range: -30°C / +100°C
 Protection class: IP 68





SYNTEC

Schwarz RAL 9005
 Einteiliger Dichtring

Black RAL 9005
 One-piece sealing ring



G	> Ø < min mm	> Ø < max mm		H mm	L mm	Art.-Nr. Art. No.	
Pg 7	2.5	6.5	15	21	8	1545.07.06	100
Pg 9	3.0	8.0	19	23	8	1545.09.08	50
Pg 11	2.0	7.0	22	25	8	1545.11.07	50
Pg 11	4.0	10.0	22	25	8	1545.11.10	50
Pg 13	3.0	7.0	24	26	9	1545.13.07	50
Pg 13	5.5	12.0	24	26	9	1545.13.12	50
Pg 16	5.0	11.0	27	30	10	1545.16.11	50
Pg 16	8.5	14.0	27	30	10	1545.16.14	50
Pg 21	6.5	14.0	33	35	11	1545.21.14	25
Pg 21	11.0	18.0	33	35	11	1545.21.18	25
Pg 29	17.0	25.0	42	36	11	1545.29.25	20
Pg 36	22.0	33.0	53	48	15	1545.36.33	10
Pg 42	28.0	38.0	60	48	15	1545.42.38	5
Pg 48	32.0	44.0	65	48	15	1545.48.44	5

Kabelverschraubungen Syntec® Kunststoff mit Lamellentechneik

Synthetic cable glands Syntec® with lamellar technology

Anschlussgewinde NPT | Entry thread NPT

Material: Polyamid PA 6
 Eigenschaften: halogenfrei
 Dichtring: CR (Neopren)
 Einsatztemperatur: -30°C / +100°C
 Schutzart: IP 54
 Weitere Schutzart: IP 68, wenn Anschluss-
 gewinde abgedichtet

Material: Polyamide PA 6
 Properties: Halogen-free
 Sealing ring: CR (neoprene)
 Temperature range: -30°C / +100°C
 Protection class: IP 54
 Further protection: IP 68, if the entry thread
 is sealed

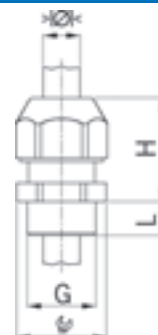

SYNTEC

Hellgrau RAL 7035 Einteiliger Dichtring		Light grey RAL 7035 One-piece sealing ring				Art.-Nr. Art. No.	
G	> Ø < min mm	> Ø < max mm		H mm	L mm		
NPT 3/8"	3.0	8.0	19/22	23	15	1555.N0375.08	50
NPT 1/2"	3.0	7.0	24	26	15	1555.N0500.07	50
NPT 1/2"	5.5	12.0	24	26	15	1555.N0500.12	50
NPT 3/4"	6.5	14.0	33	35	15	1555.N0750.14	25
NPT 3/4"	11.0	18.0	33	35	15	1555.N0750.18	25
NPT 1"	17.0	22.0	42	36	15	1555.N1000.22	20



SYNTEC

Dunkelgrau RAL 7001 Einteiliger Dichtring		Dark grey RAL 7001 One-piece sealing ring				Art.-Nr. Art. No.	
G	> Ø < min mm	> Ø < max mm		H mm	L mm		
NPT 3/8"	3.0	8.0	19/22	23	15	1556.N0375.08	50
NPT 1/2"	3.0	7.0	24	26	15	1556.N0500.07	50
NPT 1/2"	5.5	12.0	24	26	15	1556.N0500.12	50
NPT 3/4"	6.5	14.0	33	35	15	1556.N0750.14	25
NPT 3/4"	11.0	18.0	33	35	15	1556.N0750.18	25
NPT 1"	17.0	22.0	42	36	15	1556.N1000.22	20



SYNTEC

Schwarz RAL 9005 Einteiliger Dichtring		Black RAL 9005 One-piece sealing ring				Art.-Nr. Art. No.	
G	> Ø < min mm	> Ø < max mm		H mm	L mm		
NPT 3/8"	3.0	8.0	19/22	23	15	1545.N0375.08	50
NPT 1/2"	3.0	7.0	24	26	15	1545.N0500.07	50
NPT 1/2"	5.5	12.0	24	26	15	1545.N0500.12	50
NPT 3/4"	6.5	14.0	33	35	15	1545.N0750.14	25
NPT 3/4"	11.0	18.0	33	35	15	1545.N0750.18	25
NPT 1"	17.0	22.0	42	36	15	1545.N1000.22	20



Kabelverschraubungen Syntec® Kunststoff mit Lamellentechnik und Knickschutz Synthetic Syntec® cable glands with lamellar technology and anti-kink nozzle

Kurzes Anschlussgewinde metrisch | Short entry thread metric



Material: Polyamid PA 6
Eigenschaften: halogenfrei
Dichtring: CR (Neopren)
Einsatztemperatur: -30°C / +100°C
Schutzart: IP 68

Material: Polyamide PA 6
Properties: Halogen-free
Sealing ring: CR (neoprene)
Temperature range: -30°C / +100°C
Protection class: IP 68

SYNTEC mit Knickschutz



Hellgrau RAL 7035
Einteiliger Dichtring

Light grey RAL 7035
One-piece sealing ring

G	> Ø < min mm	> Ø < max mm	IP	H mm	L mm	Art.-Nr. Art. No.	
M12x1.5	2.5	6.5	15	54	6	1576.12.06	50
M16x1.5	4.0	8.0	19	64	6	1576.17.08	50
M20x1.5	3.0	7.0	24	88	8	1576.20.07	50
M20x1.5	5.5	12.0	24	88	8	1576.20.12	50



SYNTEC mit Knickschutz



Dunkelgrau RAL 7001
Einteiliger Dichtring

Dark grey RAL 7001
One-piece sealing ring

G	> Ø < min mm	> Ø < max mm	IP	H mm	L mm	Art.-Nr. Art. No.	
M12x1.5	2.5	6.5	15	54	6	1577.12.06	50
M16x1.5	4.0	8.0	19	64	6	1577.17.08	50
M20x1.5	3.0	7.0	24	88	8	1577.20.07	50
M20x1.5	5.5	12.0	24	88	8	1577.20.12	50



SYNTEC mit Knickschutz



Schwarz RAL 9005
Einteiliger Dichtring

Black RAL 9005
One-piece sealing ring

G	> Ø < min mm	> Ø < max mm	IP	H mm	L mm	Art.-Nr. Art. No.	
M12x1.5	2.5	6.5	15	54	6	1546.12.06	50
M16x1.5	4.0	8.0	19	64	6	1546.17.08	50
M20x1.5	3.0	7.0	24	88	8	1546.20.07	50
M20x1.5	5.5	12.0	24	88	8	1546.20.12	50



Kabelverschraubungen Syntec® Kunststoff mit Lamellentechnik und Knickschutz

Synthetic Syntec® cable glands with lamellar technology and anti-kink nozzle

Langes Anschlussgewinde metrisch | Long entry thread metric

Material: Polyamid PA 6
 Eigenschaften: halogenfrei
 Dichtring: CR (Neopren)
 Einsatztemperatur: -30°C / +100°C
 Schutzart: IP 68

Material: Polyamide PA 6
 Properties: Halogen-free
 Sealing ring: CR (neoprene)
 Temperature range: -30°C / +100°C
 Protection class: IP 68



SYNTEC mit Knickschutz



Hellgrau RAL 7035
 Einteiliger Dichtring

Light grey RAL 7035
 One-piece sealing ring

G	> Ø < min mm	> Ø < max mm	IP	H mm	L mm	Art.-Nr. Art. No.	
M12x1.5	2.5	6.5	15	54	12	1576.12.1.06	50
M16x1.5	4.0	8.0	19	64	12	1576.17.1.08	50
M20x1.5	3.0	7.0	24	88	13	1576.20.1.07	50
M20x1.5	5.5	12.0	24	88	13	1576.20.1.12	50



SYNTEC mit Knickschutz



Dunkelgrau RAL 7001
 Einteiliger Dichtring

Dark grey RAL 7001
 One-piece sealing ring

G	> Ø < min mm	> Ø < max mm	IP	H mm	L mm	Art.-Nr. Art. No.	
M12x1.5	2.5	6.5	15	54	12	1577.12.1.06	50
M16x1.5	4.0	8.0	19	64	12	1577.17.1.08	50
M20x1.5	3.0	7.0	24	88	13	1577.20.1.07	50
M20x1.5	5.5	12.0	24	88	13	1577.20.1.12	50



SYNTEC mit Knickschutz



Schwarz RAL 9005
 Einteiliger Dichtring

Black RAL 9005
 One-piece sealing ring

G	> Ø < min mm	> Ø < max mm	IP	H mm	L mm	Art.-Nr. Art. No.	
M12x1.5	2.5	6.5	15	54	12	1546.12.1.06	50
M16x1.5	4.0	8.0	19	64	12	1546.17.1.08	50
M20x1.5	3.0	7.0	24	88	13	1546.20.1.07	50
M20x1.5	5.5	12.0	24	88	13	1546.20.1.12	50



1
2
3
4
5
6
7
8
9
10
11
12

Kabelverschraubungen Syntec® Kunststoff mit Lamellentechnik und Knickschutz Synthetic Syntec® cable glands with lamellar technology and anti-kink nozzle

Anschlussgewinde Pg | Entry thread Pg



Material: Polyamid PA 6
Eigenschaften: halogenfrei
Dichtring: CR (Neopren)
Einsatztemperatur: -30°C / +100°C
Schutzart: IP 68

Material: Polyamide PA 6
Properties: Halogen-free
Sealing ring: CR (neoprene)
Temperature range: -30°C / +100°C
Protection class: IP 68



SYNTEC mit Knickschutz

Hellgrau RAL 7035
Einteiliger Dichtring

Light grey RAL 7035
One-piece sealing ring



G	>Ø< min mm	>Ø< max mm	IP	H mm	L mm	Art.-Nr. Art. No.	
Pg 7	2.5	6.5	15	54	8	1576.07.06	50
Pg 9	3.0	8.0	19	64	8	1576.09.08	50
Pg 11	2.0	7.0	22	77	8	1576.11.07	50
Pg 11	4.0	10.0	22	77	8	1576.11.10	50
Pg 13	3.0	7.0	24	88	9	1576.13.07	50
Pg 13	5.5	12.0	24	88	9	1576.13.12	50
Pg 16	5.0	11.0	27	102	10	1576.16.11	50
Pg 16	8.5	14.0	27	102	10	1576.16.14	50



SYNTEC mit Knickschutz

Dunkelgrau RAL 7001
Einteiliger Dichtring

Dark grey RAL 7001
One-piece sealing ring



G	>Ø< min mm	>Ø< max mm	IP	H mm	L mm	Art.-Nr. Art. No.	
Pg 7	2.5	6.5	15	54	8	1577.07.06	50
Pg 9	3.0	8.0	19	64	8	1577.09.08	50
Pg 11	2.0	7.0	22	77	8	1577.11.07	50
Pg 11	4.0	10.0	22	77	8	1577.11.10	50
Pg 13	3.0	7.0	24	88	9	1577.13.07	50
Pg 13	5.5	12.0	24	88	9	1577.13.12	50
Pg 16	5.0	11.0	27	102	10	1577.16.11	50
Pg 16	8.5	14.0	27	102	10	1577.16.14	50



SYNTEC mit Knickschutz

Schwarz RAL 9005
Einteiliger Dichtring

Black RAL 9005
One-piece sealing ring



G	>Ø< min mm	>Ø< max mm	IP	H mm	L mm	Art.-Nr. Art. No.	
Pg 7	2.5	6.5	15	54	8	1546.07.06	50
Pg 9	3.0	8.0	19	64	8	1546.09.08	50
Pg 11	2.0	7.0	22	77	8	1546.11.07	50
Pg 11	4.0	10.0	22	77	8	1546.11.10	50
Pg 13	3.0	7.0	24	88	9	1546.13.07	50
Pg 13	5.5	12.0	24	88	9	1546.13.12	50
Pg 16	5.0	11.0	27	102	10	1546.16.11	50
Pg 16	8.5	14.0	27	102	10	1546.16.14	50

Kabelverschraubungen Syntec® Kunststoff mit Lamellentechnik und Knickschutz Synthetic Syntec® cable glands with lamellar technology and anti-kink nozzle

Anschlussgewinde NPT | Entry thread NPT

Material: Polyamid PA 6
Eigenschaften: halogenfrei
Dichtring: CR (Neopren)
Einsatztemperatur: -30°C / +100°C
Schutzart: IP 54
Weitere Schutzart: IP 68, wenn Anschluss-
gewinde abgedichtet

Material: Polyamide PA 6
Properties: Halogen-free
Sealing ring: CR (neoprene)
Temperature range: -30°C / +100°C
Protection class: IP 54
Further protection: IP 68, if the entry thread
is sealed



SYNTEC mit Knickschutz



Hellgrau RAL 7035 Einteiliger Dichtring		Light grey RAL 7035 One-piece sealing ring			
G	> Ø < min mm	> Ø < max mm	H mm	L mm	Art.-Nr. Art. No.
NPT 3/8"	3.0	8.0	19/22	64	1576.N0375.08 50
NPT 1/2"	3.0	7.0	24	88	1576.N0500.07 50
NPT 1/2"	5.5	12.0	24	88	1576.N0500.12 50



SYNTEC mit Knickschutz



Dunkelgrau RAL 7001 Einteiliger Dichtring		Dark grey RAL 7001 One-piece sealing ring			
G	> Ø < min mm	> Ø < max mm	H mm	L mm	Art.-Nr. Art. No.
NPT 3/8"	3.0	8.0	19/22	64	1577.N0375.08 50
NPT 1/2"	3.0	7.0	24	88	1577.N0500.07 50
NPT 1/2"	5.5	12.0	24	88	1577.N0500.12 50



SYNTEC mit Knickschutz



Schwarz RAL 9005 Einteiliger Dichtring		Black RAL 9005 One-piece sealing ring			
G	> Ø < min mm	> Ø < max mm	H mm	L mm	Art.-Nr. Art. No.
NPT 3/8"	3.0	8.0	19/22	64	1546.N0375.08 50
NPT 1/2"	3.0	7.0	24	88	1546.N0500.07 50
NPT 1/2"	5.5	12.0	24	88	1546.N0500.12 50



1
2
3
4
5
6
7
8
9
10
11
12

Flanschwinkel und Winkel

Flanged elbows and elbows



Sind bei der Kabelinstallation enge Raumverhältnisse gegeben, kann der Anwender auf die Vorteile von **Winkeln und Flanschwinkeln** bauen. Hier werden Leitungen um die Ecke geführt und je nach der verwendeten Kabelverschraubung zu 100% vor der Knickstelle zugentlastet. Bei den Kunststoff-Flanschwinkeln erleichtert zudem ein spezieller Klappmechanismus die Kabelinstallation.

Die Quickseal Kabeleinführungstüllen sind spezielle Durchführungs-membranen und können auch als Verschlussstopfen verwendet werden. Zur Montage wird kein Werkzeug benötigt. Einfach Kabel-durchführung einstecken. Danach wird die geschlossene Membran durch Einstecken des durchzuführenden Kabels durchstossen.

Die Würgenippel aus Kunststoff sind für den Einsatz in Installations-bereichen ohne besonderen Einsatz bestens geeignet. Erhältlich mit und ohne Bohrung.

If space is at a premium the user can take advantage of the benefits of **elbows and flanged elbows** for cable installations.

The cables are run around the bend and, depending upon the type of cable gland used, completely relieved of any strain before the kinking point.

A special folding mechanism simplifies the cable installation for synthetic flanged elbows.

Quickseal cable grommets are unique feedthrough membranes which can also be used as sealing caps. No tools are needed for assembly – simply insert the cable grommet. Afterwards, you take the cable to be fed through and push it through the closed membrane.

These locking plugs made of plastic are especially well suited for use in electrical installations and require no special effort to use. Available with and without pre-drilled holes.



Winkel-Kabelverschraubungen 90° Kunststoff Synthetic cable glands elbow 90°		192
Flanschwinkel 90° Kunststoff Synthetic flanged elbow 90°		193
Quickseal Kabeleinführungstüllen Quickseal cable grommets		194
Würgenippel Kunststoff Synthetic locking plug		195

1

2

3

4

5

6

7

8

9

10

11

12

Winkel-Kabelverschraubungen 90° Kunststoff

Synthetic cable glands elbow 90°

Anschlussgewinde metrisch | Entry thread metric

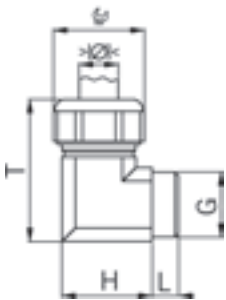

Material: Polyamid PA 6
 Dichtung: TPE
 Einsatztemperatur: -20°C / +100°C
 Schutzart: IP 68

Material: Polyamide PA 6
 Seal: TPE
 Temperature range: -20°C / +100°C
 Protection class: IP 68



Grau RAL 7032
 Einteiliger Dichteinsatz

Grey RAL 7032
 One-piece sealing insert

G	> Ø < min mm	> Ø < max mm	IP	H mm	T mm	L mm	Art.-Nr. Art. No.	
M16x1.5	6.5	9.5	19	23	38	8	5215.17.95	25
M20x1.5	7.0	10.5	24	28	46	9	5215.20.105	25
M20x1.5	9.0	13.0	24	28	46	9	5215.20.13	25
M25x1.5	11.5	15.5	27	32	52	10	5215.25.155	25



Schwarz RAL 9005
 Einteiliger Dichteinsatz

Black RAL 9005
 One-piece sealing insert

G	> Ø < min mm	> Ø < max mm	IP	H mm	T mm	L mm	Art.-Nr. Art. No.	
M16x1.5	6.5	9.5	19	23	38	8	5215.17.40.95	25
M20x1.5	7.0	10.5	24	28	46	9	5215.20.40.105	25
M20x1.5	9.0	13.0	24	28	46	9	5215.20.40.13	25
M25x1.5	11.5	15.5	27	32	52	10	5215.25.40.155	25

Anschlussgewinde Pg | Entry thread Pg



Grau RAL 7032
 Einteiliger Dichteinsatz

Grey RAL 7032
 One-piece sealing insert

G	> Ø < min mm	> Ø < max mm	IP	H mm	T mm	L mm	Art.-Nr. Art. No.	
Pg 9	4.5	6.5	19	23	38	8	5215.09.65	25
Pg 9	6.5	9.5	19	23	38	8	5215.09.95	25
Pg 11	7.0	10.5	22	25	42	9	5215.11.105	25
Pg 11	4.0	6.5	22	25	42	9	5215.11.65	25
Pg 11	6.5	9.5	22	25	42	9	5215.11.95	25
Pg 13	7.0	10.5	24	28	46	9	5215.13.105	25
Pg 13	9.0	13.0	24	28	46	9	5215.13.13	25
Pg 13	6.5	9.5	24	32	46	9	5215.13.95	25
Pg 16	7.0	10.5	27	32	52	10	5215.16.105	25
Pg 16	9.0	13.0	27	32	52	10	5215.16.13	25
Pg 16	11.5	15.5	27	32	52	10	5215.16.155	25
Pg 16	6.5	9.5	27	32	52	10	5215.16.95	25

Flanschwinkel 90° Kunststoff

Synthetic flanged elbow 90°

Anschlussgewinde metrisch | Entry thread metric

Material: Polyamid
 Dichtung: NBR
 Einsatztemperatur: -40°C / +110°C
 Schutzart: IP 65
 Eigenschaften: Der Flanschwinkel lässt sich zum Einführen der Kabel aufklappen und ermöglicht damit eine mühelose Montage

Material: Polyamide
 Seal: NBR
 Temperature range: -40°C / +110°C
 Protection class: IP 65
 Properties: The flanged elbow can be opened to insert the cables and therefore permits an effortless installation

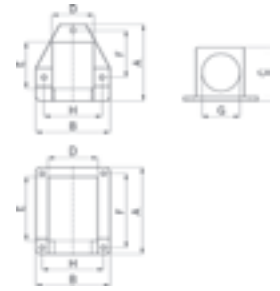

Grau	Grey							Art.-Nr. Art. No.	
G	A mm	B mm	C mm	D mm	E mm	F mm	H mm		
M16x1.5	49	47	35	22	27	29	37	5500.20.17	10
M20x1.5	49	47	35	22	27	29	37	5500.20.20	10
M25x1.5	69	65	44	30	31	42	52	5500.20.25	10
M32x1.5	90	78	55	40	65	65	65	5500.20.32	10
M40x1.5	100	94	66	48	68	80	80	5500.20.40	5
M50x1.5	116	101	76	63	85	88	88	5500.20.50	5



Schwarz	Black							Art.-Nr. Art. No.	
G	A mm	B mm	C mm	D mm	E mm	F mm	H mm		
M16x1.5	49	47	35	22	27	29	37	5500.40.17	10
M20x1.5	49	47	35	22	27	29	37	5500.40.20	10
M25x1.5	69	65	44	30	31	42	52	5500.40.25	10
M32x1.5	90	78	55	40	65	65	65	5500.40.32	10
M40x1.5	100	94	66	48	68	80	80	5500.40.40	5
M50x1.5	116	101	76	63	85	88	88	5500.40.50	5



Anschlussgewinde Pg | Entry thread Pg

Grau	Grey							Art.-Nr. Art. No.	
G	A mm	B mm	C mm	D mm	E mm	F mm	H mm		
Pg 11	49	47	35	22	27	29	37	5520.11	10
Pg 16	49	47	35	22	27	29	37	5520.16	10
Pg 21	69	65	44	30	31	42	52	5520.21	10
Pg 29	90	78	55	40	65	65	65	5520.29	10
Pg 36	100	94	66	48	68	80	80	5520.36	5
Pg 48	116	101	76	63	85	88	88	5520.48.48	5



Schwarz	Black							Art.-Nr. Art. No.	
G	A mm	B mm	C mm	D mm	E mm	F mm	H mm		
Pg 11	49	47	35	22	27	29	37	5540.11	10
Pg 16	49	47	35	22	27	29	37	5540.16	10
Pg 21	69	65	44	30	31	42	52	5540.21	10
Pg 29	90	78	55	40	65	65	65	5540.29	10
Pg 36	100	94	66	48	68	80	80	5540.36	5
Pg 48	116	101	76	63	85	88	88	5540.48.48	5



Quickseal Kabeleinführungstüllen

Quickseal cable grommets

Metrische Nenngrossen | Metric rating

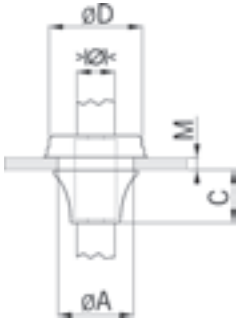

Material: EPDM
 Einsatztemperatur: -40°C / +110°C
 Schutzart: IP 67
 Eigenschaften: Halogenfrei, allseitig IP 67 durch 'Pushout-Membrane', gute Chemikalien- und Witterungsbeständigkeit
 Einsatzbereich: Universell einsetzbar bei Wandstärken von 1 bis 4mm (M16 - M50) bzw. 0.5 bis 2mm (M12)

Material: EPDM
 Temperature range: -40°C / +110°C
 Protection class: IP 67
 Properties: Halogen-free, all-round IP 67 protection thanks to the "pushout-membrane", resistant to chemicals and weatherproof
 Application: Suitable for holes in materials of 1-4mm (M16 - M50), or M12 from 0.5-2mm



Dunkelgrau RAL 7001						Dark grey RAL 7001		
$\varnothing A$ mm	$>\varnothing<$ min mm	$>\varnothing<$ max mm	M mm	C mm	$\varnothing D$ mm	Art.-Nr. Art. No.		
12.5	4.0	7.0	0.5-2	5.6	20.0	14.582.33		50
16.5	5.0	9.0	1-4	11.0	21.0	14.582.34		50
20.5	8.0	13.0	1-4	13.4	25.5	14.582.35		50
25.5	11.0	17.0	1-4	15.3	30.5	14.582.36		50
32.5	15.0	20.0	1-4	18.6	38.5	14.582.37		25
40.5	19.0	28.0	1-4	21.7	48.5	14.582.38		25
50.5	27.0	35.0	1-4	25.0	60.5	14.582.39		10



Hellgrau RAL 7035						Light grey RAL 7035		
$\varnothing A$ mm	$>\varnothing<$ min mm	$>\varnothing<$ max mm	M mm	C mm	$\varnothing D$ mm	Art.-Nr. Art. No.		
12.5	4.0	7.0	0.5-2	5.6	20.0	14.583.03		50
16.5	5.0	9.0	1-4	11.0	21.0	14.583.04		50
20.5	8.0	13.0	1-4	13.4	25.5	14.583.05		50
25.5	11.0	17.0	1-4	15.3	30.5	14.583.06		50
32.5	15.0	20.0	1-4	18.6	38.5	14.583.07		25
40.5	19.0	28.0	1-4	21.7	48.5	14.583.08		25
50.5	27.0	35.0	1-4	25.0	60.5	14.583.09		10



Schwarz RAL 9005						Black RAL 9005		
$\varnothing A$ mm	$>\varnothing<$ min mm	$>\varnothing<$ max mm	M mm	C mm	$\varnothing D$ mm	Art.-Nr. Art. No.		
12.5	4.0	7.0	0.5-2	5.6	20.0	14.582.93		50
16.5	5.0	9.0	1-4	11.0	21.0	14.582.94		50
20.5	8.0	13.0	1-4	13.4	25.5	14.582.95		50
25.5	11.0	17.0	1-4	15.3	30.5	14.582.96		50
32.5	15.0	20.0	1-4	18.6	38.5	14.582.97		25
40.5	19.0	28.0	1-4	21.7	48.5	14.582.98		25
50.5	27.0	35.0	1-4	25.0	60.5	14.582.99		10

Anschlussgewinde metrisch | Entry thread metric

Material: Polyethylen
 Einsatztemperatur: -20°C / +70°C
 Schutzart: IP 54

Material: Polyethylene
 Temperature range: -20°C / +70°C
 Protection class: IP 54

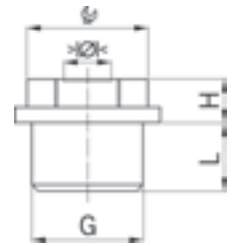

Hellgrau RAL 7035
 mit Bohrung

Light grey RAL 7035
 with bore hole

G	$\begin{matrix} > \varnothing < \\ \text{min mm} \end{matrix}$	$\begin{matrix} > \varnothing < \\ \text{max mm} \end{matrix}$		H mm	L mm	Art.-Nr. Art. No.	
M16x1.5	5.0	10.8	15	7	10	1620.17	100
M20x1.5	8.0	13.5	19	8	12	1620.20	100
M25x1.5	9.0	16.0	24	10	12	1620.25	100
M32x1.5	11.0	22.0	30	11	14	1620.32	50
M40x1.5	17.0	24.0	37	12	16	1620.40	25
M50x1.5	22.0	35.0	46	13	18	1620.50	10
M63x1.5	24.0	43.0	56	15	20	1620.63	10



Hellgrau RAL 7035
 ohne Bohrung

Light grey RAL 7035
 without bore hole

G	$\begin{matrix} > \varnothing < \\ \text{min mm} \end{matrix}$	$\begin{matrix} > \varnothing < \\ \text{max mm} \end{matrix}$		H mm	L mm	Art.-Nr. Art. No.	
M16x1.5	5.0	10.8	15	7	10	1600.17	100
M20x1.5	8.0	13.5	19	8	12	1600.20	100
M25x1.5	9.0	16.0	24	10	12	1600.25	100
M32x1.5	11.0	22.0	30	11	14	1600.32	100
M40x1.5	17.0	24.0	37	12	16	1600.40	25
M50x1.5	22.0	35.0	46	13	18	1600.50	10
M63x1.5	24.0	43.0	56	15	20	1600.63	10





Dank einer Reihe kleiner Helfer bei der Kabeleinführung lassen sich Produktionsanlagen problemlos an neue Aufgaben oder Gegebenheiten anpassen. Dabei kann nicht nur die Anzahl der Leitungen abweichen, sondern es können sich auch etliche Kabeldurchmesser ändern. Um hier den Arbeitsaufwand an Gehäusen und Schaltschränken zu minimieren, empfiehlt sich der Einsatz von Erweiterungen und Reduktionen. So können zum Beispiel einzelne Adern von dicken Kabeln durch eine Erweiterung in das Gehäuse eingeführt werden, wobei die äussere Leitungsisolierung in der Kabelverschraubung endet. Hierbei bleibt die vorhandene Schutzart selbstverständlich erhalten.

Überflüssige Gehäuseöffnungen werden durch den Einsatz von Verschlusschrauben abgedichtet und somit vor dem Eindringen von Schmutz bewahrt.

Falls keine Gewindebohrung vorhanden ist, können Gegenmuttern verwendet werden.

Thanks to a range of small accessories designed for the cable entry point, production systems can be easily adapted to take account of new tasks or new situations. Not only can the number of cables themselves change but cable diameters as well. To minimise the workload on housings and switchboard the use of extension or reduction fittings is recommended. An extension, for example, can be used to introduce the individual cores of thick cable into the housing with the outer cable insulation terminating in the cable gland. It goes without saying that the existing class of protection is maintained.

Redundant housing openings are sealed by locking screws to prevent the ingress of dirt.

If there is no tapped hole, locknuts can be used.



<p>Druckausgleichselemente Messing und Kunststoff Pressure balance elements nickel-plated brass and synthetics</p>		<p>198 - 200</p>
<p>Universal-Drehadapter und Richtungsfeststeller Messing Universal swivel adapter and adjustable fixing device nickel-plated brass</p>		<p>201</p>
<p>Gegenmuttern Metall Metal lock nuts</p>		<p>202 - 204</p>
<p>Gegenmuttern Kunststoff Synthetic lock nuts</p>		<p>205 - 206</p>
<p>Reduktionen und Erweiterungen Messing Reduction and enlarging fittings nickel-plated brass</p>		<p>207 - 215</p>
<p>Reduktionen und Erweiterungen Kunststoff Synthetic reduction and enlarging fittings</p>		<p>216 - 219</p>
<p>Verschlusschrauben Metall und Kunststoff Locking plugs metal and synthetic</p>		<p>220 - 224</p>
<p>Dichteinsätze Vollgummi Solid rubber sealing inserts</p>		<p>225</p>
<p>O-Ringe und Dichtungsscheiben O-rings and sealing washers</p>		<p>226 - 228</p>
<p>Blindscheiben, Verschlussbolzen, Einschnittringe Blind discs, locking pins, sealing rings</p>		<p>228 - 229</p>
<p>Spezialwerkzeug Special tool</p>		<p>230</p>
<p>AGRO Geflechschläuche Kunststoff AGRO synthetic braided cable sleeving</p>		<p>231 - 238</p>

1
2
3
4
5
6
7
8
9
10
11
12

Druckausgleichselement Messing und Kunststoff

Pressure balance element nickel-plated brass and synthetic

Anschlussgewinde metrisch | Entry thread metric

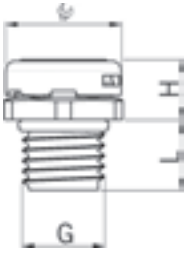

Kunststoff Druckausgleichselement mit Membrane

Material: Polyamid PA 6
 Membrane: PES Polyethersulfon
 O-Ring : NBR
 Einsatztemperatur: -40°C / +100°C
 Schutzart: IP 66 / IP 68 / IP 69K
 Wassereintrittsdruck: > 12.0 psi / 0.83 bar
 Luftdurchsatz: > 90ml / min / cm² bei 10mbar
 Eigenschaften: halogenfrei, UV beständig (getestet nach EN ISO 4892-2)

Synthetic pressure balance element with membrane

Material: Polyamide PA 6
 Membrane: PES polyethersulfone
 O-ring : NBR
 Temperature range: -40°C / +100°C
 Protection class: IP 66 / IP 68 / IP 69K
 Water intrusion pressure: > 12.0 psi / 0.83 bar
 Air flow rate: > 90ml / min / cm² at 10mbar
 Properties: halogen-free, UV resistant (tested according to EN ISO 4892-2)



mit Membrane
Schwarz

G		H mm	L mm
M12x1.5	17	9	10

Auf Anfrage lieferbar:
Hellgrau RAL 7035

with membrane
Black

Art.-Nr. | Art. No.
2445.12

 25

Available on request:
Light grey RAL 7035

Druckausgleichselement Messing und Kunststoff

Pressure balance element nickel-plated brass and synthetic

Anschlussgewinde metrisch | Entry thread metric

Druckausgleichselement Messing mit Membrane

Material:	Messing vernickelt
Membrane:	PES Polyethersulfon
O-Ring :	NBR
Einsatztemperatur:	-40°C / +110°C
Schutzart:	IP 66 / IP 68 / IP 69K
Wassereintrittsdruck:	> 12.0 psi / 0.83 bar
Luftdurchsatz:	> 90ml / min / cm ² bei 10mbar

Pressure balance element nickel-plated brass with membrane

Material:	Nickel-plated brass
Membrane:	PES polyethersulfone
O-ring :	NBR
Temperature range:	-40°C / +110°C
Protection class:	IP 66 / IP 68 / IP 69K
Water intrusion pressure:	> 12.0 psi / 0.83 bar
Air flow rate:	> 90ml / min / cm ² at 10mbar

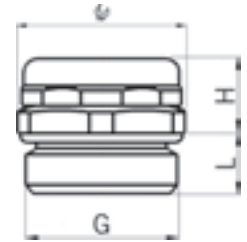

mit Membrane
mit O-Ring

G		H mm	L mm	Art.-Nr. Art. No.	
M12x1.5	18	9.5	8	2450.12.34	25
M16x1.5	18	9.5	8	2450.17.34	20
M20x1.5	22	10.0	8	2450.20.34	20

Auf Anfrage lieferbar:

Rostfreier Stahl A2 oder A4
Für hohe Temperaturen (+200°C)

with membrane
with O-ring

Available on request:

Stainless steel A2 or A4
For high temperature applications (+200°C)



Anschlussgewinde Pg | Entry thread Pg

mit Membrane
mit O-Ring

G		H mm	L mm	Art.-Nr. Art. No.	
Pg 7	18	9.5	8	2450.07.34	25
Pg 11	22	10.0	8	2450.11.34	20

Auf Anfrage lieferbar:

Rostfreier Stahl A2 oder A4
Für hohe Temperaturen (+200°C)

with membrane
with O-ring

Available on request:

Stainless steel A2 or A4
For high temperature applications (+200°C)



Anschlussgewinde metrisch | Entry thread metric

Druckausgleichselement Messing mit Sinterfilter

Material:	Messing vernickelt
Filterscheibe:	Sinterbronze
O-Ring :	NBR
Einsatztemperatur:	-50°C / +110°C
Schutzart:	IP 54 / IP x9K
Filtergrad:	40 µm

Pressure balance element nickel-plated brass with sintered filter

Material:	Nickel-plated brass
Filter disc:	Sintered bronze
O-ring :	NBR
Temperature range:	-50°C / +110°C
Protection class:	IP 54 / IP x9K
Degree of filter:	40 µm

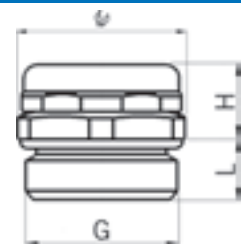

mit Sinterfilter
mit O-Ring

G		H mm	L mm	Art.-Nr. Art. No.	
M12x1.5	18	9.5	8	2450.12.32	25
M16x1.5	18	9.5	8	2450.17.32	20
M20x1.5	22	10.0	8	2450.20.32	20

Auf Anfrage lieferbar:

Rostfreier Stahl A2 oder A4
Für hohe Temperaturen (+200°C)

Sintered filter
with O-ring

Available on request:

Stainless steel A2 or A4
For high temperature applications (+200°C)



Druckausgleichselement Messing und Kunststoff

Pressure balance element nickel-plated brass and synthetic

Anschlussgewinde Pg | Entry thread Pg

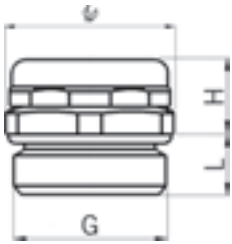

Druckausgleichselement Messing mit Sinterfilter

Material: Messing vernickelt
 Filterscheibe: Sinterbronze
 O-Ring : NBR
 Einsatztemperatur: -50°C / +110°C
 Schutzart: IP 54 / IP x9K
 Filtergrad: 40 µm

Pressure balance element nickel-plated brass with sintered filter

Material: Nickel-plated brass
 Filter disc: Sintered bronze
 O-ring : NBR
 Temperature range: -50°C / +110°C
 Protection class: IP 54 / IP x9K
 Degree of filter: 40 µm



mit Sinterfilter mit O-Ring				Sintered filter with O-ring			
G	IP	H mm	L mm	Art.-Nr. Art. No.	📦		
Pg 7	18	9.5	8	2450.07.32	25		
Pg 11	22	10.0	8	2450.11.32	20		
Auf Anfrage lieferbar: Rostfreier Stahl A2 oder A4 Für hohe Temperaturen (+200°C)				Available on request: Stainless steel A2 or A4 For high temperature applications (+200°C)			

Anschlussgewinde metrisch | Entry thread metric

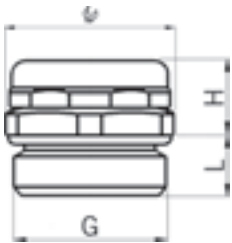

Entwässerungselement mit Sieb

Material: Messing vernickelt
 Sieb: Rostfreier Stahl A2
 O-Ring : NBR
 Einsatztemperatur: -50°C / +110°C
 Schutzart: IP 4x

Drainage element with mesh

Material: Nickel-plated brass
 Mesh: Stainless steel A2
 O-ring : NBR
 Temperature range: -50°C / +110°C
 Protection class: IP 4x



mit Sieb mit O-Ring				with mesh with O-ring			
G	IP	H mm	L mm	Art.-Nr. Art. No.	📦		
M12x1.5	18	9.5	10	2450.12.36	25		
M16x1.5	18	9.5	10	2450.17.36	20		
M20x1.5	22	10.0	10	2450.20.36	20		
Auf Anfrage lieferbar: Rostfreier Stahl A2 oder A4				Available on request: Stainless steel A2 or A4			

Anschlussgewinde metrisch | Entry thread metric

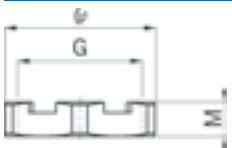

Gegenmutter zu Entwässerungselement

Material: Messing vernickelt
 Einsatztemperatur: -50°C / +200°C

Lock nut for drainage element

Material: Nickel-plated brass
 Temperature range: -50°C / +200°C



zum Entwässerungselement				for drainage element			
G	IP	M mm	Art.-Nr. Art. No.	📦			
M12x1.5	15	4.5	8324.12	25			
M16x1.5	19	5.5	8324.17	20			
M20x1.5	24	5.5	8324.20	20			

Richtungsfeststeller Messing

Adjustable fixing devices nickel-plated brass

Kurzes Anschlussgewinde metrisch | Short entry thread metric

AGRO Universal-Drehadapter Messing

Material: Messing vernickelt
 Dichtringe: NBR
 Einsatztemperatur: -40°C / +100°C
 Schutzart: IP 68
 Eigenschaften: Universell verwendbar mit Kabel- oder Schlauchverschraubungen, gute Drehfreudigkeit durch spezielle Lagerung

AGRO universal swivel adapter nickel-plated brass

Material: Nickel-plated brass
 Sealing rings: NBR
 Temperature range: -40°C / +100°C
 Protection class: IP 68
 Properties: Multifunctional use in combination with cable- or conduit glands, smooth rotation due to a special bearing

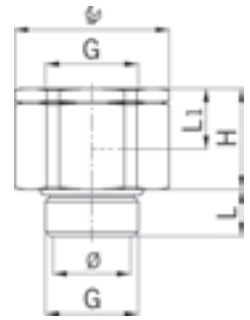

G		H mm	L mm	L1 mm	Ø mm	Art.-Nr. Art. No.	
M16x1.5	24	20	10	12	11.0	2410.17	25
M20x1.5	30	22	10	13	15.5	2410.20	25
M25x1.5	36	24	11	13	20.5	2410.25	25
M32x1.5	46	27	13	14	28.0	2410.32	10
M40x1.5	55	28	13	15	37.0	2410.40	10
M50x1.5	65	32	14	16.5	43.0	2410.50	5

Achtung! Der Universal-Drehadapter kann kein Kugel- oder Wälzlager ersetzen! Attention! The swivel adapter can not replace rolling- or ball bearings!



Anschlussgewinde metrisch | Entry thread metric

Material: Messing vernickelt
 O-Ring : 2 x NBR
 Einsatztemperatur: -30°C / +100°C
 Schutzart: IP 68
 Einsatzbereich: Besonders geeignet für die richtungsstabile Montage von Winkeln

Material: Nickel-plated brass
 O-ring : 2 x NBR
 Temperature range: -30°C / +100°C
 Protection class: IP 68
 Application: Suitable for directionally stable mounting of elbows

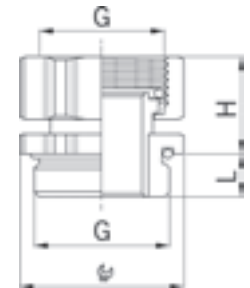

G		H mm	L mm	Art.-Nr. Art. No.	
M16x1.5	18	14	6	5000.17.50	50
M20x1.5	22	14	6	5000.20.50	50
M25x1.5	28	15	7	5000.25.50	50
M32x1.5	35	18	8	5000.32.50	50



Anschlussgewinde Pg | Entry thread Pg

G		H mm	L mm	Art.-Nr. Art. No.	
Pg 9	17	14	6	5009.50	50
Pg 11	20	14	6	5011.50	50
Pg 13	22	14	6	5013.50	50
Pg 16	24	16	6	5016.50	50
Pg 21	30	18	7	5021.50	25
Pg 29	40	19	8	5029.50	25



Gegenmuttern Messing

Lock nuts nickel-plated brass

Anschlussgewinde metrisch | Entry thread metric

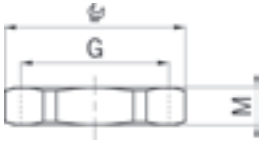

Material: Messing vernickelt
 Ausführung: 6-kant
 Einsatztemperatur: -40°C / +200°C

Material: Nickel-plated brass
 Execution: Hexagonal design
 Temperature range: -40°C / +200°C



Gewinde metrisch				Metric thread		
G	IC	M mm	i info	Art.-Nr. Art. No.		
M6x0.75	9	2.8	-	8000.06.1		50
M6x1.0	9	2.8	1	8000.06		50
M8x1.0	11	2.8	-	8000.08.1		50
M8x1.25	11	2.8	1	8000.08		50
M10x1.0	13	2.8	-	8000.10.1		50
M10x1.5	13	2.8	1	8000.10		50
M12x1.5	15	3.0	-	8000.12		100
M16x1.5	19	3.0	-	8000.17		100
M20x1.5	24	3.5	-	8000.20		100
M25x1.5	30	4.0	-	8000.25		50
M32x1.5	36	4.0	-	8000.32		25
M40x1.5	46	5.0	-	8000.40		25
M50x1.5	55	5.5	-	8000.50		10
M63x1.5	70	6.0	-	8000.63		10
M75x1.5	80	6.0	-	8000.75		10
M80x2.0	95	8	-	8000.080		5
M85x2.0	95	8.0	-	8000.085		5
M95x2.0	110	9.0	-	8000.095		5
M100x3.0	115	9.0	-	8000.100		1
M105x3.0	120	9.0	-	8000.105		1
M115x3.0	125	10.0	-	8000.115		1

1 = Metrisches Regelgewinde
 1 = Metric coarse-pitch thread

Anschlussgewinde Pg | Entry thread Pg



Gewinde Pg			Pg thread		
G	IC	M mm	Art.-Nr. Art. No.		
Pg 7	15	3.0	8007		50
Pg 9	18	3.0	8009		50
Pg 11	21	3.0	8011		50
Pg 13	23	3.0	8013		50
Pg 16	26	3.0	8016		50
Pg 21	32	3.5	8021		25
Pg 29	41	4.0	8029		10
Pg 36	51	5.0	8036		10
Pg 42	60	5.0	8042		10
Pg 48	64	5.5	8048.48		10

Anschlussgewinde Gasrohr | Gas-pipe entry thread



Gasrohr-Gewinde				Gas-pipe thread		
G	IC	M mm	i info	Art.-Nr. Art. No.		
G 3/8"	19	3.0	-	803/8G		10
G 1/2"	24	3.0	-	801/2G		10
G 5/8"	26	3.0	-	805/8G		10
G 3/4"	30	3.5	-	803/4G		10
G 1"	38	4.5	-	801G		10
G 1 1/2"	51	5.0	-	8011/2G		10
G 1 1/4"	46	5.0	-	8011/4G		10
G 2"	64	5.5	-	8048		10
G 2 1/2"	90	12.0	1	8050		50
G 3"	105	12.0	1	8051		50

1 = Runde Bauform, Stahl verzinkt
 1 = Round form, zinc coated steel

Anschlussgewinde metrisch | Entry thread metric

Gegenmuttern Messing, dicke Ausführung

Lock nuts nickel-plated brass, thick-walled version

Material: Messing vernickelt
 Ausführung: 6-kant
 Einsatztemperatur: -40°C / +200°C

Material: Nickel-plated brass
 Execution: Hexagonal design
 Temperature range: -40°C / +200°C

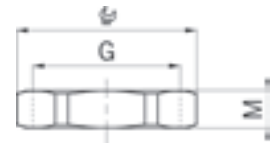

Dicke Ausführung			Thick-walled version		Art.-Nr. Art. No.	
G		M mm				
M12x1.5	15	5.0			50	8300.12
M16x1.5	19	5.0			50	8300.17
M20x1.5	24	5.5			50	8300.20
M25x1.5	30	5.5			50	8300.25
M32x1.5	36	6.0			50	8300.32
M40x1.5	46	7.0			50	8300.40



Anschlussgewinde Pg | Entry thread Pg

Dicke Ausführung			Thick-walled version		Art.-Nr. Art. No.	
G		M mm				
Pg 7	15	5.0			50	8300.07
Pg 9	18	5.0			50	8300.09
Pg 11	21	5.0			50	8300.11
Pg 13	24	5.5			50	8300.13
Pg 16	26	5.5			50	8300.16
Pg 21	32	6.0			50	8300.21
Pg 29	41	7.0			50	8300.29



Anschlussgewinde metrisch | Entry thread metric

Gegenmuttern Messing mit Hinterstich für O-Ring

Lock nuts nickel-plated brass with recess for O-ring

Material: Messing vernickelt
 Ausführung: 6-kant
 O-Ring : Separat bestellen
 Einsatztemperatur: -40°C / +200°C

Material: Nickel-plated brass
 Execution: Hexagonal design
 O-ring : To be ordered separately
 Temperature range: -40°C / +200°C

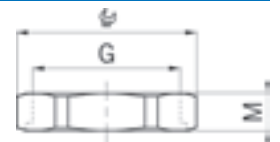

Dicke Ausführung ohne O-Ring				Thick-walled version without O-Ring		Art.-Nr. Art. No.	
G		M mm	O-ring				
M12x1.5	15	5.0	1007.00.08		50	8300.12.1	
M16x1.5	19	5.0	1016.00.15.08		50	8300.17.1	
M20x1.5	24	5.5	1016.00.08		50	8300.20.1	
M25x1.5	30	5.5	1013.00.22.08		50	8300.25.1	
M32x1.5	36	6.0	1021.00.30.08		50	8300.32.1	
M40x1.5	46	7.0	1029.00.39.08		50	8300.40.1	
M50x1.5	55	7.5	1036.00.49.08		10	8300.50.1	
M63x1.5	70	8.0	1048.00.62.08		10	8300.63.1	



1
2
3
4
5
6
7
8
9
10
11
12

Gegenmuttern rostfreier Stahl

Stainless steel lock nuts

Rostfreier Stahl A2 | Stainless steel A2

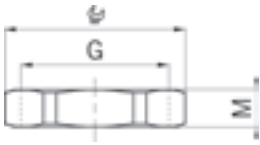

Material: Rostfreier CrNi-Stahl A2 (DIN EN 1.4305 / AISI 303)
 Ausführung: 6-kant
 Einsatztemperatur: -40°C / +300°C

Material: CrNi stainless steel A2 (DIN EN 1.4305 / AISI 303)
 Execution: Hexagonal design
 Temperature range: -40°C / +300°C



Gewinde metrisch

Metric thread

G	IC	M mm	i info	Art.-Nr. Art. No.	
M8x1.25	11	2.8	1	8008.96	50
M10x1.5	13	2.8	1	8010.96	50
M12x1.5	17	3.0	-	8012.96	50
M16x1.5	19	3.0	-	8017.96	50
M20x1.5	24	3.5	-	8020.96	50
M25x1.5	30	3.5	-	8025.96	25
M32x1.5	36	4.5	-	8032.96	25
M40x1.5	46	4.5	-	8040.96	10
M50x1.5	55	5.5	-	8050.96	10
M63x1.5	70	6.0	-	8063.96	5

1 = Metrisches Regelgewinde

1 = Metric coarse-pitch thread



Gewinde Pg

Pg thread

G	IC	M mm	Art.-Nr. Art. No.	
Pg 7	17	3.5	8007.96	50
Pg 9	19	3.5	8009.96	50
Pg 11	22	3.5	8011.96	50
Pg 13	24	4.0	8013.96	50
Pg 16	27	4.0	8016.96	50
Pg 21	32	4.5	8021.96	25
Pg 29	41	5.5	8029.96	10
Pg 36	51	6.0	8036.96	10

Rostfreier und säurebeständiger Stahl A4 | Stainless steel and acid resistant A4

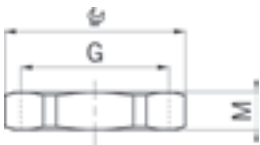

Material: Rostfreier und säurebeständiger CrNiMo-Stahl A4 (DIN EN 1.4435 / AISI 316L)
 Ausführung: 6-kant
 Einsatztemperatur: -40°C / +300°C

Material: Stainless and acid resistant steel A4 CrNiMo (DIN EN 1.4435 / AISI 316L)
 Execution: Hexagonal design
 Temperature range: -40°C / +300°C



Gewinde metrisch

Metric thread

G	IC	M mm	i info	Art.-Nr. Art. No.	
M8x1.25	11	2.8	1	8008.98	50
M10x1.5	13	2.8	1	8010.98	50
M12x1.5	17	3.0	-	8012.98	50
M16x1.5	19	3.0	-	8017.98	50
M20x1.5	24	3.5	-	8020.98	50
M25x1.5	30	3.5	-	8025.98	25
M32x1.5	36	4.5	-	8032.98	25
M40x1.5	46	4.5	-	8040.98	10
M50x1.5	55	5.5	-	8050.98	10
M63x1.5	70	6.0	-	8063.98	5

1 = Metrisches Regelgewinde

1 = Metric coarse-pitch thread

Anschlussgewinde metrisch | Entry thread metric

Material: Polyamid glasfaserverstärkt
 Ausführung: 6-kant
 Einsatztemperatur: -40°C / +100°C

Material: Polyamide glass fiber reinforced
 Execution: Hexagonal design
 Temperature range: -40°C / +100°C

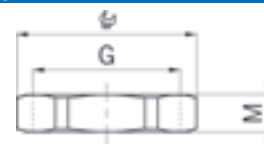

Hellgrau RAL 7035			Light grey RAL 7035		
G		M mm	Art.-Nr. Art. No.		
M12x1.5	17	5.5	8212	100	
M16x1.5	22	5.5	8217	100	
M20x1.5	26	6.5	8220	100	
M25x1.5	32	7.0	8225	100	
M32x1.5	41	7.0	8232	100	
M40x1.5	50	7.0	8240	50	
M50x1.5	60	8.5	8250	10	



Schwarz RAL 9005			Black RAL 9005		
G		M mm	Art.-Nr. Art. No.		
M12x1.5	17	5.5	8212.40	100	
M16x1.5	22	5.5	8217.40	100	
M20x1.5	26	6.5	8220.40	100	
M25x1.5	32	7.0	8225.40	100	
M32x1.5	41	7.0	8232.40	100	
M40x1.5	50	7.0	8240.40	50	
M50x1.5	60	8.5	8250.40	10	



Anschlussgewinde Pg | Entry thread Pg

Hellgrau RAL 7035			Light grey RAL 7035		
G		M mm	Art.-Nr. Art. No.		
Pg 7	19	5.0	8207	100	
Pg 9	22	6.0	8209	100	
Pg 11	24	6.0	8211	100	
Pg 13	27	6.0	8213	100	
Pg 16	30	6.0	8216	100	
Pg 21	36	7.0	8221	100	
Pg 29	46	7.0	8229	50	
Pg 36	60	8.0	8236	25	
Pg 42	65	8.0	8242	25	
Pg 48	70	8.0	8248.48	25	



Schwarz RAL 9005			Black RAL 9005		
G		M mm	Art.-Nr. Art. No.		
Pg 7	19	5.0	8207.40	100	
Pg 9	22	6.0	8209.40	100	
Pg 11	24	6.0	8211.40	100	
Pg 13	27	6.0	8213.40	100	
Pg 16	30	6.0	8216.40	100	
Pg 21	36	7.0	8221.40	100	
Pg 29	46	7.0	8229.40	50	
Pg 36	60	8.0	8236.40	25	
Pg 42	65	8.0	8242.40	25	
Pg 48	70	8.0	8248.48.40	25	



Gegenmuttern Kunststoff

Synthetic lock nuts

Anschlussgewinde metrisch | Entry thread metric

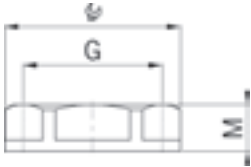

Gegenmuttern Kunststoff mit Flansch

Material: Polyamid PA 6
 Eigenschaften: halogenfrei
 Ausführung: 6-kant mit Flansch
 Einsatztemperatur: -30°C / +100°C

Synthetic lock nuts with flange

Material: Polyamide PA 6
 Properties: Halogen-free
 Execution: Hexagonal design with flange
 Temperature range: -30°C / +100°C



Hellgrau RAL 7035

G	IC	M mm	Art.-Nr. Art. No.	
M12x1.5	17	5.0	8255.12	100
M16x1.5	22	5.0	8255.17	100
M20x1.5	27	6.0	8255.20	100
M25x1.5	33	6.7	8255.25	100
M32x1.5	42	7.9	8255.32	50
M40x1.5	48	8.4	8255.40	50
M50x1.5	59	9.9	8255.50	10
M63x1.5	73	11.0	8255.63	10

Light grey RAL 7035



Schwarz RAL 9005

G	IC	M mm	Art.-Nr. Art. No.	
M12x1.5	17	5.0	8245.12	100
M16x1.5	22	5.0	8245.17	100
M20x1.5	27	6.0	8245.20	100
M25x1.5	33	6.7	8245.25	100
M32x1.5	42	7.9	8245.32	50
M40x1.5	48	8.4	8245.40	50
M50x1.5	59	9.9	8245.50	10
M63x1.5	73	11.0	8245.63	10

Black RAL 9005

Anschlussgewinde Pg | Entry thread Pg



Hellgrau RAL 7035

G	IC	M mm	Art.-Nr. Art. No.	
Pg 7	19	5.0	8255.07	100
Pg 9	21	5.0	8255.09	100
Pg 11	24	5.0	8255.11	100
Pg 13	27	6.0	8255.13	100
Pg 16	30	6.0	8255.16	100
Pg 21	36	7.0	8255.21	50
Pg 29	46	8.0	8255.29	50
Pg 36	59	8.0	8255.36	25
Pg 42	65	8.0	8255.42	10
Pg 48	69	8.0	8255.48	10

Light grey RAL 7035



Schwarz RAL 9005

G	IC	M mm	Art.-Nr. Art. No.	
Pg 7	19	5.0	8245.07	100
Pg 9	21	5.0	8245.09	100
Pg 11	24	5.0	8245.11	100
Pg 13	27	6.0	8245.13	100
Pg 16	30	6.0	8245.16	100
Pg 21	36	7.0	8245.21	50
Pg 29	46	8.0	8245.29	50
Pg 36	59	8.0	8245.36	25
Pg 42	65	8.0	8245.42	10
Pg 48	69	8.0	8245.48	10

Black RAL 9005

Reduktionen und Erweiterungen Messing

Reduction and enlarging fittings nickel-plated brass

mit 6-kant | hexagonal

Reduktionen Messing

Material: Messing vernickelt
O-Ring : NBR
Einsatztemperatur: -40°C / +100°C
Schutzart: IP 68

Reduction fittings nickel-plated brass

Material: Nickel-plated brass
O-ring : NBR
Temperature range: -40°C / +100°C
Protection class: IP 68

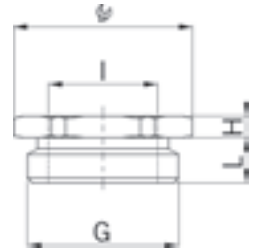

Aussengewinde metrisch
Innengewinde metrisch
mit O-Ring

Outer thread metric
Inner thread metric
with O-ring

G	I		H mm	L mm	i info	Art.-Nr. Art. No.	
M 8x1.25	M 6x1.0	11	8.0	5	1	3500.08.06	50
M 10x1.5	M 6x1.0	13	3.0	5	1	3500.10.06	50
M 10x1.5	M 8x1.25	13	8.0	5	1	3500.10.08	50
M 12x1.5	M 8x1.25	15	3.0	5	1	3500.12.08	50
M 12x1.5	M 10x1.5	15	8.0	5	1	3500.12.10	50
M 16x1.5	M 10x1.5	18	3.0	5	1	3500.17.10	50
M 16x1.5	M 12x1.5	18	3.0	5	-	3500.17.12	50
M 20x1.5	M 12x1.5	24	3.0	6	-	3500.20.12	50
M 20x1.5	M 16x1.5	24	3.0	6	-	3500.20.17	50
M 25x1.5	M 16x1.5	30	3.5	7	-	3500.25.17	25
M 25x1.5	M 20x1.5	30	3.5	7	-	3500.25.20	25
M 32x1.5	M 20x1.5	36	4.0	8	-	3500.32.20	20
M 32x1.5	M 25x1.5	36	4.0	8	-	3500.32.25	20
M 40x1.5	M 25x1.5	46	4.5	8	-	3500.40.25	10
M 40x1.5	M 32x1.5	46	4.5	8	-	3500.40.32	10
M 50x1.5	M 32x1.5	55	5.0	9	-	3500.50.32	10
M 50x1.5	M 40x1.5	55	5.0	9	-	3500.50.40	10
M 63x1.5	M 40x1.5	70	5.5	10	-	3500.63.40	5
M 63x1.5	M 50x1.5	70	5.5	10	-	3500.63.50	5
M 75x1.5	M 50x1.5	80	6.0	11	-	3500.75.50	5
M 75x1.5	M 63x1.5	80	6.0	11	-	3500.75.63	5

1 = Metrisches Regelgewinde

1 = Metric coarse-pitch thread

Runde Bauform, randriert | Round, knurled

Reduktionen Messing

Material: Messing vernickelt
Einsatztemperatur: -40°C / +200°C
Schutzart: IP 54
Weitere Schutzart: IP 68, wenn Anschluss-
gewinde abgedichtet

Reduction fittings nickel-plated brass

Material: Nickel-plated brass
Temperature range: -40°C / +200°C
Protection class: IP 54
Further protection: IP 68, if the entry thread
is sealed

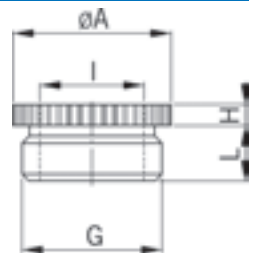

Aussengewinde metrisch
Innengewinde metrisch
ohne O-Ring

Outer thread metric
Inner thread metric
without O-Ring

G	I	ØA mm	H mm	L mm	Art.-Nr. Art. No.	
M 16x1.5	M 12x1.5	18	3	7	3545.17.12	100
M 20x1.5	M 12x1.5	22	3	8	3545.20.12	100
M 20x1.5	M 16x1.5	22	3	8	3545.20.17	100
M 25x1.5	M 16x1.5	27	3	8	3545.25.17	50
M 25x1.5	M 20x1.5	27	3	8	3545.25.20	50
M 32x1.5	M 20x1.5	34	4	9	3545.32.20	50
M 32x1.5	M 25x1.5	34	4	9	3545.32.25	50
M 40x1.5	M 25x1.5	42	4.5	9	3545.40.25	50
M 40x1.5	M 32x1.5	42	4.5	9	3545.40.32	25
M 50x1.5	M 32x1.5	52	4.5	10	3545.50.32	25
M 50x1.5	M 40x1.5	52	4.5	10	3545.50.40	10
M 63x1.5	M 40x1.5	65	5	11	3545.63.40	10
M 63x1.5	M 50x1.5	65	5	11	3545.63.50	10

Reduktionen und Erweiterungen Messing

Reduction and enlarging fittings nickel-plated brass

mit 6-kant | hexagonal

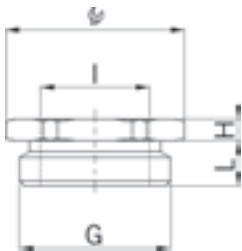

Reduktionen Messing

Material: Messing vernickelt
 O-Ring : NBR
 Einsatztemperatur: -40°C / +100°C
 Schutzart: IP 68

Reduction fittings nickel-plated brass

Material: Nickel-plated brass
 O-ring : NBR
 Temperature range: -40°C / +100°C
 Protection class: IP 68

Aussengewinde Pg
 Innengewinde Pg
 mit O-Ring

Outer thread Pg
 Inner thread Pg
 with O-ring

G	I	H	L	Art.-Nr. Art. No.	
		mm	mm		
Pg 9	Pg 7	18	3.0	3509.07	50
Pg 11	Pg 7	20	3.0	3511.07	50
Pg 11	Pg 9	22	3.0	3511.09	50
Pg 13	Pg 7	24	3.0	3513.07	50
Pg 13	Pg 9	24	3.0	3513.09	50
Pg 13	Pg 11	24	3.0	3513.11	50
Pg 16	Pg 9	24	3.0	3516.09	50
Pg 16	Pg 11	24	3.0	3516.11	50
Pg 16	Pg 13	27	3.0	3516.13	50
Pg 21	Pg 11	32	3.5	3521.11	25
Pg 21	Pg 13	32	3.5	3521.13	25
Pg 21	Pg 16	32	3.5	3521.16	25
Pg 29	Pg 13	38	4.0	3529.13	10
Pg 29	Pg 16	38	4.0	3529.16	10
Pg 29	Pg 21	38	4.0	3529.21	10
Pg 36	Pg 21	50	4.5	3536.21	10
Pg 36	Pg 29	50	4.5	3536.29	10
Pg 42	Pg 29	60	4.0	3542.29	10
Pg 42	Pg 36	60	4.0	3542.36	10
Pg 48	Pg 36	65	4.0	3548.48.36	10

Reduktionen und Erweiterungen Messing

Reduction and enlarging fittings nickel-plated brass

mit 6-kant | hexagonal

Erweiterungen Messing

Material: Messing vernickelt
 O-Ring : NBR
 Einsatztemperatur: -40°C / +100°C
 Schutzart: IP 68

Enlarging fittings nickel-plated brass

Material: Nickel-plated brass
 O-ring : NBR
 Temperature range: -40°C / +100°C
 Protection class: IP 68

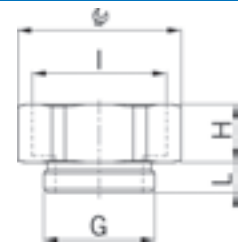

Aussengewinde metrisch
 Innengewinde metrisch
 mit O-Ring

Outer thread metric
 Inner thread metric
 with O-ring

G	I		H mm	L mm	i info	Art.-Nr. Art. No.	
M 6x1.0	M 8x1.25	11	8.5	5	1	3600.06.08	50
M 6x1.0	M 10x1.5	13	8.5	5	1	3600.06.10	50
M 8x1.25	M 10x1.5	13	9	5	1	3600.08.10	50
M 8x1.25	M 12x1.5	15	9	5	1	3600.08.12	50
M 10x1.5	M 12x1.5	15	9	5	1	3600.10.12	50
M 10x1.5	M 16x1.5	18	9	5	1	3600.10.17	50
M 12x1.5	M 16x1.5	18	9	5	-	3600.12.17	50
M 12x1.5	M 20x1.5	24	10	5	-	3600.12.20	50
M 16x1.5	M 20x1.5	24	10	5	-	3600.17.20	50
M 20x1.5	M 25x1.5	30	11.5	6	-	3600.20.25	25
M 25x1.5	M 32x1.5	36	14	7	-	3600.25.32	25
M 32x1.5	M 40x1.5	46	14	8	-	3600.32.40	25
M 40x1.5	M 50x1.5	55	16	8	-	3600.40.50	10
M 50x1.5	M 63x1.5	70	17	9	-	3600.50.63	10
M 63x1.5	M 75x1.5	80	18	10	-	3600.63.75	10

1 = Metrisches Regelgewinde

1 = Metric coarse-pitch thread

Runde Bauform | Round execution

Erweiterungen Messing

Material: Messing vernickelt
 Einsatztemperatur: -40°C / +200°C
 Schutzart: IP 54
 Weitere Schutzart: IP 68, wenn Anschluss-
 gewinde abgedichtet

Enlarging fittings nickel-plated brass

Material: Nickel-plated brass
 Temperature range: -40°C / +200°C
 Protection class: IP 54
 Further protection: IP 68, if the entry thread
 is sealed

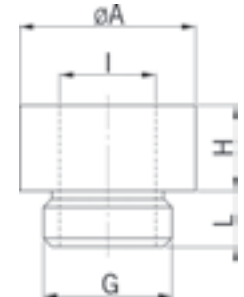

Aussengewinde metrisch
 Innengewinde metrisch
 ohne O-Ring

Outer thread metric
 Inner thread metric
 without O-Ring

G	I	ØA mm	H mm	L mm	Art.-Nr. Art. No.	
M 12x1.5	M 16x1.5	19	9.5	6.5	3645.12.17	100
M 16x1.5	M 20x1.5	22	10.5	7	3645.17.20	100
M 20x1.5	M 25x1.5	27	11	8	3645.20.25	100
M 25x1.5	M 32x1.5	34	12	8	3645.25.32	50
M 32x1.5	M 40x1.5	42	12	9	3645.32.40	50
M 40x1.5	M 50x1.5	53	14	9	3645.40.50	25
M 50x1.5	M 63x1.5	66	19	10	3645.50.63	25

1
2
3
4
5
6
7
8
9
10
11
12

Reduktionen und Erweiterungen Messing

Reduction and enlarging fittings nickel-plated brass

mit 6-kant | hexagonal

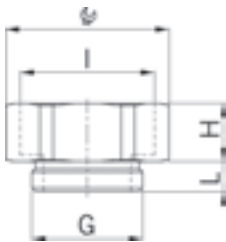

Erweiterungen Messing

Material: Messing vernickelt
 O-Ring : NBR
 Einsatztemperatur: -40°C / +100°C
 Schutzart: IP 68

Enlarging fittings nickel-plated brass

Material: Nickel-plated brass
 O-ring : NBR
 Temperature range: -40°C / +100°C
 Protection class: IP 68

Aussengewinde Pg
 Innengewinde Pg
 mit O-Ring

Outer thread Pg
 Inner thread Pg
 with O-ring

G	I	Pg	H mm	L mm	Art.-Nr. Art. No.	
Pg 7	Pg 9	18	13	8	3607.09.08	50
Pg 9	Pg 11	22	15	8	3609.11.08	50
Pg 9	Pg 13	24	15	8	3609.13.08	50
Pg 11	Pg 13	24	15	8	3611.13.08	50
Pg 11	Pg 16	24	15	8	3611.16.08	50
Pg 11	Pg 21	32	16	8	3611.21.08	50
Pg 13	Pg 16	24	15	8	3613.16.08	50
Pg 13	Pg 21	32	16	8	3613.21.08	50
Pg 16	Pg 21	32	16	8	3616.21.08	25
Pg 16	Pg 29	40	16	8	3616.29.08	25
Pg 21	Pg 29	40	16	8	3621.29.08	25
Pg 29	Pg 36	50	18	10	3629.36.08	20
Pg 36	Pg 42	60	19	12	3636.42.08	10
Pg 36	Pg 48	64	20	12	3636.48.48.08	10

mit 6-kant | hexagonal

Material: Messing vernickelt
 O-Ring : NBR
 Einsatztemperatur: -40°C / +100°C
 Schutzart: IP 68

Material: Nickel-plated brass
 O-ring : NBR
 Temperature range: -40°C / +100°C
 Protection class: IP 68

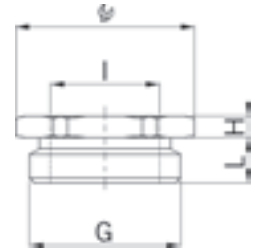

Aussengewinde metrisch
 Innengewinde Pg
 mit O-Ring

Outer thread metric
 Inner thread Pg
 with O-ring

G	I		H mm	L mm	Art.-Nr. Art. No.	
M16x1.5	Pg 7	20	3.0	7	3500.17.07	50
M20x1.5	Pg 7	24	3.0	7	3500.20.07	50
M20x1.5	Pg 9	24	3.0	7	3500.20.09	50
M20x1.5	Pg 11	24	10.0	7	3500.20.11	50
M25x1.5	Pg 9	30	3.5	8	3500.25.09	50
M25x1.5	Pg 11	30	3.5	8	3500.25.11	50
M25x1.5	Pg 13	30	3.8	8	3500.25.13	50
M25x1.5	Pg 16	30	15.0	8	3500.25.16	25
M32x1.5	Pg 21	38	16.0	8	3500.32.21	25
M40x1.5	Pg 29	45	16.0	8	3500.40.29	10
M50x1.5	Pg 29	55	4.0	10	3500.50.29	10
M63x1.5	Pg 36	70	5.5	11	3500.63.36	10



Aussengewinde metrisch
 Innengewinde Pg
 mit O-Ring

Outer thread metric
 Inner thread Pg
 with O-ring

G	I		H mm	L mm	i info	Art.-Nr. Art. No.	
M10x1.5	Pg 7	16	12	6	1	3600.10.07	50
M10x1.5	Pg 9	18	12	6	1	3600.10.09	50
M12x1.5	Pg 9	18	12	7	-	3600.12.09	50
M16x1.5	Pg 11	22	14	7	-	3600.17.11	50
M20x1.5	Pg 13	24	15	7	-	3600.20.13	50
M20x1.5	Pg 16	24	15	7	-	3600.20.16	50
M25x1.5	Pg 21	32	16	8	-	3600.25.21	25
M32x1.5	Pg 29	40	16	8	-	3600.32.29	25
M40x1.5	Pg 36	50	18	8	-	3600.40.36	20
M50x1.5	Pg 42	60	19	10	-	3600.50.42	10
M50x1.5	Pg 48	64	20	10	-	3600.50.48	10



1 = Metrisches Regelgewinde

1 = Metric coarse-pitch thread

Adapter Messing

Adapter nickel-plated brass

mit 6-kant | hexagonal

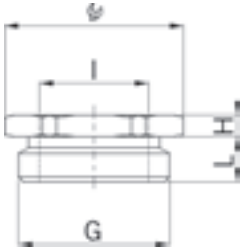

Material: Messing vernickelt
 O-Ring : NBR
 Einsatztemperatur: -40°C / +100°C
 Schutzart: IP 68

Material: Nickel-plated brass
 O-ring : NBR
 Temperature range: -40°C / +100°C
 Protection class: IP 68



Aussengewinde Pg
 Innengewinde metrisch
 mit O-Ring

Outer thread Pg
 Inner thread metric
 with O-ring

G	I		H mm	L mm	i info	Art.-Nr. Art. No.	
Pg 7	M 6x1.0	15	3.0	6	1	3500.07.06	50
Pg 7	M 8x1.25	15	3.0	6	1	3500.07.08	50
Pg 7	M10x1.5	15	7.0	6	1	3500.07.10	50
Pg 9	M 6x1.0	18	3.0	6	1	3500.09.06	50
Pg 9	M 8x1.25	18	3.0	6	1	3500.09.08	50
Pg 9	M10x1.5	18	3.0	6	1	3500.09.10	50
Pg 9	M12x1.5	18	8.0	6	-	3500.09.12	50
Pg 11	M 6x1.0	21	3.0	6	1	3500.11.06	50
Pg 11	M 8x1.25	21	3.0	6	1	3500.11.08	50
Pg 11	M10x1.5	21	3.0	6	1	3500.11.10	50
Pg 11	M12x1.5	21	3.0	6	-	3500.11.12	50
Pg 11	M16x1.5	21	8.0	6	-	3500.11.17	50
Pg 13	M12x1.5	24	3.0	6	-	3500.13.12	50
Pg 13	M16x1.5	24	3.0	6	-	3500.13.17	50
Pg 16	M12x1.5	24	3.0	6	-	3500.16.12	25
Pg 16	M16x1.5	24	3.0	6	-	3500.16.17	25
Pg 16	M20x1.5	24	10.5	6	-	3500.16.20	25
Pg 21	M16x1.5	30	3.5	7.5	-	3500.21.17	25
Pg 21	M20x1.5	30	3.5	7.5	-	3500.21.20	25
Pg 21	M25x1.5	30	10.5	7.5	-	3500.21.25	25
Pg 29	M25x1.5	38	4.0	8	-	3500.29.25	20
Pg 29	M32x1.5	38	13.0	8	-	3500.29.32	20
Pg 36	M32x1.5	50	4.5	8	-	3500.36.32	10
Pg 36	M40x1.5	50	4.5	8	-	3500.36.40	10
Pg 42	M32x1.5	55	5.0	10	-	3500.42.32	10
Pg 42	M40x1.5	55	5.0	10	-	3500.42.40	10
Pg 42	M50x1.5	55	15.0	10	-	3500.42.50	10
Pg 48	M40x1.5	65	5.5	11	-	3500.48.40	5
Pg 48	M50x1.5	65	5.5	11	-	3500.48.50	5

1 = Metrisches Regelgewinde

1 = Metric coarse-pitch thread

Adapter Messing Adapter nickel-plated brass

mit 6-kant | hexagonal

Material: Messing vernickelt
O-Ring : NBR
Einsatztemperatur: -40°C / +100°C
Schutzart: IP 68

Material: Nickel-plated brass
O-ring : NBR
Temperature range: -40°C / +100°C
Protection class: IP 68

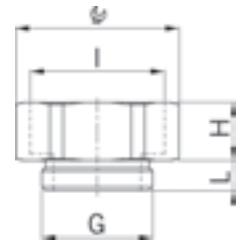

Aussengewinde Pg
Innengewinde metrisch
mit O-Ring

Outer thread Pg
Inner thread metric
with O-ring

G	I	IG	H mm	L mm	Art.-Nr. Art. No.	
Pg 7	M12x1.5	15	9.0	6	3600.07.12	50
Pg 7	M16x1.5	18	9.0	6	3600.07.17	50
Pg 9	M16x1.5	18	9.5	6	3600.09.17	50
Pg 9	M20x1.5	24	10.5	6	3600.09.20	50
Pg 11	M20x1.5	24	10.5	6	3600.11.20	50
Pg 11	M25x1.5	30	11.5	6	3600.11.25	25
Pg 13	M20x1.5	24	10.5	6	3600.13.20	50
Pg 13	M25x1.5	30	11.5	6	3600.13.25	25
Pg 16	M25x1.5	30	11.5	6	3600.16.25	25
Pg 16	M32x1.5	36	13.5	6	3600.16.32	25
Pg 21	M32x1.5	36	14.0	7.5	3600.21.32	25
Pg 21	M40x1.5	46	14.0	7.5	3600.21.40	20
Pg 29	M40x1.5	46	14.0	8	3600.29.40	20
Pg 29	M50x1.5	55	16.0	8	3600.29.50	10
Pg 36	M50x1.5	55	16.0	8	3600.36.50	10
Pg 36	M63x1.5	70	17.0	8	3600.36.63	10
Pg 42	M63x1.5	70	17.0	10	3600.42.63	10
Pg 42	M75x1.5	80	18.0	10	3600.42.75	10
Pg 48	M63x1.5	70	17.0	11	3600.48.63	10
Pg 48	M75x1.5	80	18.0	11	3600.48.75	10

Runde Bauform, randriert | Round, knurled

Material: Messing vernickelt
Einsatztemperatur: -40°C / +200°C
Schutzart: IP 54
Weitere Schutzart: IP 68, wenn Anschluss-
gewinde abgedichtet

Material: Nickel-plated brass
Temperature range: -40°C / +200°C
Protection class: IP 54
Further protection: IP 68, if the entry thread
is sealed

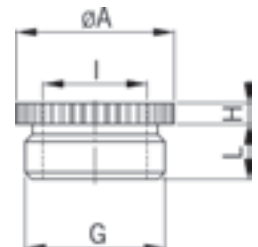

Aussengewinde Pg
Innengewinde metrisch
ohne O-Ring

Outer thread Pg
Inner thread metric
without O-Ring

G	I	ØA mm	H mm	L mm	Art.-Nr. Art. No.	
Pg 11	M16x1.5	20	10	6	3545.11.17	50
Pg 16	M20x1.5	24	11	6	3545.16.20	50
Pg 21	M20x1.5	30	3.5	7.5	3545.21.20	50
Pg 21	M25x1.5	30	11	7.5	3545.21.25	50
Pg 29	M25x1.5	39	4	8	3545.29.25	25
Pg 29	M32x1.5	39	4	8	3545.29.32	25
Pg 36	M40x1.5	50	4.5	8	3545.36.40	10

Adapter Messing

Adapter nickel-plated brass

Runde Bauform | Round execution

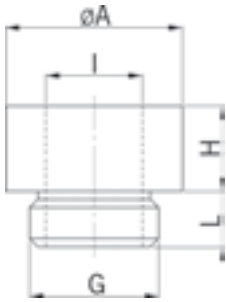

Material: Messing vernickelt
 Einsatztemperatur: -40°C / +200°C
 Schutzart: IP 54
 Weitere Schutzart: IP 68, wenn Anschluss-
 gewinde abgedichtet

Material: Nickel-plated brass
 Temperature range: -40°C / +200°C
 Protection class: IP 54
 Further protection: IP 68, if the entry thread
 is sealed



Aussengewinde Pg
 Innengewinde metrisch
 ohne O-Ring

Outer thread Pg
 Inner thread metric
 without O-Ring

G	I	øA mm	H mm	L mm	Art.-Nr. Art. No.	
Pg 7	M12x1.5	14	9	6	3645.07.12	100
Pg 9	M16x1.5	19	9.5	6	3645.09.17	50
Pg 11	M20x1.5	22	11	6	3645.11.20	50
Pg 13	M20x1.5	22	11	6	3645.13.20	50
Pg 16	M25x1.5	27	11	6	3645.16.25	50
Pg 21	M32x1.5	34	12	7.5	3645.21.32	50
Pg 29	M40x1.5	42	12	8	3645.29.40	10

mit 6-kant | hexagonal

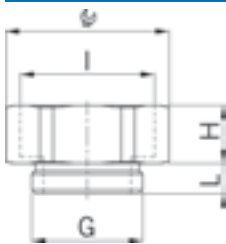

Material: Messing vernickelt
 O-Ring : NBR
 Einsatztemperatur: -40°C / +100°C
 Schutzart: IP 68

Material: Nickel-plated brass
 O-ring : NBR
 Temperature range: -40°C / +100°C
 Protection class: IP 68



Aussengewinde Pg
 Innengewinde Gasrohr
 mit O-Ring

Outer thread Pg
 Inner thread gas-pipe
 with O-ring

G	I	øA mm	H mm	L mm	Art.-Nr. Art. No.	
Pg 13	G3/8"	24	3	7	35133/8G	50
Pg 16	G1/2"	24	14	10	36161/2G.08	50
Pg 21	G3/4"	32	14	12	36213/4G.08	25
Pg 36	G 2"	64	20	12	3636.48.08	10
Pg 42	G 2"	64	20	15	3642.48.08	10



Aussengewinde Gasrohr
 Innengewinde Pg
 mit O-Ring

Outer thread gas-pipe
 Inner thread Pg
 with O-ring

G	I	øA mm	H mm	L mm	Art.-Nr. Art. No.	
G3/8"	Pg 7	20	3	10	353/8G.07	50
G1/2"	Pg 9	24	3	9.5	351/2G.09	50
G3/4"	Pg 9	30	3.5	11	353/4G.09	50
G3/4"	Pg 11	30	3.5	11	353/4G.11	50
G3/4"	Pg 16	32	3.5	11	353/4G.16	50
G 1"	Pg 21	38	3.5	11	351G.21	25
G 1 1/4"	Pg 29	50	5	11	3511/4G.29	25
G 2"	Pg 36	64	5	11	352G.36	10
G 2"	Pg 42	64	5	11	352G.42	10

Adapter Messing Adapter nickel-plated brass

mit 6-kant | hexagonal

Material: Messing vernickelt
O-Ring : NBR
Einsatztemperatur: -40°C / +100°C
Schutzart: IP 68

Material: Nickel-plated brass
O-ring : NBR
Temperature range: -40°C / +100°C
Protection class: IP 68

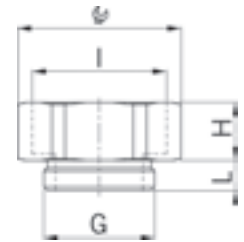

Aussengewinde Gasrohr
Gewinde innen Pg
mit O-Ring

Outer thread gas-pipe
Inner thread Pg
with O-ring

G	I	IG	H mm	L mm	Art.-Nr. Art. No.	
G3/8"	Pg 11	20	12	10	363/8G.11.08	50
G1/2"	Pg 11	24	12	10	361/2G.11.08	50
G1/2"	Pg 13	24	12	10	361/2G.13.08	50
G1/2"	Pg 16	24	12	10	361/2G.16.08	50
G5/8"	Pg 16	24	12	10	365/8G.16.08	50
G3/4"	Pg 21	32	15	12	363/4G.21.08	25
G7/8"	Pg 29	41	15	12	367/8G.29.08	25
G 1"	Pg 29	41	15	11	361G.29.08	25
G 1 1/2"	Pg 36	54	22	12	3611/2G.36.08	10

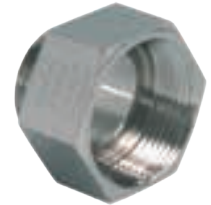

mit 6-kant | hexagonal

Material: Messing vernickelt
Einsatztemperatur: -40°C / +100°C
Schutzart: IP 68, wenn Anschluss-
gewinde abgedichtet

Material: Nickel-plated brass
Temperature range: -40°C / +100°C
Protection class: IP 68, if the entry thread
is sealed

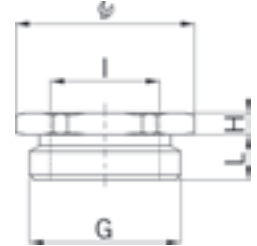

Aussengewinde NPT
Innengewinde Pg
ohne O-Ring

Outer thread NPT
Inner thread Pg
without O-Ring

G	I	IG	H mm	L mm	Art.-Nr. Art. No.	
NPT1/2"	Pg 9	22	4.5	20	351/2NPT.09	50
NPT3/4"	Pg 11	30	4	20	353/4NPT.11	10
NPT3/4"	Pg 13	30	4	20	353/4NPT.13	10
NPT 1"	Pg 16	36	6	26	351NPT.16	10



mit 6-kant | hexagonal

Material: Messing vernickelt
O-Ring : NBR
Einsatztemperatur: -40°C / +100°C
Schutzart: IP 68, wenn Anschluss-
gewinde abgedichtet

Material: Nickel-plated brass
O-ring : NBR
Temperature range: -40°C / +100°C
Protection class: IP 68, if the entry thread
is sealed

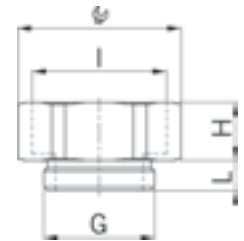

Aussengewinde NPT
Innengewinde Pg
ohne O-Ring

Outer thread NPT
Inner thread Pg
without O-Ring

G	I	IG	H mm	L mm	Art.-Nr. Art. No.	
NPT1/2"	Pg 11	24	12	20	361/2NPT.11	50
NPT1/2"	Pg 13	24	14	20	361/2NPT.13	50
NPT1/2"	Pg 16	34	20	20	361/2NPT.16	50
NPT3/4"	Pg 21	32	14	20	363/4NPT.21	25



Reduktionen und Erweiterungen Kunststoff

Synthetic reduction and enlarging fittings

mit 6-kant | hexagonal

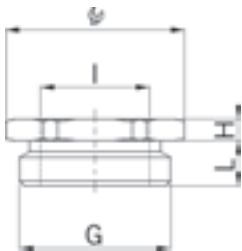

Reduktionen Kunststoff

Material: Polyamid PA 6
 Eigenschaften: halogenfrei
 Einsatztemperatur: -30°C / +100°C
 Schutzart: IP 54
 Weitere Schutzart: IP 68, wenn Anschluss-
 gewinde abgedichtet

Synthetic reduction fittings

Material: Polyamide PA 6
 Properties: Halogen-free
 Temperature range: -30°C / +100°C
 Protection class: IP 54
 Further protection: IP 68, if the entry thread
 is sealed



Aussengewinde metrisch
 Innengewinde metrisch
 Hellgrau RAL 7035

Outer thread metric
 Inner thread metric
 Light grey RAL 7035

G	I		H mm	L mm	Art.-Nr. Art. No.	
M16x1.5	M12x1.5	22	4	8	3455.17.12	100
M20x1.5	M12x1.5	24	4	8	3455.20.12	100
M20x1.5	M16x1.5	24	4	8	3455.20.17	100
M25x1.5	M12x1.5	29	6	8	3455.25.12	100
M25x1.5	M16x1.5	29	6	8	3455.25.17	100
M25x1.5	M20x1.5	29	6	8	3455.25.20	100
M32x1.5	M12x1.5	36	6	10	3455.32.12	50
M32x1.5	M16x1.5	36	6	10	3455.32.17	50
M32x1.5	M20x1.5	36	6	10	3455.32.20	50
M32x1.5	M25x1.5	36	6	10	3455.32.25	50
M40x1.5	M16x1.5	46	6	10	3455.40.17	50
M40x1.5	M20x1.5	46	6	10	3455.40.20	50
M40x1.5	M25x1.5	46	6	10	3455.40.25	25
M40x1.5	M32x1.5	46	6	10	3455.40.32	25
M50x1.5	M20x1.5	55	6	12	3455.50.20	5
M50x1.5	M25x1.5	55	6	12	3455.50.25	5
M50x1.5	M32x1.5	55	6	12	3455.50.32	5
M50x1.5	M40x1.5	55	6	12	3455.50.40	5
M63x1.5	M25x1.5	68	6	12	3455.63.25	5
M63x1.5	M32x1.5	68	6	12	3455.63.32	5
M63x1.5	M40x1.5	68	6	12	3455.63.40	5
M63x1.5	M50x1.5	68	6	12	3455.63.50	5

mit 6-kant | hexagonal

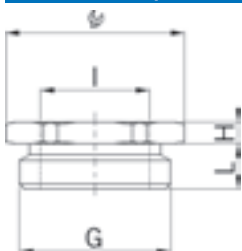

Reduktionen Kunststoff

Material: Polyamid glasfaserver-
 stärkt
 Einsatztemperatur: -20°C / +100°C
 Schutzart: IP 54
 Weitere Schutzart: IP 68, wenn Anschluss-
 gewinde abgedichtet

Synthetic reduction fittings

Material: Polyamide glass fiber
 reinforced
 Temperature range: -20°C / +100°C
 Protection class: IP 54
 Further protection: IP 68, if the entry thread
 is sealed



Aussengewinde Pg
 Innengewinde Pg
 Hellgrau

Outer thread Pg
 Inner thread Pg
 Light grey

G	I		H mm	L mm	Art.-Nr. Art. No.	
Pg 9	Pg 7	19	12	8	3409.07	50
Pg 11	Pg 7	22	3	8	3411.07	50
Pg 11	Pg 9	22	15	8	3411.09	50
Pg 13	Pg 9	24	3	9	3413.09	50
Pg 13	Pg 11	24	15	9	3413.11	50
Pg 16	Pg 9	27	5	9	3416.09	50
Pg 16	Pg 11	27	5	9	3416.11	50
Pg 16	Pg 13	27	17	10	3416.13	50
Pg 21	Pg 13	32	5	11	3421.13	25
Pg 21	Pg 16	32	5	11	3421.16	25
Pg 29	Pg 21	41	6	12	3429.21	10
Pg 36	Pg 29	50	6	14	3436.29	10

rund mit 6-kant | round with hexagon

Erweiterungen Kunststoff

Material: Polyamid PA 6
 Eigenschaften: halogenfrei
 Einsatztemperatur: -30°C / +100°C
 Schutzart: IP 54
 Weitere Schutzart: IP 68, wenn Anschluss-
 gewinde abgedichtet

Synthetic enlarging fittings

Material: Polyamide PA 6
 Properties: Halogen-free
 Temperature range: -30°C / +100°C
 Protection class: IP 54
 Further protection: IP 68, if the entry thread
 is sealed

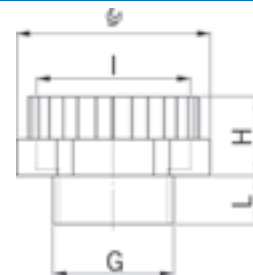

Aussengewinde metrisch
 Innengewinde metrisch
 Hellgrau RAL 7035

Outer thread metric
 Inner thread metric
 Light grey RAL 7035

G	I		H mm	L mm	Art.-Nr. Art. No.	
M12x1.5	M16x1.5	20	13	8	3755.12.17	100
M16x1.5	M20x1.5	24	13	8	3755.17.20	100
M20x1.5	M25x1.5	29	13	8	3755.20.25	100
M25x1.5	M32x1.5	36	15	8	3755.25.32	50
M32x1.5	M40x1.5	46	15	10	3755.32.40	25
M40x1.5	M50x1.5	55	15	10	3755.40.50	10
M50x1.5	M63x1.5	68	15	10	3755.50.63	10



rund mit 6-kant | round with hexagon

Erweiterungen Kunststoff

Material: Polyamid glasfaserver-
 stärkt
 Einsatztemperatur: -20°C / +100°C
 Schutzart: IP 54, IP 68 wenn
 Anschlussgewinde abge-
 dichtet

Synthetic enlarging fittings

Material: Polyamide glass fiber
 reinforced
 Temperature range: -20°C / +100°C
 Protection class: IP 54, IP 68 if the thread
 is sealed



Aussengewinde Pg
 Innengewinde Pg
 Hellgrau

Outer thread Pg
 Inner thread Pg
 Light grey

G	I		H mm	L mm	Art.-Nr. Art. No.	
Pg 7	Pg 9	19	18	7	3707.09	50
Pg 9	Pg 11	22	19	7	3709.11	50
Pg 11	Pg 13	24	21	8	3711.13	50
Pg 13	Pg 16	27	23	9	3713.16	50
Pg 16	Pg 21	32	26	9	3716.21	25
Pg 21	Pg 29	41	33	10	3721.29	25
Pg 29	Pg 36	55	39	12	3729.36	10
Pg 36	Pg 42	60	46	14	3736.42	10
Pg 42	Pg 48	65	39	16	3742.48	10



Adapter Kunststoff

Synthetic adapter

rund mit 6-kant | round with hexagon

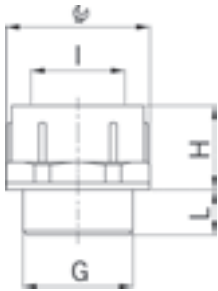

Material: Polyamid glasfaserverstärkt
 Einsatztemperatur: -20°C / +100°C
 Schutzart: IP 54
 Weitere Schutzart: IP 68, wenn Anschlussgewinde abgedichtet

Material: Polyamide glass fiber reinforced
 Temperature range: -20°C / +100°C
 Protection class: IP 54
 Further protection: IP 68, if the entry thread is sealed



Aussengewinde metrisch
 Innengewinde Pg
 Hellgrau

Outer thread metric
 Inner thread Pg
 Light grey

G	I	$\frac{G}{Pg}$	H mm	L mm	Art.-Nr. Art. No.	
M12x1.5	Pg 9	19	13	11	3712.09	50
M20x1.5	Pg 13	24	15	11	3720.13	50
M20x1.5	Pg 16	27	17	11	3720.16	50
M25x1.5	Pg 21	33	20	11	3725.21	25
M32x1.5	Pg 29	42	22	11	3732.29	25
M50x1.5	Pg 42	60	28	11	3750.42	10

mit 6-kant | hexagonal



Aussengewinde metrisch
 Gewinde innen Pg
 Hellgrau

Outer thread metric
 Inner thread Pg
 Light grey

G	I	$\frac{G}{Pg}$	H mm	L mm	Art.-Nr. Art. No.	
M16x1.5	Pg 9	19	14	11	3417.09	50
M20x1.5	Pg 11	22	16	11	3420.11	50
M25x1.5	Pg 16	27	18	11	3425.16	50
M40x1.5	Pg 29	42	23	11	3440.29	25
M50x1.5	Pg 36	53	26	11	3450.36	10
M63x1.5	Pg 48	65	29	11	3463.48	5

rund mit 6-kant | round with hexagon

Material: Polyamid PA 6
 Eigenschaften: halogenfrei
 Einsatztemperatur: -30°C / +100°C
 Schutzart: IP 54
 Weitere Schutzart: IP 68, wenn Anschluss-
 gewinde abgedichtet

Material: Polyamide PA 6
 Properties: Halogen-free
 Temperature range: -30°C / +100°C
 Protection class: IP 54
 Further protection: IP 68, if the entry thread
 is sealed

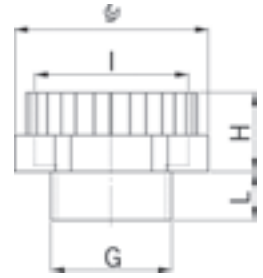

Aussengewinde Pg
 Innengewinde metrisch
 Hellgrau RAL 7035

Outer thread Pg
 Inner thread metric
 Light grey RAL 7035

G	I		H mm	L mm	Art.-Nr. Art. No.	
Pg 7	M12x1.5	15	12	8	3755.07.12	100
Pg 7	M16x1.5	20	12	8	3755.07.17	100
Pg 9	M16x1.5	20	12	8	3755.09.17	100
Pg 9	M20x1.5	24	12	8	3755.09.20	100
Pg 11	M20x1.5	24	12	8	3755.11.20	100
Pg 13	M25x1.5	30	13	9	3755.13.25	100
Pg 16	M25x1.5	30	13	10	3755.16.25	50
Pg 21	M32x1.5	37	14	11	3755.21.32	50
Pg 29	M40x1.5	45	14	11	3755.29.40	50
Pg 42	M50x1.5	55	17	11	3755.42.50	10
Pg 48	M63x1.5	68	17	11	3755.48.63	5



Aussengewinde Pg
 Innengewinde metrisch
 Hellgrau RAL 7035

Outer thread Pg
 Inner thread metric
 Light grey RAL 7035

G	I		H mm	L mm	Art.-Nr. Art. No.	
Pg 9	M12x1.5	19	12	8	3455.09.12	100
Pg 11	M16x1.5	22	12	8	3455.11.17	100
Pg 13	M16x1.5	24	13	9	3455.13.17	100
Pg 13	M20x1.5	24	13	9	3455.13.20	100
Pg 16	M20x1.5	27	13	10	3455.16.20	50
Pg 21	M25x1.5	33	14	11	3455.21.25	50
Pg 29	M32x1.5	42	14	11	3455.29.32	50
Pg 36	M40x1.5	55	14	11	3455.36.40	25



1
2
3
4
5
6
7
8
9
10
11
12

Verschlusschrauben Messing

Locking plugs nickel-plated brass

Kurzes Anschlussgewinde metrisch | Short entry thread metric

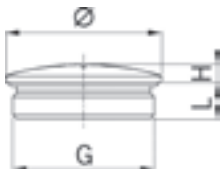

Verschlusschraube Messing

Material: Messing vernickelt
 O-Ring : NBR
 Einsatztemperatur: -40°C / +100°C
 Schutzart: IP 68

Locking plug nickel-plated brass

Material: Nickel-plated brass
 O-ring : NBR
 Temperature range: -40°C / +100°C
 Protection class: IP 68



Runde Bauform
mit O-Ring

Round execution
with O-ring

G	Ø mm	H mm	L mm	i info	Art.-Nr. Art. No.	
M6x1.0	9	3	5	1	8706.08	50
M8x1.25	10	3	5	1	8708.08	50
M10x1.5	12	3	5	1	8710.08	50
M12x1.5	14	3	5	-	8712.08	50
M16x1.5	19	3	5	-	8717.08	50
M20x1.5	24	3	6	-	8720.08	25
M25x1.5	28	4	7	-	8725.08	25
M32x1.5	35	4	8	-	8732.08	10
M40x1.5	45	6	8	-	8740.08	10
M50x1.5	55	6	9	-	8750.08	10
M63x1.5	70	6	10	-	8763.08	10
M75x1.5	80	6	11	-	8775.08	5

1 = Metrisches Regelgewinde

1 = Metric coarse-pitch thread

Langes Anschlussgewinde metrisch | Long entry thread metric



Runde Bauform
mit O-Ring

Round execution
with O-ring

G	Ø mm	H mm	L mm	i info	Art.-Nr. Art. No.	
M6x1.0	9	3	8	1	8706.11.08	50
M8x1.25	10	3	10	1	8708.11.08	50
M10x1.5	12	3	10	1	8710.11.08	50
M12x1.5	14	3	10	-	8712.11.08	50
M16x1.5	19	3	10	-	8717.11.08	50
M20x1.5	24	3	10	-	8720.11.08	25
M25x1.5	28	4	11	-	8725.11.08	25
M32x1.5	35	4	13	-	8732.11.08	10
M40x1.5	45	6	13	-	8740.11.08	10
M50x1.5	55	6	14	-	8750.11.08	10
M63x1.5	70	6	15	-	8763.11.08	10
M75x1.5	80	6	15	-	8775.11.08	5

1 = Metrisches Regelgewinde

1 = Metric coarse-pitch thread



Verschlusschrauben Messing

Locking plugs nickel-plated brass

Kurzes Anschlussgewinde metrisch | Short entry thread metric

Verschlusschraube Messing

Material: Messing vernickelt
 Einsatztemperatur: -40°C / +200°C
 Schutzart: IP 54
 Weitere Schutzart: IP 68, wenn Anschluss-
 gewinde abgedichtet

Locking plug nickel-plated brass

Material: Nickel-plated brass
 Temperature range: -40°C / +200°C
 Protection class: IP 54
 Further protection: IP 68, if the entry thread
 is sealed

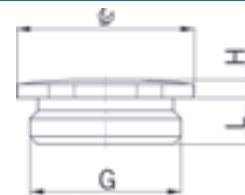

6-kant
 ohne O-Ring

Hexagonal design
 without O-Ring

G		H mm	L mm	Art.-Nr. Art. No.	
M12x1.5	14	2.5	5	8745.12	100
M16x1.5	18	2.5	5	8745.17	100
M20x1.5	22	2.5	6	8745.20	100
M25x1.5	27	3.0	7	8745.25	50
M32x1.5	34	3.5	8	8745.32	25
M40x1.5	42	4.0	8	8745.40	25
M50x1.5	52	4.0	9	8745.50	10
M63x1.5	65	4.0	10	8745.63	10



Kurzes Anschlussgewinde Pg | Short entry thread Pg

Verschlusschraube Messing

Material: Messing vernickelt
 O-Ring : NBR
 Einsatztemperatur: -40°C / +100°C
 Schutzart: IP 68

Locking plug nickel-plated brass

Material: Nickel-plated brass
 O-ring : NBR
 Temperature range: -40°C / +100°C
 Protection class: IP 68

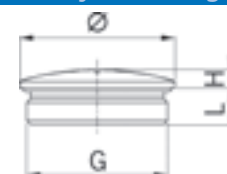

Runde Bauform
 mit O-Ring

Round execution
 with O-ring

G	Ø mm	H mm	L mm	Art.-Nr. Art. No.	
Pg 7	14	3	5	8707.08	100
Pg 9	17	3	6	8709.08	100
Pg 11	20	3	6	8711.08	100
Pg 13	22	3	6.5	8713.08	50
Pg 16	24	3	6.5	8716.08	50
Pg 21	30	4	7	8721.08	10
Pg 29	39	4	8	8729.08	10
Pg 36	50	6	9	8736.08	10
Pg 42	60	6	10	8742.08	10
Pg 48	65	6	10	8748.48.08	10
G 2"	65	6	10	8748.08	10



Langes Anschlussgewinde Pg | Long entry thread Pg

Runde Bauform
 mit O-Ring

Round execution
 with O-ring

G	Ø mm	H mm	L mm	Art.-Nr. Art. No.	
Pg 7	14	3	10	8707.11.08	100
Pg 9	17	3	10	8709.11.08	100
Pg 11	20	3	10	8711.11.08	100
Pg 13	22	3	10	8713.11.08	50
Pg 16	24	3	10	8716.11.08	50
Pg 21	30	4	12	8721.11.08	10
Pg 29	39	4	12	8729.11.08	10
Pg 36	50	6	15	8736.11.08	10
G 2"	65	6	15	8748.11.08	10



Verschlusschrauben rostfreier Stahl A2

Locking plugs stainless steel A2

Runde Bauform | Round execution

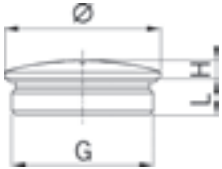

Material: Rostfreier CrNi-Stahl A2 (DIN EN 1.4305 / AISI 303)
 O-Ring : NBR
 Einsatztemperatur: -40°C / +100°C
 Schutzart: IP 68

Material: CrNi stainless steel A2 (DIN EN 1.4305 / AISI 303)
 O-ring : NBR
 Temperature range: -40°C / +100°C
 Protection class: IP 68



Kurzes Anschlussgewinde metrisch mit O-Ring

Short entry thread metric with O-ring

G	Ø mm	H mm	L mm	i info	Art.-Nr. Art. No.	
M10x1.5	12	3	5	1	8710.96.08.70	50
M12x1.5	14	3	5	-	8712.96.08.70	50
M16x1.5	19	3	5	-	8717.96.08.70	50
M20x1.5	24	3	6	-	8720.96.08.70	25
M25x1.5	28	4	7	-	8725.96.08.70	25
M32x1.5	35	4	8	-	8732.96.08.70	10
M40x1.5	45	6	8	-	8740.96.08.70	10
M50x1.5	55	6	9	-	8750.96.08.70	10
M63x1.5	70	6	10	-	8763.96.08.70	10
M75x1.5	80	6	11	-	8775.96.08.70	5

1 = Metrisches Regelgewinde

1 = Metric coarse-pitch thread

Auf Anfrage lieferbar:

Available on request:

Anschlussgewinde Pg

Entry thread Pg



Langes Anschlussgewinde metrisch mit O-Ring

Long entry thread metric with O-ring

G	Ø mm	H mm	L mm	i info	Art.-Nr. Art. No.	
M10x1.5	12	3	10	1	8710.96.11.08.70	50
M12x1.5	14	3	10	-	8712.96.11.08.70	50
M16x1.5	19	3	10	-	8717.96.11.08.70	50
M20x1.5	24	3	10	-	8720.96.11.08.70	25
M25x1.5	28	4	11	-	8725.96.11.08.70	25
M32x1.5	35	4	13	-	8732.96.11.08.70	10
M40x1.5	45	6	13	-	8740.96.11.08.70	10
M50x1.5	55	6	14	-	8750.96.11.08.70	10
M63x1.5	70	6	15	-	8763.96.11.08.70	10
M75x1.5	80	6	15	-	8775.96.11.08.70	5

1 = Metrisches Regelgewinde

1 = Metric coarse-pitch thread

Auf Anfrage lieferbar:

Available on request:

Anschlussgewinde Pg

Entry thread Pg

Verschlusschrauben rostfreier Stahl A2 für hohe Temperaturen

Locking plugs stainless steel A2 for high temperature applications

Material: Rostfreier CrNi-Stahl A2 (DIN EN 1.4305 / AISI 303)
 O-Ring : FPM
 Einsatztemperatur: -40°C / +200°C
 Schutzart: IP 68

Material: CrNi stainless steel A2 (DIN EN 1.4305 / AISI 303)
 O-ring : FPM
 Temperature range: -40°C / +200°C
 Protection class: IP 68

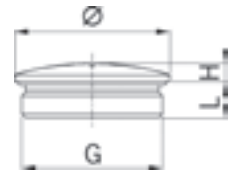

Kurzes Anschlussgewinde metrisch mit O-Ring

Short entry thread metric with O-ring

G	Ø mm	H mm	L mm	i info	Art.-Nr. Art. No.	
M10x1.5	12	3	5	1	8710.96.08	50
M12x1.5	14	3	5	-	8712.96.08	50
M16x1.5	19	3	5	-	8717.96.08	50
M20x1.5	24	3	6	-	8720.96.08	25
M25x1.5	28	4	7	-	8725.96.08	25
M32x1.5	35	4	8	-	8732.96.08	10
M40x1.5	45	6	8	-	8740.96.08	10
M50x1.5	55	6	9	-	8750.96.08	10
M63x1.5	70	6	10	-	8763.96.08	10
M75x1.5	80	6	11	-	8775.96.08	5

1 = Metrisches Regelgewinde

1 = Metric coarse-pitch thread

Auf Anfrage lieferbar:

Available on request:

Anschlussgewinde Pg

Entry thread Pg



Langes Anschlussgewinde metrisch mit O-Ring

Long entry thread metric with O-ring

G	Ø mm	H mm	L mm	i info	Art.-Nr. Art. No.	
M10x1.5	12	3	10	1	8710.96.11.08	50
M12x1.5	14	3	10	-	8712.96.11.08	50
M16x1.5	19	3	10	-	8717.96.11.08	50
M20x1.5	24	3	10	-	8720.96.11.08	25
M25x1.5	28	4	11	-	8725.96.11.08	25
M32x1.5	35	4	13	-	8732.96.11.08	10
M40x1.5	45	6	13	-	8740.96.11.08	10
M50x1.5	55	6	14	-	8750.96.11.08	10
M63x1.5	70	6	15	-	8763.96.11.08	10
M75x1.5	80	6	15	-	8775.96.11.08	5

1 = Metrisches Regelgewinde

1 = Metric coarse-pitch thread

Auf Anfrage lieferbar:

Available on request:

Anschlussgewinde Pg

Entry thread Pg



1
2
3
4
5
6
7
8
9
10
11
12

Verschlusschrauben Kunststoff

Synthetic locking plugs

Gewinde metrisch | Metric thread

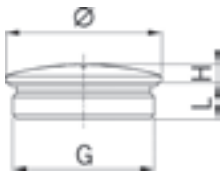

Verschlusschraube Kunststoff

Material: Polyamid PA 6
 Einsatztemperatur: -30°C / +100°C
 Schutzart: IP 54
 Weitere Schutzart: IP 68, wenn Anschluss-
 gewinde abgedichtet

Synthetic locking plug

Material: Polyamide PA 6
 Temperature range: -30°C / +100°C
 Protection class: IP 54
 Further protection: IP 68, if the entry thread
 is sealed



Hellgrau RAL 7035
 ohne O-Ring

Light grey RAL 7035
 without O-Ring

G	Ø mm	H mm	L mm	Art.-Nr. Art. No.	
M12x1.5	15	4.5	6	8855.12	100
M16x1.5	20	4.5	6	8855.17	100
M20x1.5	24	4.5	6	8855.20	100
M25x1.5	30	5.0	8	8855.25	100
M32x1.5	37	5.5	8	8855.32	50
M40x1.5	46	6.0	8	8855.40	50
M50x1.5	56	6.0	10	8855.50	10
M63x1.5	70	6.0	12	8855.63	10



Schwarz RAL 9005
 ohne O-Ring

Black RAL 9005
 without O-Ring

G	Ø mm	H mm	L mm	Art.-Nr. Art. No.	
M12x1.5	15	4.5	6	8845.12	100
M16x1.5	20	4.5	6	8845.17	100
M20x1.5	24	4.5	6	8845.20	100
M25x1.5	30	5.0	8	8845.25	100
M32x1.5	37	5.5	8	8845.32	50
M40x1.5	46	6.0	8	8845.40	50
M50x1.5	56	6.0	10	8845.50	10
M63x1.5	70	6.0	12	8845.63	10

Anschlussgewinde Pg | Entry thread Pg

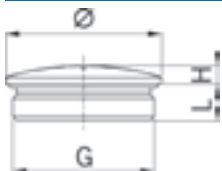

Verschlusschraube Kunststoff

Material: Polystyrol schlagfest
 Einsatztemperatur: -20°C / +80°C
 Schutzart: IP 54, IP 68 wenn
 Anschlussgewinde abge-
 dichtet

Synthetic locking plug

Material: Shock-resistant polysty-
 rene
 Temperature range: -20°C / +80°C
 Protection class: IP 54, IP 68 if the thread
 is sealed



Hellgrau RAL 7035
 ohne O-Ring

Light grey RAL 7035
 without O-Ring

G	Ø mm	H mm	L mm	Art.-Nr. Art. No.	
Pg 7	15	2.0	6.0	8807	100
Pg 9	19	3.0	6.5	8809	100
Pg 11	22	3.5	6.5	8811	100
Pg 13	25	3.5	6.5	8813	100
Pg 16	27	3.5	6.5	8816	100
Pg 21	33	4.0	8.0	8821	100
Pg 29	44	4.0	8.0	8829	50
Pg 36	55	4.0	10.0	8836	25
Pg 42	62	4.0	10.0	8842	10
Pg 48	69	4.0	12.0	8848.48	25



passend zu Kabelverschraubungen Progress® | suitable for cable glands Progress®

Material: NBR
Einsatztemperatur: -40°C / +100°C

Material: NBR
Temperature range: -40°C / +100°C

Kurzer Dichteinsatz ohne Bohrung

Short sealing insert without drilled hole

G	 mm	Art.-Nr. Art. No.	
M6	3.5	1000.06.30.03	1
M8	5.0	1000.08.30.03	1
M10	6.0	1000.10.30.03	1
Pg 11	12.0	1000.11.30.03	1
M12 / Pg 7	8.0	1000.12.30.03	1
M16 / Pg 9	10.5	1000.17.30.03	1
M20 / Pg 13 / Pg 16	15.0	1000.20.30.03	1
M25 / Pg 21	20.5	1000.25.30.03	1
Pg 29	27.5	1000.29.30.03	1
M32	25.5	1000.32.30.03	1
Pg 36	35.0	1000.36.30.03	1
M40	33.0	1000.40.30.03	1
Pg 48	49.0	1000.48.30.03	1
M50 / Pg 42	42.0	1000.50.30.03	1
M63	52.0	1000.63.30.03	1
M75	63.0	1000.75.30.03	1
M85	70.0	1000.085.30.03	1
M95	80.0	1000.095.30.03	1
M100	85.0	1000.100.30.03	1
M105	90.0	1000.105.30.03	1
M115	95.0	1000.115.30.03	1



Technischer Hinweis

Dichteinsätze ohne Bohrung lassen sich gut bearbeiten, wenn sie vorher auf mindestens -25°C gefroren wurden.

Technical note

When frozen to at least -25°C, the solid sealing inserts are easy to drill.

passend zu Kabelverschraubungen Progress® | suitable for cable glands Progress®

Dichteinsätze Vollgummi für hohe Temperaturen

Solid rubber sealing inserts for high-temperatures applications

Material: FPM
Einsatztemperatur: -40°C / +200°C

Material: FPM
Temperature range: -40°C / +200°C

Kurzer Dichteinsatz ohne Bohrung

Short sealing insert without drilled hole

G	 mm	Art.-Nr. Art. No.	
M6	3.5	1000.06.98.30.03	1
M8	5.0	1000.08.98.30.03	1
M10	6.0	1000.10.98.30.03	1
Pg 11	12.0	1000.11.98.30.03	1
M12 / Pg 7	8.0	1000.12.98.30.03	1
M16 / Pg 9	10.5	1000.17.98.30.03	1
M20 / Pg 16	15.0	1000.20.98.30.03	1
M25 / Pg 21	20.5	1000.25.98.30.03	1
Pg 29	27.5	1000.29.98.30.03	1
M32	25.5	1000.32.98.30.03	1
Pg 36	35.0	1000.36.98.30.03	1
M40 / Pg 29	33.0	1000.40.98.30.03	1
Pg 48	49.0	1000.48.98.30.03	1
M50 / Pg 42	42.0	1000.50.98.30.03	1
M63	52.0	1000.63.98.30.03	1



Technischer Hinweis

Dichteinsätze ohne Bohrung lassen sich gut bearbeiten, wenn sie vorher auf mindestens -25°C gefroren wurden.

Technical note

When frozen to at least -25°C, the solid sealing inserts are easy to drill.

O-Ringe und Dichtungsscheiben

O-rings and sealing washers

passend zu Kabelverschraubungen Progress® | suitable for cable glands Progress®

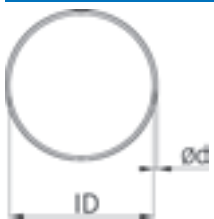

O-Ringe

Material: NBR
Einsatztemperatur: -40°C / +100°C

O-rings

Material: NBR
Temperature range: -40°C / +100°C



zu Anschlussgewinde metrisch oder Pg				suitable for entry thread metric or Pg	
G	G	øl mm	ød mm	Art.-Nr. Art. No.	
M 6	-	5.0	1.0	1005.00.08	1
M 8	-	6.0	1.8	1006.00.08	1
M10	-	8.1	1.6	1006.06.08	1
M12	Pg 7	10.0	1.5	1007.00.08	1
M16	Pg 9	13.1	1.6	1000.09.00.08	1
M20	-	17.0	2.0	2111.00.08	1
M25	-	22.0	2.0	1013.00.22.08	1
M32	-	30.0	2.0	1021.00.30.08	1
M40	-	36.0	2.0	1000.40.00.08	1
M50	-	46.0	2.0	1000.50.00.08	1
M63	-	60.0	2.0	1000.63.00.08	1
M75	-	72.0	2.0	1000.75.00.08	1
-	Pg 11	15.0	2.0	1011.00.08	1
Pg 13	Pg 16	19.0	2.0	1016.00.08	1
-	Pg 21	25.0	2.0	1016.00.25.08	1
-	Pg 29	33.0	2.2	1029.00.08	1
-	Pg 36	42.5	2.6	1036.00.08	1
-	Pg 42	48.0	3.0	1000.42.00.08	1
-	Pg 48	55.0	2.0	1000.48.00.08	1

passend zu Kabelverschraubungen Progress® | suitable for cable glands Progress®

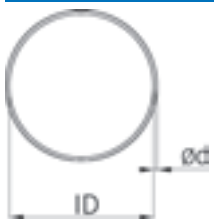

O-Ringe für hohe Temperaturen

Material: FPM
Einsatztemperatur: -40°C / +200°C

O-rings for high temperatures

Material: FPM
Temperature range: -40°C / +200°C



zu Anschlussgewinde metrisch oder Pg				suitable for entry thread metric or Pg	
G	G	øl mm	ød mm	Art.-Nr. Art. No.	
M 6	-	5.0	1.0	1105.98.08	1
M 8	-	6.0	1.8	1106.98.08	1
M10	-	8.1	1.6	1106.06.98.08	1
M12	Pg 7	10.0	1.5	1107.98.08	1
M16	Pg 9	13.1	1.6	1100.09.98.08	1
M20	-	17.0	2.0	2111.98.08	1
M25	-	22.0	2.0	1113.98.22.08	1
M32	-	30.0	2.0	1121.98.30.08	1
M40	-	36.0	2.0	1100.40.98.08	1
M50	-	46.0	2.0	1100.50.98.08	1
M63	-	60.0	2.0	1100.63.98.08	1
M75	-	72.0	2.0	1100.75.98.08	1
-	Pg 11	15.0	2.0	1111.98.08	1
Pg 16	Pg 13	18.0	2.0	1116.98.08	1
-	Pg 21	25.0	2.0	1116.98.25.08	1
-	Pg 29	33.0	1.8	1129.98.08	1
-	Pg 36	42.5	2.6	1136.98.08	1
-	Pg 42	48.0	3.0	1100.42.98.08	1
-	Pg 48	55.0	2.0	1100.48.98.08	1

passend zu Kabelverschraubungen Progress® | suitable for cable glands Progress®

Dichtungsscheiben

Material: KlingerSIL C-4300
Einsatztemperatur: -40°C / +300°C
Farbe: Grün

Sealing washers

Material: KlingerSIL C-4300
Temperature range: -40°C / +300°C
Colour: Green

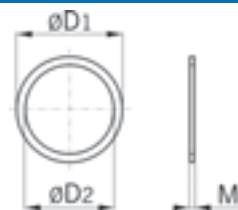

zu Anschlussgewinde metrisch

suitable for metric entry thread

G	ØD1 mm	ØD2 mm	M mm	Art.-Nr. Art. No.	
M6	10.0	6.0	1.5	1006.00.16	1
M8	12.0	8.0	1.5	1008.00.16	1
M10	14.0	10.0	1.5	1010.00.16	1
M12	16.0	12.0	1.5	1012.00.16	1
M16	21.0	16.0	1.5	1017.00.16	1
M20 / Pg 13	25.0	20.5	1.5	1013.00.16	1
M25	31.0	25.0	2.0	1025.00.16	1
M32	39.0	32.0	2.0	1032.00.16	1
M40	48.0	40.0	2.0	1040.00.16	1
M50	59.0	50.0	2.0	1050.00.16	1
M63	73.0	63.0	2.0	1063.00.16	1



zu Anschlussgewinde Pg

suitable for entry thread Pg

G	ØD1 mm	ØD2 mm	M mm	Art.-Nr. Art. No.	
Pg 7	16.5	12.5	1.5	1007.00.16	1
Pg 9	19.0	15.2	1.5	1009.00.16	1
Pg 11	22.5	18.5	1.5	1011.00.16	1
M20 / Pg 13	25.0	20.5	1.5	1013.00.16	1
Pg 16	27.0	22.5	1.5	1016.00.16	1
Pg 21	33.5	28.5	2.0	1021.00.16	1
Pg 29	43.5	37.0	2.0	1029.00.16	1
Pg 36	55.0	47.0	2.0	1036.00.16	1
Pg 42	63.0	54.0	2.0	1042.00.16	1
Pg 48	69.0	59.3	2.0	1048.00.16	1



1
2
3
4
5
6
7
8
9
10
11
12

O-Ringe und Dichtungsscheiben

O-rings and sealing washers

passend zu Kabelverschraubungen Syntec® | suitable for cable glands Syntec®

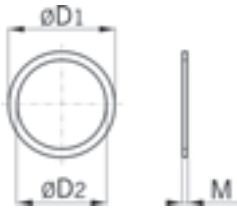

Dichtungsscheiben

Material: Perbunan
Einsatztemperatur: -20°C / +100°C

Sealing washers

Material: Perbunan
Temperature range: -20°C / +100°C



zu Anschlussgewinde metrisch

suitable for metric entry thread

G	ØD1 mm	ØD2 mm	M mm	Art.-Nr. Art. No.	
M12	20	12	1.6	1012.45.16	50
M16	23	16	1.8	1017.45.16	50
M20	29	20	1.8	1020.45.16	50
M25	37	25	1.8	1025.45.16	50
M32	44	32	2.2	1032.45.16	25
M40	52	40	2.2	1040.45.16	25
M50	64	50	2.7	1050.45.16	25
M63	68	63	3.2	1063.45.16	10



zu Anschlussgewinde Pg

suitable for entry thread Pg

G	ØD1 mm	ØD2 mm	M mm	Art.-Nr. Art. No.	
Pg 7	16.0	11.5	2.0	1007.45.16	50
Pg 9	19.0	14.0	2.0	1009.45.16	50
Pg 11	22.5	18.5	2.0	1011.45.16	50
Pg 13	25.0	19.0	2.0	1013.45.16	50
Pg 16	27.0	21.0	2.0	1016.45.16	50
Pg 21	34.0	27.0	2.5	1021.45.16	25
Pg 29	43.0	35.0	2.5	1029.45.16	25
Pg 36	54.0	45.0	2.5	1036.45.16	25

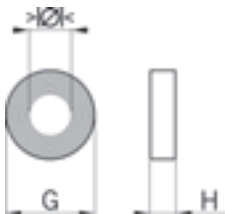

Einschnittringe NBR passend zu Stopfbuchsen B 107- B 263

Material: NBR
Einsatztemperatur: -20°C / +100°C
Einsatzbereich: Passend zu Stopfbuchsen B107 - B263

Sealing rings NBR suitable for cable gland B 107 - B 263

Material: NBR
Temperature range: -20°C / +100°C
Application: Suitable for cable glands series B107 - B263



G	G	>Ø< min mm	>Ø< max mm	H mm	Art.-Nr. Art. No.	
M12	Pg 7	6.0	8.0	5.0	B 107.00.03	50
M16	Pg 9	4.0	11.0	5.5	B 109.00.03	50
-	Pg 11	6.5	12.0	6.0	B 111.00.03	50
-	Pg 13	6.5	13.5	6.0	B 113.00.03	50
M20	Pg 16	6.5	16.0	7.0	B 116.00.03	50
M25	Pg 21	9.0	20.0	8.0	B 121.00.03	50
M32	Pg 29	17.0	28.0	9.5	B 129.00.03	50
M40	Pg 36	23.0	34.0	12.0	B 136.00.03	50
M50	Pg 42	29.0	40.0	14.0	B 142.00.03	10
M63	Pg 48	35.0	46.0	14.0	B 148.00.03	10

Blindscheiben passend zu Kabelverschraubungen

Blind discs suitable for cable glands

Material: Polyamid
 Einsatztemperatur: -20°C / +100°C
 Einsatzbereich: Staubverschluss zu Kabelverschraubungen

Material: Polyamide
 Temperature range: -20°C / +100°C
 Application: Dust stopper for cable glands

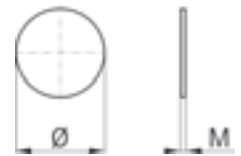

Blindscheibe als Staubschutz

Blind disc for dust protection

G	Ø mm	M mm	Art.-Nr. Art. No.	
M10 / M12 / Pg 7	10.5	0.3	1012.00.19	50
M16 / Pg 9	13.5	0.3	1017.00.19	50
M20 / Pg 11	16.5	0.3	1011.00.19	50
Pg 13 / Pg 16	20.5	0.3	1020.00.19	50
M25 / Pg 21	26.5	0.3	1025.00.19	50
Pg 29	35.0	0.3	1029.00.19	50
M32	30.0	0.3	1032.00.19	50
Pg 36	45.0	0.3	1036.00.19	50
M40	38.0	0.3	1040.00.19	50
M50 / Pg 42	52.0	0.3	1050.00.19	50
M63 / Pg 48	57.0	0.3	1063.00.19	50



Verschlussbolzen aus Kunststoff zu Mehrfach-Kabelverschraubungen

Synthetic locking pins for multi-duct cable glands

Material: Polyamid PA 6
 Einsatztemperatur: -30°C / +100°C
 Einsatzbereich: Zum Verschiessen nicht belegter Bohrungen in Mehrfach-Kabelverschraubungen

Material: Polyamide PA 6
 Temperature range: -30°C / +100°C
 Application: Usable as inserts to close unused holes in sealings of multi-duct cable glands

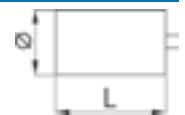

Verschlussbolzen zu Kabelverschraubungen

Locking pins for cable glands

>Ø< mm	L mm	Art.-Nr. Art. No.	
2	12	1310.020.07	50
3	14	1310.030.07	50
4	14	1310.040.07	50
5	14	1310.050.07	50
6	14	1310.060.07	50
7	14	1310.070.07	50
8	14	1310.080.07	50
9	14	1310.090.07	50
10	14	1310.100.07	50
11	14	1310.110.07	50
12	14	1310.120.07	50



1
2
3
4
5
6
7
8
9
10
11
12

Spezialwerkzeug, MontaX® Montageplatte, Montagewinkel, Magnet

Special tool, MontaX® mounting plate, mounting angle, magnet

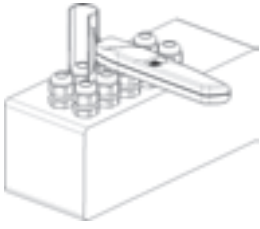

Für Kabelverschraubungen | For cable glands



Spezialwerkzeug für Kabelverschraubungen | Special tool for cable glands

Einsatzbereich:	Montagewerkzeug für Kabelverschraubungen bei engsten Platzverhältnissen	Application:	Assembly tool for cable glands in restricted spaces
Eigenschaften:	Nur 2 Werkzeuge für Schlüsselweiten von 11 bis 36 mm notwendig, Zeitersparnis durch Ratschenfunktion	Properties:	Only 2 tools necessary for wrench sizes from 11 to 36 mm, time-saving due to the ratchet function



verstellbare Schlüsselweiten bei geringem Platzbedarf				adjustable wrench sizes for restricted spaces		Art.-Nr. Art. No.	
 1 mm	 2 mm	L mm	B mm				
11	24	190	60	4800.24		1	
24	36	204	60	4800.36		1	



In Zusammenarbeit mit namhaften Kunden haben wir die Produkteigenschaften erarbeitet, welche für den Anwender besonders wichtig sind und versucht, diese Kriterien zusammen mit Produktionstechnikern in verbesserte Produkte umzusetzen.

Die bemerkenswerteste Änderung ist der spitzere Flechtwinkel, in welchem die Einzelfäden miteinander verwoben sind. Diese neue Flechtweise kombiniert mit einem etwas dünneren Monofil bei der Ausführung in Polyester (0.22 mm im Gegensatz zu 0.25 mm des Vorgängerproduktes) führt zu einem extrem flexiblen Schlauch und zu einer hervorragenden Aufstauchbarkeit. Die Geflechte lassen sich auf das Doppelte ihrer Nennweite aufstauchen.

Der spitzere Flechtwinkel erlaubt ein geschmeidigeres Einführen von Leitungen und Kabeln auch über grössere Längen. Die Einzelfilamente laufen sozusagen parallel zu den Kabeln und stellen sich ihnen nicht als Hindernis oder „Einfädelstelle“ in den Weg.

Sowohl die Polyester- als auch die Polyamid-Geflechschläuche sind nach der neuesten Schienenfahrzeugnorm geprüft (EN 45545-2) und erreichen den Hazard Level 2.

In cooperation with renowned customers, we have defined the product properties which are especially important for the user and have tried together with production technicians to translate these criteria into improved products.

The most notable change is the more pointed braid angle in which the individual threads are interwoven. This new way of braiding, combined with a slightly thinner monofilament in the polyester version (0.22 mm as opposed to the 0.25 mm of the predecessor product) results in an extremely flexible tube and in outstanding tube-fitting qualities. The meshwork can be fitted on to areas twice as large as its nominal width.

The more pointed braid angle permits smoother insertion of cords and cables even across long distances. The individual filaments run virtually parallel to the cables and do not get in their way as an obstruction or "catching area".

Both the polyester and the polyamide braided sleeves have been tested in accordance with the latest rail vehicle standards (EN 45545-2) and can therefore be safely used in this application area.

1
2
3
4
5
6
7
8
9
10
11
12

AGRO Geflechschläuche Kunststoff

AGRO synthetic braided cable sleeving

AGROflex PET Geflechschläuche Polyester

Material:	Polyester PET
Monofil:	Ø 0,22mm
Eigenschaften:	Hochflexibel, selbstanpassend, abriebfest, frei von Cadmium, Formaldehyd, Halogen und Graphit, selbstverlöschend nach DIN 75200 (FMVSS 302), gute Beständigkeit gegen Kraftstoffe, Mineralöle und viele weitere Chemikalien
Einsatztemperatur:	-50°C / +150°C
Aufweitung:	Aufstauchverhältnis 1 : 2

AGROflex PET Braided sleeveings polyester

Material:	Polyester PET
Monofil:	Ø 0,22mm
Properties:	Highly flexible, self-adapting, resistant to abrasion, free of cadmium, formaldehyde, halogen and graphite, self-extinguishing acc. to DIN 75200 (FMVSS 302), good resistance to fuel, mineral oil and many other chemicals
Temperature range:	-50°C / +150°C
Expansion:	Expansion ratio 1 : 2



Polyester PET Schwarz matt				Polyester PET Black matt	
NW	ø min mm	ø max mm	OFB %	Art.-Nr. Art. No.	
3	3	6	86	6875.40.03	200
4	4	8	85	6875.40.04	200
5	3	10	89	6875.40.05	200
8	6	14	81	6875.40.08	150
10	8	20	79	6875.40.10	150
15	13	25	81	6875.40.15	100
20	15	30	77	6875.40.20	100
24	24	38	82	6875.40.24	100
36	34	60	78	6875.40.36	100
50	45	80	82	6875.40.50	50

OFB = Oberflächendeckung OFB = Percentage of the surface covered by fabric



Polyester PET Grau matt				Polyester PET Grey matt	
NW	ø min mm	ø max mm	OFB %	Art.-Nr. Art. No.	
3	3	6	86	6875.70.03	200
4	4	8	85	6875.70.04	200
5	3	10	89	6875.70.05	200
8	6	14	81	6875.70.08	150
10	8	20	79	6875.70.10	150
15	13	25	81	6875.70.15	100
20	15	30	77	6875.70.20	100
24	24	38	82	6875.70.24	100
36	34	60	78	6875.70.36	100
50	45	80	82	6875.70.50	50

OFB = Oberflächendeckung OFB = Percentage of the surface covered by fabric

Spenderbox | Dispenser Box



Schwarz				Black	
NW	ø min mm	ø max mm	i info	Art.-Nr. Art. No.	
5	3	10	12 m	6875.40.05.10	1
10	8	20	12 m	6875.40.10.10	1
18	18	27	6 m	6875.40.18.06	1
30	23	50	6 m	6875.40.30.06	1

AGROflex PA Geflechschläuche Polyamid

AGROflex PA Braided cable sleeveings polyamide

Material: Polyamid PA 6
 Monofil: Ø 0.25mm
 Eigenschaften: Hochflexibel, selbstanpassend, abriebfest, frei von Cadmium, Formaldehyd, Halogen und Graphit, selbstverlöschend nach DIN 75200 (FMVSS 302), gute Beständigkeit gegen Kraftstoffe, Mineralöle und viele weitere Chemikalien

Einsatztemperatur: -40°C / +125°C
 Aufweitung: Aufstauchverhältnis 1 : 2

Material: Polyamide PA 6
 Monofil: Ø 0.25mm
 Properties: Highly flexible, self-adapting, resistant to abrasion, free of cadmium, formaldehyde, halogen and graphite, self-extinguishing acc. to DIN 75200 (FMVSS 302), good resistance to fuel, mineral oil and many other chemicals

Temperature range: -40°C / +125°C
 Expansion: Expansion ratio 1 : 2



Polyamid PA 6 Schwarz				Polyamide PA 6 Black	
NW	ø min mm	ø max mm	OFB %	Art.-Nr. Art. No.	
3	2.5	6.0	85	6850.40.03	100
4	3.0	8.5	91	6850.40.04	100
5	4.0	10.0	95	6850.40.05	100
6	4.0	9.0	85	6850.40.06	100
8	6.0	11.0	90	6850.40.08	100
10	7.0	13.5	90	6850.40.10	100
12	9.0	17.0	94	6850.40.12	100
14	10.0	22.0	85	6850.40.14	100
16	14.0	23.0	87	6850.40.16	100
18	16.0	24.0	88	6850.40.18	100
20	18.0	27.0	83	6850.40.20	100
22	18.0	32.0	84	6850.40.22	50
24	21.0	34.0	71	6850.40.24	50
25	18.0	34.0	85	6850.40.25	50
30	26.0	40.0	88	6850.40.30	50
35	28.0	40.0	88	6850.40.35	50
40	28.0	42.0	93	6850.40.40	50
45	38.0	58.0	84	6850.40.45	50
50	35.0	80.0	88	6850.40.50	50
70	55.0	80.0	91	6850.40.70	50

OFB = Oberflächendeckung
 Grau auf Anfrage

OFB = Percentage of the surface covered by fabric
 Colour grey on request



1
2
3
4
5
6
7
8
9
10
11
12

AGRO Geflechschläuche Kunststoff

AGRO synthetic braided cable sleeving

AGROflip B selbstschliessender Geflechschlauch | AGROflip B self-closing braided sleeving

AGROflip B selbstschliessender Geflechschlauch

Material:	Polyester PET
Monofil:	Ø 0.25mm
Einsatzbereich:	Problemloses Einziehen von vorkonfektionierten Kabeln, für nachträgliche Installation
Eigenschaften:	Hochflexibel, selbstanpassend, abriebfest, frei von Cadmium, Formaldehyd, Halogen und Graphit, selbstverlöschend nach DIN 75200 (FMVSS 302), gute Beständigkeit gegen Kraftstoffe, Mineralöle und viele weitere Chemikalien
Einsatztemperatur:	-50°C / +150°C

AGROflip B self-closing braided sleeving

Material:	Polyester PET
Monofil:	Ø 0.25mm
Application:	Sinking of pre-connected cables without problems, for additional installation
Properties:	Highly flexible, self-adapting, resistant to abrasion, free of cadmium, formaldehyde, halogen and graphite, self-extinguishing acc. to DIN 75200 (FMVSS 302), good resistance to fuel, mineral oil and many other chemicals
Temperature range:	-50°C / +150°C



AGROflip B Schwarz		AGROflip B Black		Art.-Nr. Art. No.	
NW	ø max mm				
6	6			6878.40.06	25
9	9			6878.40.09	25
13	13			6878.40.13	25
19	19			6878.40.19	20
25	25			6878.40.25	20
32	32			6878.40.32	20
38	38			6878.40.38	20
50	50			6878.40.50	20

Nominaler Innendurchmesser mit einer Überlappung von 25% / 90° Nominal inner diameter with 25% / 90° overlap



Thermischer Schutz bei hohen Temperaturen
Thermal protective qualities for high-temperature applications

Mit den AGROtube FRS Glasseidenschläuchen erweitert AGRO ihr Angebot an Geflechschläuchen um Produkte für Einsätze in Hochtemperaturbereichen.

Eigenschaften

Die Geflechte aus Glasfäden sind mit einer strapazierfähigen Silikon dispersion beschichtet, äusserst flexibel, dauerelastisch, scheuerfest, wasserabweisend und temperaturbeständig bis maximal 240°C. Als mechanischer Knick-, Abrieb- und Hitzeschutz sind sie bei der Kabelsatzherstellung unentbehrlich geworden. Die glatten Innenwände ermöglichen ein leichtes und schnelles Durchschieben einzelner Adern.

Als Isolierschläuche mit ausgezeichneten elektrischen Isolationseigenschaften lassen sich AGROtube FRS im Prinzip mit beliebig hoher Durchschlagfestigkeit ausstatten, wobei 2.5 bis 10 kV der Standard ist.

Anwendungsgebiete

Silikon beschichtete Glasseidenschläuche eignen sich ideal für den Einsatz im Schienenfahrzeugbau, den Bau von Transformatoren, Elektromotoren, Strom- und Messwandlern und für die Automobilindustrie. Die elektrischen Schutzqualitäten sind im Elektromaschinenbau für Drähte und Litzen gefragt. Thermische Schutzeigenschaften sind für Spulenanschlüsse oder Verbindungsleitungen thermisch hoch beanspruchter Maschinen von Bedeutung.

Ein klassisches Einsatzgebiet dieser Produkte ist die Elektrogeräteindustrie (Weisse Ware), in der es neben guten dielektrischen Werten auf hohe Temperaturbeständigkeit ankommt. Für die Verwendung als Walzenüberzüge z.B. in Durchlauföfen ist dagegen die hohe Abriebfestigkeit und der Antihafteffekt der Beschichtung von hoher Bedeutung.

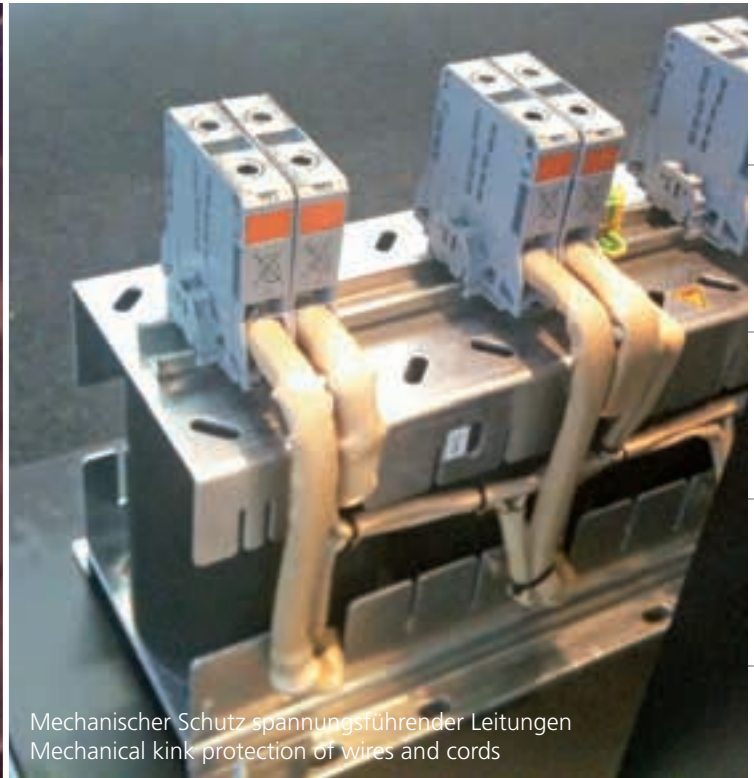

Mechanischer Schutz spannungsführender Leitungen
Mechanical kink protection of wires and cords

With the AGROtube FRS braided glass fibre sleeveings, AGRO is extending its range of braided sleeveings to include products for use in high-temperature applications.

Properties

Coated with a heavy-duty silicone dispersion, the meshwork made from glass filaments is extremely flexible, permanently elastic, abrasion-resistant, water-repellent and temperature-resistant up to a maximum of 240°C. As a mechanical kink, abrasion and heat protection, such meshworks have become indispensable in cable set production. The smooth inner walls make it easy and quick to push through individual leads.

As insulation tubes with excellent electric insulation properties, AGROtube FRS can in principle be endowed with any degree of electric strength, the standard strength being 2.5 to 10 kV.

Areas of application

Silicone-coated braided glass fibre sleeveings are ideally suited for use in the construction of rail vehicles, transformers, electric motors, current and instrument transformers, and in the automobile industry. The electric protective qualities are sought after in the construction of electric motors for wires and cords. Thermal protective properties are important for coil connections or connecting lines of machines under intense thermal conditions.

A classic application area of these products is the electric appliances industry (whiteware) where both good dielectric values and high temperature resistance are vital.

In contrast, for use as roll covers, e.g. in continuous furnaces, high abrasion resistance and the anti-adhesive effect of the coating are of great importance.

AGROtube FRS Glasseidenschläuche mit Silikonummantelung

AGROtube FRS Braided glass fibre sleeving with silicone coating

Glasseidenschlauch mit Silikonbeschichtung | Braided glass fibre sleeve with silicone sheath

Material:	Glasseide	Material:	E-glass braidGlass fibre
Beschichtung:	Silikon FRS	Sheath:	Silicone FRS
Eigenschaften:	Hochflexibel, abriebfest, hitzebeständig mit vorzüglichen elektrischen Eigenschaften. Nicht adhäsive Oberfläche mit hervorragender Öl- und Dieselmotorenstoff-Beständigkeit	Characteristics:	highly flexible, abrasion resistant, heat-resisting with excellent electric properties. Non adhesive surface with outstanding oil and diesel fuel resistance
Brandverhalten:	FMVSS 302 (DIN 75200) -40°C / +240°C	Flammability:	FMVSS 302 (DIN 75200)
Durchschlagsfestigkeit (DF):	2.5 kV	Temperature range:	-40°C / +240°C
		Dielectric strength: (DS):	2.5 kV

AGROtube FRS

Glasseidenschläuche						Braided glass fibre sleeve					
Typ.-Nr.	transparent transparent	gelb yellow	schwarz black	grün green	rot red	Ø I Code	DF DS	Ø I mm	Ø A mm		
6877	10	30	40	50	60	010	25	1.0	1.8	50	
6877	10	30	40	50	60	015	25	1.5	2.3	50	
6877	10	30	40	50	60	020	25	2.0	2.8	50	
6877	10	30	40	50	60	025	25	2.5	3.4	50	
6877	10	30	40	50	60	030	25	3.0	3.9	50	
6877	10	30	40	50	60	035	25	3.5	4.4	50	
6877	10	30	40	50	60	040	25	4.0	4.9	50	
6877	10	30	40	50	60	045	25	4.5	5.4	50	
6877	10	30	40	50	60	050	25	5.0	6.0	50	
6877	10	30	40	50	60	060	25	6.0	7.0	50	
6877	10	30	40	50	60	070	25	7.0	8.0	50	
6877	10	30	40	50	60	080	25	8.0	9.0	50	
6877	10	30	40	50	60	090	25	9.0	10.0	50	
6877	10	30	40	50	60	100	25	10.0	11.2	50	
6877	10	30	40	50	60	120	25	12.0	13.2	50	
6877	10	30	40	50	60	140	25	14.0	15.4	50	
6877	10	30	40	50	60	160	25	16.0	17.4	50	
6877	10	30	40	50	60	180	25	18.0	19.4	50	
6877	10	30	40	50	60	200	25	20.0	21.5	50	
6877	10	30	40	50	60	220	25	22.0	23.5	50	
6877	10	30	40	50	60	250	25	25.0	26.5	50	
6877	10	30	40	50	60	280	25	28.0	29.6	50	
6877	10	30	40	50	60	300	25	30.0	31.6	50	

So definieren Sie die Produktnummer:
That's how to compose the product number:

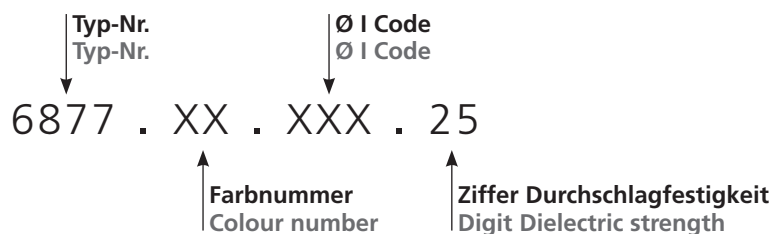

6877.50.035.25 ist ein grüner Schlauch mit Innendurchmesser 3.5 mm und einer Durchschlagsfestigkeit von 2.5 kV
6877.50.035.25 stands for a green sleeving with inner diameter of 3.5 mm and a dielectric strength of 2.5 kV

AGROtube FRS Glasseidenschläuche mit Silikonummantelung

AGROtube FRS Braided glass fibre sleeving with silicone coating

Glasseidenschlauch mit Silikonbeschichtung | Braided glass fibre sleeve with silicone sheath

Material:	Glasseide	Material:	E-glass braid
Beschichtung:	Silikon FRS	Sheath:	Silicone FRS
Eigenschaften:	Hochflexibel, abriebfest, hitzebeständig mit vorzüglichen elektrischen Eigenschaften. Nicht adhäsive Oberfläche mit hervorragender Öl- und Dieselmotoren-Beständigkeit	Characteristics:	highly flexible, abrasion resistant, heat-resisting with excellent electric properties. Non adhesive surface with outstanding oil and diesel fuel resistance
Brandverhalten:	FMVSS 302 (DIN 75200)	Flammability:	FMVSS 302 (DIN 75200)
Einsatztemperatur:	-40°C / +240°C	Temperature range:	-40°C / +240°C
Durchschlagsfestigkeit (DF):	4.0 kV	Dielectric strength: (DS):	4.0 kV

AGROtube FRS

Typ.-Nr.	Glasseidenschläuche					Braided glass fibre sleeve					
	transparent	gelb	schwarz	grün	rot	Ø I Code	DF DS	Ø I mm	Ø A mm		
6877	10	30	40	50	60	010	40	1.0	1.8	50	
6877	10	30	40	50	60	015	40	1.5	2.3	50	
6877	10	30	40	50	60	020	40	2.0	2.8	50	
6877	10	30	40	50	60	025	40	2.5	3.4	50	
6877	10	30	40	50	60	030	40	3.0	3.9	50	
6877	10	30	40	50	60	035	40	3.5	4.4	50	
6877	10	30	40	50	60	040	40	4.0	4.9	50	
6877	10	30	40	50	60	045	40	4.5	5.4	50	
6877	10	30	40	50	60	050	40	5.0	6.0	50	
6877	10	30	40	50	60	060	40	6.0	7.0	50	
6877	10	30	40	50	60	070	40	7.0	8.0	50	
6877	10	30	40	50	60	080	40	8.0	9.0	50	
6877	10	30	40	50	60	090	40	9.0	10.0	50	
6877	10	30	40	50	60	100	40	10.0	11.2	50	
6877	10	30	40	50	60	120	40	12.0	13.2	50	
6877	10	30	40	50	60	140	40	14.0	15.4	50	
6877	10	30	40	50	60	160	40	16.0	17.4	50	
6877	10	30	40	50	60	180	40	18.0	19.4	50	
6877	10	30	40	50	60	200	40	20.0	21.5	50	
6877	10	30	40	50	60	220	40	22.0	23.5	50	
6877	10	30	40	50	60	250	40	25.0	26.5	50	
6877	10	30	40	50	60	280	40	28.0	29.6	50	
6877	10	30	40	50	60	300	40	30.0	31.6	50	

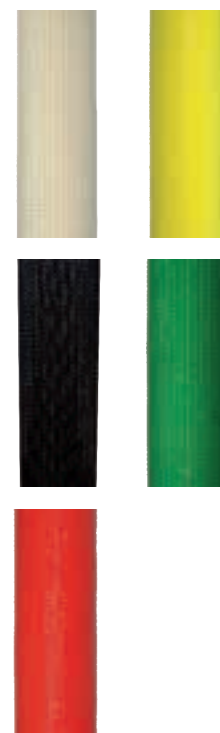

So definieren Sie die Produktnummer:
That's how to compose the product number:

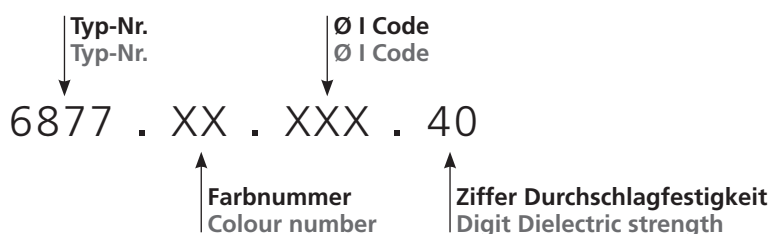

6877.50.035.40 ist ein grüner Schlauch mit Innendurchmesser 3.5 mm und einer Durchschlagfestigkeit von 4.0 kV
6877.50.035.40 stands for a green sleeving with inner diameter of 3.5 mm and a dielectric strength of 4.0 kV

AGROtube FRS Glasseidenschläuche mit Silikonummantelung

AGROtube FRS Braided glass fibre sleeving with silicone coating

Glasseidenschlauch mit Silikonbeschichtung | Braided glass fibre sleeve with silicone sheath

Material:	Glasseide	Material:	E-glass braid
Beschichtung:	Silikon FRS	Sheath:	Glass fibre
Eigenschaften:	Hochflexibel, abriebfest, hitzebeständig mit vorzüglichen elektrischen Eigenschaften. Nicht adhäsive Oberfläche mit hervorragender Öl- und Dieselmotortreibstoff-Beständigkeit	Characteristics:	Silicone FRS highly flexible, abrasion resistant, heat-resisting with excellent electric properties. Non adhesive surface with outstanding oil and diesel fuel resistance
Brandverhalten:	FMVSS 302 (DIN 75200)	Flammability:	FMVSS 302 (DIN 75200)
Einsatztemperatur:	-40°C / +240°C	Temperature range:	-40°C / +240°C
Durchschlagsfestigkeit (DF):	7.0 kV	Dielectric strength: (DS):	7.0 kV

AGROtube FRS

Glasseidenschläuche						Braided glass fibre sleeve					
Typ.-Nr.	transparent transparent	gelb yellow	schwarz black	grün green	rot red	Ø I Code	DF DS	Ø I mm	Ø A mm		
6877	10	30	40	50	60	010	70	1.0	1.8	50	
6877	10	30	40	50	60	015	70	1.5	2.3	50	
6877	10	30	40	50	60	020	70	2.0	2.8	50	
6877	10	30	40	50	60	025	70	2.5	3.4	50	
6877	10	30	40	50	60	030	70	3.0	3.9	50	
6877	10	30	40	50	60	035	70	3.5	4.4	50	
6877	10	30	40	50	60	040	70	4.0	4.9	50	
6877	10	30	40	50	60	045	70	4.5	5.4	50	
6877	10	30	40	50	60	050	70	5.0	6.0	50	
6877	10	30	40	50	60	060	70	6.0	7.0	50	
6877	10	30	40	50	60	070	70	7.0	8.0	50	
6877	10	30	40	50	60	080	70	8.0	9.0	50	
6877	10	30	40	50	60	090	70	9.0	10.0	50	
6877	10	30	40	50	60	100	70	10.0	11.2	50	
6877	10	30	40	50	60	120	70	12.0	13.2	50	
6877	10	30	40	50	60	140	70	14.0	15.4	50	
6877	10	30	40	50	60	160	70	16.0	17.4	50	
6877	10	30	40	50	60	180	70	18.0	19.4	50	
6877	10	30	40	50	60	200	70	20.0	21.5	50	
6877	10	30	40	50	60	220	70	22.0	23.5	50	
6877	10	30	40	50	60	250	70	25.0	26.5	50	
6877	10	30	40	50	60	280	70	28.0	29.6	50	
6877	10	30	40	50	60	300	70	30.0	31.6	50	

So definieren Sie die Produktnummer:
That's how to compose the product number:

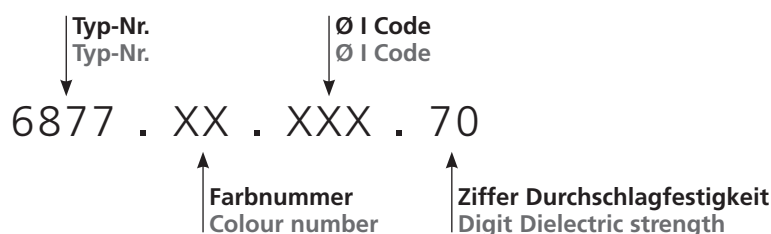

6877.50.035.70 ist ein grüner Schlauch mit Innendurchmesser 3.5 mm und einer Durchschlagsfestigkeit von 7.0 kV.
6877.50.035.70 stands for a green sleeving with inner diameter of 3.5 mm and a dielectric strength of 7.0 kV



Prüfzeichen Approval Marks	240 - 241	1
Brandschutz für Schienenfahrzeuge nach EN 45545 Fire protection in railway vehicles according to EN 45545	242 - 243	2
Progress® Baukasten und AGRO Sonderlösungen Progress® modular assembly parts and AGRO special solutions	244 - 249	3
AGRO Prüftechnik AGRO Test laboratory	250 - 251	4
Montageanleitungen Kabelverschraubungen Assembly instructions cable glands	252 - 255	5
AGRO digitaler Service AGRO digital service	256	6
Verzeichnis der Schutzarten (IP) List of Protection Classes (IP)	257	7
Materialübersichtstabellen List of materials	258 - 261	8
Gewindetabelle Chart of threads	262	9
Suchhilfen Search helps	263 - 272	10
		11



SEV

Das SEV-Bewilligungszeichen wird auf Grund bestandener Prüfungen bei ElectroSuisse vom ESTI erteilt. Grundlage für Kabelverschraubungen ist hierbei die europäische Norm EN 50262 / EN 62444.

SEV

The SEV mark of approval is awarded by ESTI as a result of tests conducted by ElectroSuisse. European standard EN 50262 / EN 62444 forms the basis for cable glands.



VDE

Das VDE-Zeichen kennzeichnet die Konformität mit den VDE-Bestimmungen bzw. europäischen oder international harmonisierten Normen und bestätigt die Einhaltung der Schutzanforderungen der zutreffenden Richtlinien. Das VDE-Zeichen steht für die Sicherheit des Produktes hinsichtlich elektrischer, mechanischer, thermischer und sonstiger Gefährdung.

VDE

The VDE certification mark signals conformity with the VDE provisions and European or internationally harmonised standards and confirms that the safety requirements fulfil the applicable guidelines. The VDE mark stands for the safety of the product in terms of electrical, mechanical, thermal and other hazards.



C-UL / US Listing Zeichen

Dieses Prüfzeichen wird bei Produkten verwendet, die auf kanadischen und U.S.-Märkten vertrieben werden. Es weist darauf hin, dass die kanadischen und die U.S.-Anforderungen für klassifizierbare Produkte erfüllt wurden.

C-UL / US Listing Mark

This approval mark is used for products that are distributed in the US and Canadian markets. It indicates that the US and Canadian specifications for classifiable products have been fulfilled.



Recognized Component Zeichen für Kanada und die USA

Das Recognized Component Mark von UL darf für Komponenten verwendet werden, die Bestandteil eines grösseren Produktes oder Systems sind. Diese sind von UL gemäss kanadischen und U.S.-Anforderungen zertifiziert.

Recognized Component Mark for Canada and the USA

The UL Recognized Component Mark can be used for components that are part of a larger product or system. These are certified by UL in accordance with US and Canadian requirements.



Das **GOST-R-Zertifizierungszeichen** kennzeichnet die Übereinstimmung der Produkte mit russischen Richtlinien und Normen. Grundlage dafür bilden das russische Verbraucherschutzgesetz sowie das Gesetz zur Zertifizierung von Gütern und Dienstleistungen. Produkte welche in Russland produziert wurden, sowie Importwaren müssen den jeweiligen Standards entsprechen, wenn sie in den russischen Markt gelangen.

The **GOST-R certification mark** indicates that products conform to the Russian guidelines and standards. The basis is given by the Russian consumer protection act and the law governing the certification of goods and services. Products produced in Russia, as well as imported goods, must conform to the relevant standards when they appear on the Russian market.

Det Norske Veritas (DNV) ist eine Schiffsklassifikations-Gesellschaft in Form einer Stiftung. Sie klassiert und erteilt Zertifikate zum unbedenklichen Einsatz von Produkten auf Schiffen. DNV wurde 1864 in Oslo gegründet

Det Norske Veritas (DNV) is a maritime classification society organized as a foundation. It classifies and issues certificates for the safe use of materials and components on ships. DNV was founded in 1864 in Oslo.



1

Die **Internationale Elektrotechnische Kommission**, kurz: IEC (von engl. International Electrotechnical Commission) ist eine internationale Normungsorganisation mit Sitz in Genf für Normen im Bereich der Elektrotechnik und Elektronik.

The **International Electrotechnical Commission (IEC)** is an international standards organisation with its headquarters in Geneva which develops standards in the areas of electrical equipment and electronics.



2

Das IEC Ex-Prüfzeichen ist eine spezielle Kennzeichnung für Explosionsschutz Einrichtungen. Es bedeutet, dass Einrichtungen, Schutzsysteme oder Bauteile den Anforderungen der internationalen und europäischen Norm entsprechen, die mit der Richtlinie 94/9/EC (ATEX-Direktive, benannt nach der französischen Bezeichnung „ATmosphère EXplosible“) harmonisiert sind.

The IEC Ex mark of conformity is a special identification for equipment and services used in explosive atmospheres. It means that equipment, protective systems or components meet the requirements of the international and European standard which are harmonised with Directive 94/9/EC (the ATEX directive, named after the French designation "ATmosphères EXplosives").



4

„**Restriction of the use of certain Hazardous Substances in electronic equipment**“ ist der Titel der EU-Richtlinie 2002/95/EG. Sie verbietet ab 1.7.2006 im gesamten Gebiet der EU den Verkauf von elektrischen Geräten, welche mehr als nur Spuren von Blei, Cadmium, Chrom VI, Quecksilber oder von polybromierten Flammschutzmitteln PBB/PBDE enthalten.

“**Restriction of the use of certain Hazardous Substances in electronic equipment**“ is the title of EC Directive 2002/95/EC. With effect from 1 July 2006, it forbids the sale of electric equipment which contain more than traces of lead, cadmium, chromium(VI), mercury or polybrominated flame retardants (PBBs and PBDEs) throughout the entire EC.

RoHS

5

Die neue Norm EN 45545 Brandschutz in Schienenfahrzeugen ist seit Juni 2013 in Kraft und bringt innerhalb Europas eine Vereinheitlichung. Nationale Normen wie DIN 5510-2, NFF 16101 / 102 oder UNICEI 11170 werden bis März 2016 zurückgezogen.

Die neue Brandschutznorm setzt sich aus mehreren Teilen zusammen. Teil 1 umfasst allgemeine Regeln, Teil 2(EN 45545-2) definiert die Anforderungen an das Brandverhalten von Materialien und Komponenten nach verschiedenen Gefährdungsstufen (Hazard Level). Teil 2 ist in Bezug auf gefährliche Rauchgase sehr wichtig. Teil 3 (EN 45545-3) definiert den Feuerwiderstand von Feuerschutzabschlüssen (Raumabschluss).

The new standard EN 45545 Fire protection on railway vehicles came into effect in June 2013, bringing standardisation across Europe. National standards such as DIN 5510-2, NFF 16101 / 102 and UNICEI 11170 will be withdrawn by March 2016.

The new fire protection standard consists of several parts. While Part 1 covers general requirements, Part 2 (EN 45545-2) outlines requirements for fire behaviour of materials and components according to various Hazard Levels. Part 2 is very important in relation to dangerous smoke gases. Part 3 (EN 45545-3) defines fire resistance requirements for fire barriers.

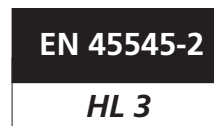

6

7

8

9

10

11

12

AGRO Kabelverschraubungen sind zertifiziert nach EN 45545-2

AGRO cable glands are certified according to EN 45545-2

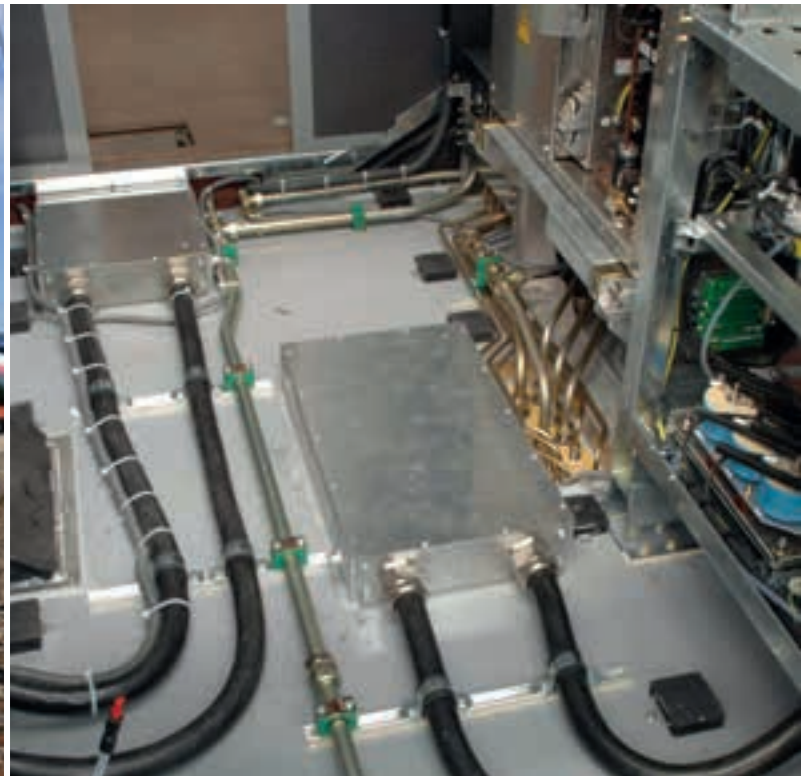

AGRO Progress® bedenkenlos für Schienenfahrzeuge

AGRO Progress® Kabelverschraubungen aus Metall können bedenkenlos für alle Anwendungen und Anordnungen im Schienenfahrzeugbereich eingesetzt werden. Dies bescheinigt das neue Zertifikat.

Die herausragende Progress® Kompressionstechnik sorgt für eine hohe Dichtigkeit und eine äusserst kabelschonende Zugentlastung auch bei dynamischen Anwendungen. Standard- und EMV-Kabelverschraubungen mit dem entsprechenden Zubehör bilden das Basissortiment für nahezu alle Anwendungen. AGRO fertigt bei Bedarf auch zertifizierte Lösungen gemäss Anforderungen der Kunden.

Beste Resultate bei Prüfungen nach EN 45545-2 (Komponenten)

Die Dichteinsätze der Progress® Kabelverschraubung sind aus einem speziellen TPE gefertigt und sind im anspruchsvollsten **Hazard Level 3 zertifiziert**.

Die geforderten Werte für Hazard Level 3 wurden sowohl im Ausen- als auch im Innenbereich deutlich übertroffen:

AGRO Progress® - the ideal solution for rolling stock

AGRO Progress® metal cable glands can be used with confidence for any rolling stock application, in any arrangement, as has been recently certified.

The outstanding Progress® compression technology ensures tight seals and offers cables exceptional damage-preventing strain relief, even in dynamic applications. A comprehensive range of standard and EMC cable glands and accessories offers a solution for almost any application. Where the need arises, AGRO also delivers certified solutions according to customer requirements.

Best results in testing according to EN 45545-2 (Components)

The seal inserts of Progress® cable glands are made from a special TPE and certified to the demanding **Hazard Level 3**.

The stipulated values for Hazard Level 3 were exceeded, for both indoor and outdoor areas:

	Normwert für HL 3 aussen Requirement for HL 3 outdoor	Normwert für HL 3 innen Requirement for HL 3 indoor	AGRO Resultat AGRO result
Sauerstoffindex Oxygen index	Min. 32%	Min. 32%	39%
Rauchgasdichte Ds Smoke gas density Ds	Max. 300	Max. 150	110
Toxizität CIT Toxicity CIT	Max. 1.5	Max. 0.75	0.16

Kabelverschraubungen zertifiziert für den Einsatz in Schienenfahrzeugen Cable glands certified for rolling stock applications



Material: Messing vernickelt
Material Dichteinsatz: Spezial AGRO TPE
Farbe Dichteinsatz: Hellgrau RAL 7035
Gewinde: M12 bis M63
Pg 7 bis Pg48
Einsatztemperatur: -50°C / +105°C
Schutzart: IP 68 / IP 69 K
Weitere Normen: EN 50262 / EN 62444

Material: Nickel-plated brass
Material sealing insert: Spezial AGRO TPE
Colour sealing insert: Light grey RAL 7035
Threads: M12 to M63
Pg 7 to Pg48
Temperature range: -50°C / +105°C
Protection class: IP 68 / IP 69 K
Further norms: EN 50262 / EN 62444



AGRO Kabelverschraubungen sind zertifiziert nach EN 45545-3

AGRO cable glands are certified according to EN 45545-3



Ausgangssituation | Initial situation

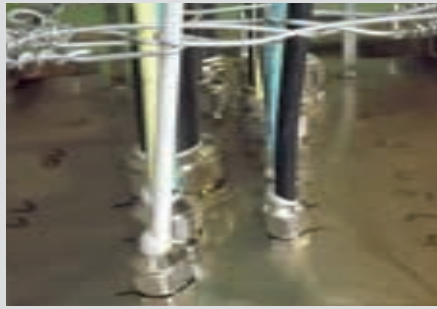

Nach 10 Minuten | After 10 minutes



Nach 20 Minuten | After 20 minutes



Nach 30 Minuten | After 30 minutes



Nach 35 Minuten | After 35 minutes



Nach 44 Minuten | After 44 minutes

Vorgaben der EN 45545-3 übertroffen!

Die EN 45545-3 definiert die Anforderungen an den Feuerwiderstand für Feuerschutzabschlüsse. Ziel der EN 45545-3 ist es, die Brandausbreitung durch Materialanforderungen zu begrenzen. Wenn Kabel durch Feuerschutzabschlüsse geführt werden, gelten diese Anforderungen auch für Kabelverschraubungen.

Um festzustellen, ob der geforderte Feuerwiderstand erreicht wird, werden die Komponenten in einem Prüfofen in Hinblick auf die Kriterien Raumabschluss, Wärmedämmung und Strahlenemission geprüft.

AGRO Progress® Kabelverschraubungen aus Metall übertreffen die Vorgaben der EN 45545-3 bei weitem und erreichen die sehr hohe Feuerwiderstandsklasse E30. Dies bedeutet, dass die Dichteinsätze mindestens 30 Minuten lang dicht sind und einen Flammenübertrag auf die dem Feuer abgewandte Seite verhindern. Es bilden sich keine Spalten. Sie können aus brandschutztechnischer Sicht bedenkenlos in allen Schienenfahrzeugen eingesetzt werden.

Exceeding the demands of EN 45545-3!

EN 45545-3 defines the requirements for fire resistance of fire barriers. The aim of EN 45545-3 is to limit fire spread by specifying the performance of materials and components. If cables are routed through fire barriers, the requirements apply also to the cable glands used.

In order to establish whether or not the required fire resistance is achieved, components are tested in a testing furnace with respect to requirements for fire barrier, thermal insulation and radiation emission.

AGRO Progress® metal cable glands easily exceed the requirements of EN 45545-3 and satisfy the very high demands of fire resistance class E30. This means that the seal inserts remain impervious and prevent the spread of fire through the gland for at least 30 minutes. They do not crack or fissure. From a fire protection perspective, they can be used without hesitation in all railway vehicles.



	Einbaulage vertikal Vertical installation	Einbaulage horizontal Horizontal installation	Klassierung Classification
AGRO Resultat AGRO Result	44 min	41 min	E30

Der Brandversuch wurde durchgeführt mit AGRO Progress® Kabelverschraubungen Messing vernickelt und Dichteinsätzen aus Spezial AGRO TPE, Größen M16 bis M50, sowie mit Multi-Kabelverschraubungen und Verschlusschrauben.

Fire testing was carried out using AGRO Progress® nickel-plated brass cable glands and seal inserts of Special AGRO TPE, sizes M16 to M50, and with multi-cable glands and locking screws.

Progress®: Der Baukasten – Messing

Progress®: Modular assembly parts – nickle-plated brass

Progress®-Bauteile können frei kombiniert werden

Progress® components are freely combineable

Oberteil / Upper part



Standard-Druckmutter
Standard compression nut



Knickschutz
Antikink spring



Trompete
Trumpet



Klemmbacken und Trompete
Trumpet with clamps



Klemmbacken
Clamps



Schlauchverschraubungen
Conduit glands

Dichteinsatz / Sealing inserts



Kurzer ein- oder zweiteiliger Dichteinsatz in NBR/TPE, Spezial TPE nach EN 45545 oder FPM (temperaturbeständig)
Short one or two-piece sealing insert made of NBR, TPE, special TPE according to EN 45545 or FPM (heat resistant)

Langer durchgehend isolierender Dichteinsatz in NBR/TPE oder Spezial TPE nach EN 45545, ein- oder zweiteilig / Long one or two-piece overall length insulating sealing insert made of NBR/TPE, special TPE acc. to EN 45545

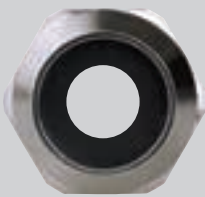

mit Standard-Bohrungen
with standard holes



mit individuellen Öffnungen
with customised holes

Unterteil / Lower Part



mit kurzem Anschlussgewinde
with short entry thread

- metrisch / metric
- Pg / Pg
- NPT / NPT
- Gasrohr / gaspipe



mit langem Anschlussgewinde
with long entry thread

- metrisch / metric
- Pg / Pg
- NPT / NPT
- Gasrohr / gaspipe

Individualisierungen sind prinzipiell auf jeder Stufe des Baukastens möglich.
Customisations are possible essentially at every stage of the building block approach.

Kundenspezifische Oberteile Customised upper parts



Oberteile können im Hinblick auf die Bauform und das Gewinde individualisiert werden.

In Zusammenarbeit mit den Kunden wird ein Bauteil entwickelt, welches den individuellen Anforderungen am Besten entspricht und den optimalen Nutzen bietet.

Upper parts can be customised for shape and thread. By working closely with the customer, a component is developed which best meets individual requirements and offers superior benefit to the user.

Individualisierte Dichteinsätze Customised sealing inserts



Dichteinsätze können bezüglich Form und Anzahl der Durchführungen sowie der Materialwahl individualisiert werden. Wir bearbeiten folgende Materialien:

- NBR
- TPE
- TPE-V
- FPM
- Silikonkautschuk
- HNBR
- EPDM
- Spezial TPE

Sealing inserts can be customised for shape and number of feedthroughs and also with regard to the selection of material. We work with the following materials:

- NBR
- TPE
- TPE-V
- FPM
- Silicone caoutchouc
- HNBR
- EPDM
- Special TPE

Kundenspezifische Unterteile Customer-specific lower parts



Unterteile können bezüglich Art und Länge des Anschlussgewindes individualisiert werden. Alle technischen Gewinde sind möglich.

Lower parts can be customised for type and length of the entry thread. All technical thread types are available.

Sonderlösung Schienenfahrzeug

Special solutions for railway vehicles

Anforderungen

- EMV-gerechte Einführung von sechs ungeschirmten Kabeln
- Verbindung Stromrichter - Trafo
- Schutzart IP68 innen und aussen. Dadurch wird verhindert, dass Kondenswasser, welches sich möglicherweise innerhalb des Schlauches bildet, in den Traforaum eindringt

AGRO-Lösung

- Progress®-Spezialverschraubung M75 mit geschlitztem Multi-Dicht-einsatz zur leichteren Kabelmontage
- kombiniert mit Metallschutzschlauch

Requirements

- EMC-proof feedthrough of six unshielded cables
- Connection from power rectifier to transformer
- Protection class IP68 inside and out. This prevents condensate which could possibly build up inside the conduits from making its way into the transformer room

The AGRO solution

- Progress® M75 special cable gland with slotted multi-sealing insert for easier cable assembly
- Combined with metal conduit

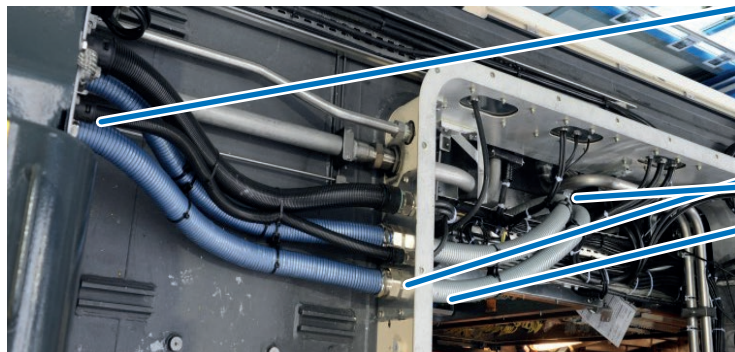

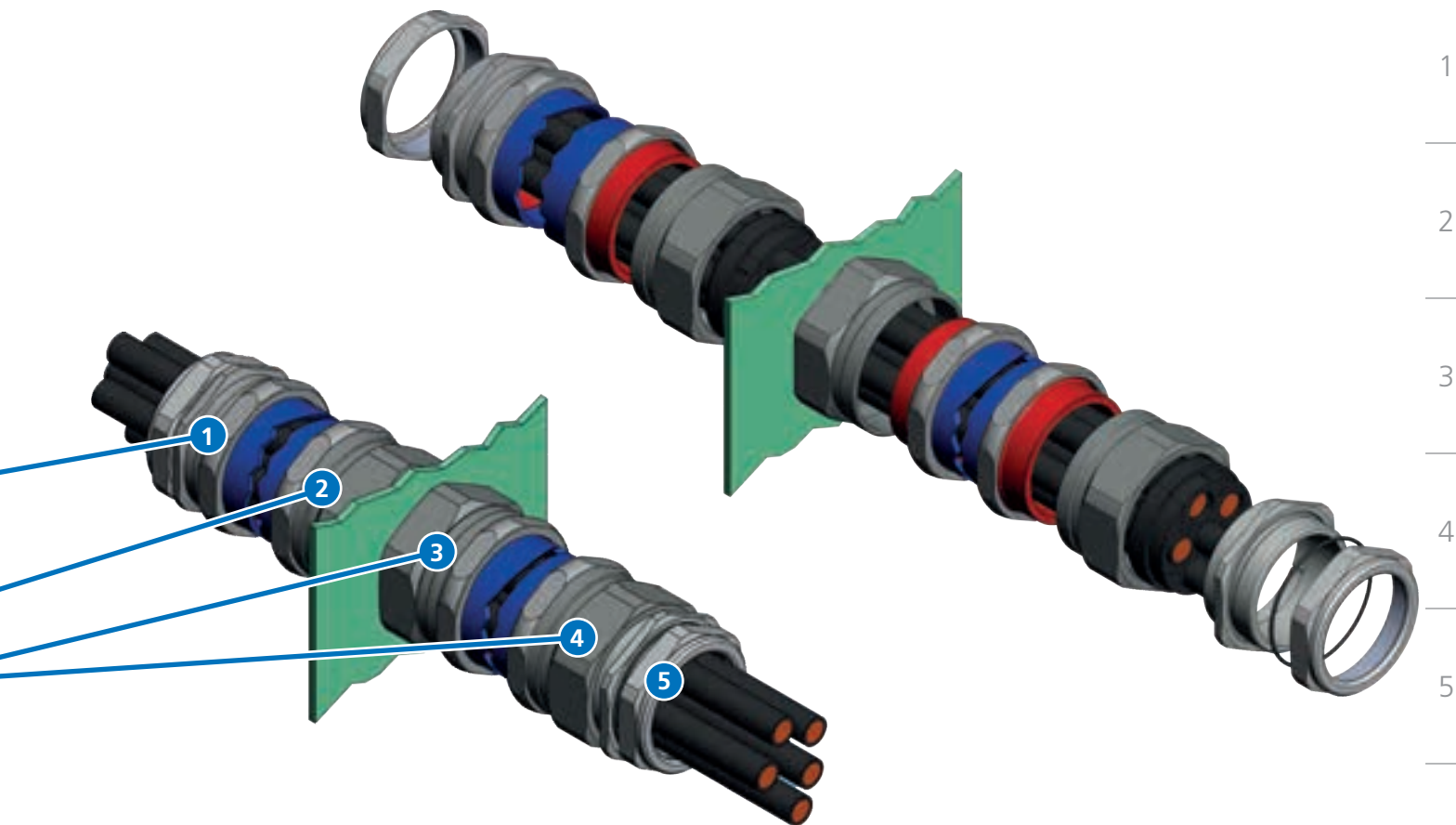

- 1 Schlauchverschraubung zur Befestigung des Metall-Kabelschutzschlauches. Innerhalb des Schutzschlauches werden sechs Stromkabel geführt. Der Metallschutzschlauch funktioniert über seine Verbindung mit den Gehäusen aus Metall als äußerer EMV-Schutz
- 2 Kombi-Schlauchverschraubung mit Progress® Multi-Dichteinsatz zur dichten Einführung der Kabel in den Traforaum (Schutz vor Feuchtigkeit von aussen)
- 3 Schlauchverschraubung zur Aufnahme des Metallschutzschlauches (Weiterführung des EMV-Schutzes)
- 4 Kombi-Schlauchverschraubung (identisch mit 2) zur Einführung der Kabel in den Trafo (Schutz vor Feuchtigkeit von innen)
- 5 Gegenmutter zur Befestigung der Kombi-Schlauchverschraubung

- 1 Conduit gland to secure the metal conduit. Six power cables are run within the conduit. The metal conduit functions as an exterior EMC shield through its connection with the metal enclosures
- 2 Combination conduit gland with Progress® multi-sealing insert for sealed cable feedthrough into the transformer room (protection from outside moisture)
- 3 Conduit gland to accept the metal conduit (extension of EMC protection)
- 4 Combination conduit gland (identical to #2) for cable feedthrough into the transformer room (protection from interior moisture)
- 5 Locknut to secure the combination conduit gland

Sonderlösung Kabelverschraubung Knabberschutz

Rodent-proof special cable gland solution



© ABB

Wenn Nager zum Sicherheitsrisiko werden

Manch einer kennt das Phänomen aus eigener Erfahrung: das Auto will sich am Morgen nicht starten lassen, und der Reparaturdienst stellt fest, dass Gummiteile von Mardern weggefressen worden sind.

Marder, Nager und Vögel lieben Gummi. Die Konsistenz und der Duft von Gummi zieht Kleintiere an und sie knabbern ihn an. Frei geknabberte Kabel führen zu Kurzschlüssen und Funktionsstörungen. Wenn ummantelte Kabel in einem natürlichen Umfeld eingesetzt werden, so muss mit einem Nagerschaden gerechnet werden und entsprechende Vorsichtsmassnahmen sind sinnvoll.



Nagerschaden an Kabel / Rodent damage to a cable

ABB baut Schaltanlagen, die in der ganzen Welt unter unterschiedlichsten Umweltbedingungen eingesetzt werden.

Möglichen Schäden durch Nager wird standardmässig vorgebeugt, indem die Kabel, welche Generatorschutzschalter und Steuer-schrank verbinden, in einem mit Polyurethan ummantelten flüssigkeitsdichten Schlauch mit Stahlwendel geführt werden. Zur IP68 dichten Einführung der im Schlauch geführten Kabel entwickelte AGRO in Zusammenarbeit mit ABB eine individualisierte Lösung, welche eine feuchtigkeitsdichte Verbindung von Schlauch- und Kabelverschraubung sowie einen sicheren EMV Abgriff ermöglicht. Mit dieser Lösung werden zwei Probleme auf einmal gelöst: die Kabelführung und -Einführung ist feuchtigkeitsdicht und vor Nager geschützt.

248 | www.agro.ch

When rodents become a safety risk

Many of us know the phenomenon from personal experience: the car just won't start in the morning and the mechanic finds that rubber parts have been gnawed away by martens. Just like martens, rodents and also birds love rubber. Small animals seem to be magically drawn to rubber by its consistency, or maybe its scent, and nibble away at it.

Damaged cables can result in short circuits and loss of functionality. If shrouded cables are to be used in a natural setting, the risk of rodent damage should be recognised and appropriate precautions taken.



Nager sicherer Kabelschutz mit Progress® EMV Serie 85 / Rodent proof cable protection

ABB manufactures gas insulated switchgear that is used all around the world in the most varying environments. Possible damage by rodents is prevented, as standard, by the use of a polyurethane-sheathed, liquid-tight conduit with a steel coil to protect cables connecting circuit breakers and control cabinets.

For the IP68-compliant entry of the cable into the conduit, AGRO developed, in cooperation with ABB, an individualised solution which facilitates a liquid-tight connection of conduit and cable and a reliable EMC tap.

This solution solves two problems at once: the cable route, and in particular the entry point of the cable into the conduit, are liquid-tight, and the cable is also protected from rodents.

Anforderungen

- Die Anforderung an Ausrüstungsmaterialien in der Signalisationstechnik sind hoch. Bei Signalisationsanlagen im Bahnbereich muss die Anlage schlagfest sein (Schotterschlag)
- Kabel sollten mit einem Schlauch vor Schotterschlag geschützt werden. Die Verbindung Kabelverschraubung - Schlauch sollte auf möglichst einfache Weise erstellt werden.

AGRO-Lösung

- Mit einer speziellen Schlauchanschlusshülse wurde eine einfache und ausreissichere Aufnahme für den Schutzschlauch geschaffen

- 1 Die Standard Progress® Kabelverschraubung wird ergänzt durch die Schlauchanschlusshülse zur Aufnahme des Kabelschutzschlauches.
- 2 Eine Verschlusskappe verschliesst die Kabeleinführung mit Dichtigkeit IP 68, solange sie unbestückt bleibt.

Requirements

- The requirements on equipment used in signalisation are very high. With railway signalisation, the systems must be impact resistant (from crushed stone).
- Cables must be protected from impact due to crushed stone using conduit. The cable gland/conduit connection must be created in the simplest way possible.

The AGRO solution

- A simple and pull-out resistant attachment to the conduit was created with a special conduit connecting sleeve

- 1 The standard Progress® cable gland is enhanced with the conduit connecting sleeve for attachment to the cable conduit.
- 2 A sealing cap closes the cable entry with a robust IP68 seal as long as it is not fitted.

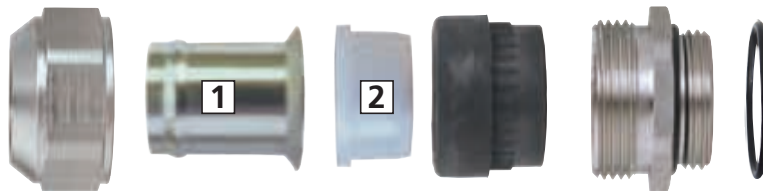

Standard Progress® Kabelverschraubung ergänzt mit einer Schlauchanschlusshülse.

Standard Progress® cable gland enhanced with a conduit connecting sleeve

Spezialausführung Druckmutter mit integrierter Schlauchanschlusshülse.

Special compression nut with integrated conduit connector.



1
2
3
4
5
6
7
8
9
10
11



Glühdrahttest bei 850°C
Glow wire test at 850°C



Druckprüfung zur Ermittlung des IP Schutzes
Pressure test for the determination of the degree of IP protection

Das Arbeiten und Leben mit Strom birgt Risiken. Normen und staatliche Richtlinien wollen diese Risiken minimieren und Installateuren, Monteuren und zu guter Letzt auch dem Endnutzer mehr Sicherheit bieten.

Geprüfte und zertifizierte Produkte geben dem Installateur Sicherheit bei der Montage und die Gewissheit, dass das Produkt seine Funktion über viele Jahre erfüllen wird. Ausserdem bleibt die abschliessende Haftung bei einem durch Electrosuisse zertifizierten Produkt im Schadenfall beim Hersteller der Komponente.

AGRO liess ihr Labor von Electrosuisse überprüfen, weil sie das **TMP-Zertifikat** anstrebte. TMP bedeutet: Testing at manufacturer premises. Die offizielle Zertifizierungsstelle stellt fest: „Das AGRO-Prüflabor erfüllt die relevanten Kriterien für die Anerkennung von Prüfberichten nach OD ECS 37 und sie entsprechen den Anforderungen von ISO/IEC 17025:2005 (Allgemeine Anforderungen an die Kompetenz von Prüf- und Kalibrierlaboratorien).“ Im Klartext heisst dies: „AGRO AG verfügt über das nötige normative Wissen, um Produkte schnell und sicher zu prüfen. Die Prüfberichte des Labors sind die Grundlage für die Zertifizierung eines Produkts durch Electrosuisse.“

Was nützt das dem Kunden aus der Elektrobranche, Maschinen und Automatisierungsindustrie?

Working and living with electricity inevitably involves risks. Standards and government directives have the goal of minimising these risks and offering additional safety to electricians, fitters and most of all the end user.

Products which have been tested and certified provide the fitter with security during installation and assembly, and this testing also provides the certainty that the product will perform its function for many years. Furthermore, the final liability for damage or injury caused by a product certified by Electrosuisse lies with the component manufacturer.

AGRO had its laboratory examined by Electrosuisse because it wanted to receive the **TMP (Testing at Manufacturers' Premises) certificate**. The official certification office established that: "The AGRO test laboratory meets the relevant criteria for recognition of test reports according to OD ECS 37, and they meet the requirements of ISO/IEC 17025:2005 (General requirements for the competence of testing and calibration laboratories)." In simple terms, this means that "AGRO AG has the necessary knowledge of standards and test procedures which allow it to test products quickly and safely. The laboratory's test reports are the basis for having Electrosuisse certify a product." What value does this have for customers from the electrical or machinery sectors or automation industry?



Film: Prüflabor



Film: Test Laboratory



Zugprüfung an einer Kabelverschraubung
Tensile test on a cable gland



Massprüfung mittels Messprojektor
Measurement with a projector

Im Mittelpunkt der Prüfung

Das erfolgreiche Bestehen der Prüfung durch Electrosuisse gibt dem Konsumenten die Gewähr, dass der Hersteller eines Produktes über das notwendige normative Wissen verfügt und dass die Prüfeinrichtungen für die Durchführung von Prüfungen nach offiziellen Standards geeignet sind. Geprüft wurden unter anderem die IP-Druckprüfanlage (Schutzart IPX8 bis 10 MPa (100 bar) und die Zugprüfmaschinen bis 2.5 kN (250 kg) für das Prüfen von Kabelverschraubungen, Steckdeckeln, Lampendübeln und anderen Komponenten. Ebenso der Klimaschrank für das Durchführen von Wärmealterungen, die Einrichtung für die Schlagprüfungen, mit der die Widerstandskategorie von Kabelverschraubungen ermittelt wird, und das Testgerät, mit dem die Glühdrahtfestigkeit an Bauteilen nach IEC (650°C / 850°C) geprüft wird.

Alles in allem kommen die Electrosuisse-Experten zu folgendem Schluss: „Die Produkte von AGRO halten, was das Unternehmen verspricht“.

At the focus of testing

By successfully passing the Electrosuisse tests, the manufacturer of a product gives the consumer the assurance that it has the necessary knowledge of standards and test procedures, and that the set-ups for conducting the tests have been judged as being suitable according to official standards. Among the test set-ups evaluated were the ingress protection pressure test system (Protection Class IP X8 up to 10 MPa (100 bar) and tensile testing machines up to 2.5 kN (250 kg) for testing cable glands, socket lids, lamp anchors and other components. Also examined were an environmental chamber for conducting accelerated thermal aging, set-ups for impact tests with which the ruggedness category of cable glands is determined, and the equipment with which the glow wire resistance of components is tested according to IEC (650°C / 850°C). All things considered, the Electrosuisse experts came to the following conclusion: "AGRO products perform just as the company promises."



Oil-Spray Test
Oil-Spray test



Flexing Test
Flexing test

Wir verfügen ebenfalls über eigens konstruierte Prüfeinrichtungen, welche es uns erlauben, **nach der amerikanischen UL514B zu prüfen**. Dies beinhaltet den Oil-Spray, Flexing und pull-out Test sowie die Alterungsprüfung.

Neu können wir im Witness-Verfahren auch Prüfungen (Zertifizierungen) für Kabelverschraubungen, welche für den Einsatz in Explosionsgefährdeten Bereichen zugelassen sind, nach IEC/EN 60079-0 und IEC/EN 60079-1, Zündschutzart „e“ und „d“ durchführen.

All dies erlaubt uns bereits in der Entwicklungsphase die Normvorschriften zu überprüfen und in die weitere Entwicklung mit einfließen zu lassen.

Darüber hinaus sind wir in den wichtigsten nationale Normengremien vertreten, damit wir aktiv die zukünftigen Normen mit gestalten können.

AGRO has expanded its test laboratory with additional test set-ups and can now conduct oil-spray, flexing and pull-out tests as well as accelerated aging tests in accordance with the requirements of the **American UL 514B standard**.

We are able to conduct witness tests on cable glands for use in explosive atmospheres according to IEC/EN 60079-0 for ignition protection type "e" and IEC/EN 50079-1 for ignition protection type "d".

The ability to conduct in-house tests allows us to verify the non-conformity of new products early in the development stage. The development process can thus be faster and more efficient.

AGRO is represented in the most important national standardisation bodies and takes an active role in the design of future standards.

Montageanleitung für Kabelverschraubungen Progress® Assembly instruction cable glands Progress®

Das Unterteil der Kabelverschraubung in das entsprechende Gewinde einschrauben.



Screw the lower part of the cable gland into the corresponding thread.

Oder:

Or:

Das Unterteil der Kabelverschraubung in die vorhandene Eintrittsöffnung im Gehäuse einführen und mittels Gegenmutter befestigen.

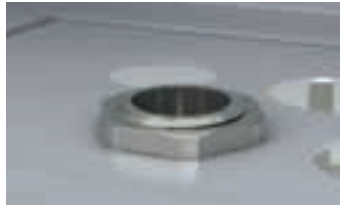

Put the lower part of the cable gland into an existing opening in the enclosure and fix it by means of a lock nut.

Wenn bei zweiteiligen Dichteinsätzen der Kabeldurchmesser das obere Ende des Klemmbereiches der Kabelverschraubung erreicht, muss der innere Teil des Dichteinsatzes entfernt werden.



Remove the inner part of the two-piece sealing insert, in case the cable diameter is close to the upper end of the clamping range of the cable gland.

Kabel, Dichteinsatz und Druckmutter in das Unterteil einführen, Druckmutter von Hand leicht verschrauben.



Insert the cable, sealing insert and the compression nut into the lower part of the cable gland and manually tighten the compression nut.

Druckmutter mit passendem Gabelschlüssel anziehen bis der Dichteinsatz zwischen Druckmutter und Kabel einen kleinen Wulst bildet.



Tighten the compression nut by means of a spanner until the sealing insert forms a small bead between the compression nut and the cable.

Progress® EMV easyCONNECT Messing Progress® EMC easyCONNECT nickel-plated brass

Kontaktfeder aus dem Unterteil der Kabelverschraubung entfernen.



Remove the contact spring from the lower part of the cable gland.

Das Unterteil der Kabelverschraubung in das entsprechende Gewinde einschrauben oder in die vorhandene Eintrittsöffnung im Gehäuse einführen und mittels Gegenmutter befestigen.



Screw the lower part of the cable gland into the corresponding thread or put it into an existing opening in the enclosure and fix it by means of a lock nut.

Kabel abisolieren.



Strip the cable.

Kontaktfeder auf den Kabelschirm aufsetzen.



Clip the contact spring on the shielded cable.

Wenn bei zweiteiligen Dichteinsätzen der Kabeldurchmesser das obere Ende des Klemmbereiches der Kabelverschraubung erreicht, muss der innere Teil des Dichteinsatzes entfernt werden.



Remove the inner part of the two-piece sealing insert, in case the cable diameter is close to the upper end of the clamping range of the cable gland.

Kabel, Kontaktfeder, Dichteinsatz und Druckmutter in das Unterteil einführen, Druckmutter von Hand leicht verschrauben.



Insert cable, contact spring, sealing insert and the compression nut into the lower part of the cable gland and manually tighten the compression nut.

Druckmutter mit passendem Gabelschlüssel anziehen bis der Dichteinsatz zwischen Druckmutter und Kabel einen kleinen Wulst bildet.



Tighten the compression nut by means of a spanner until the sealing insert forms a small bead between the compression nut and the cable.



Über diesen QR Code erhalten Sie den Zugang zum Montagefilm
Progress® EMV easyCONNECT Messing.

By activating this QR Code, you will get access to our installation movie
Progress® EMC easyCONNECT nickel-plated brass.



Montageanleitung

Assembly Instructions

Progress® EMV RAPID

- 1 Komplette Kabelverschraubung (5 Teile) in das vorgesehene Gehäuse einschrauben, ohne die Druckmutter fester anzuziehen.
- 2 Kabelaussenmantel partiell abisolieren oder auf gewünschte Länge zuschneiden.
- 3 Kabel in die Kabelverschraubung einführen, bis der Schirm in der Kontaktscheibe (5) einrastet oder der Kabelmantel an der Scheibe ansteht.
- 4 Druckmutter (1) mit dem Unterteil (4) verschrauben, bis der Dichteinsatz (2) zwischen Druckmutter und Kabel einen kleinen Wulst bildet.

FERTIG!

Die PROGRESS MS EMV RAPID kann durch Ausstossen der Kontaktscheibe (5) auch ohne Weiterführen des Schirms montiert werden. Siehe dazu Montageanleitung der PROGRESS EMV.

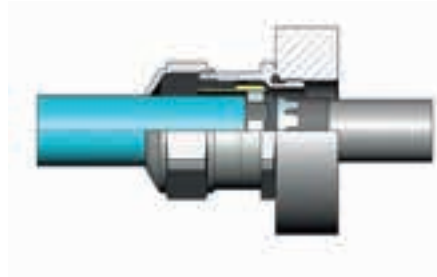
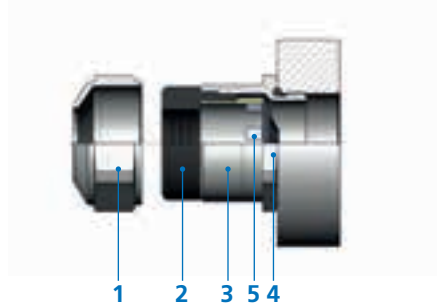

Progress® EMV RAPID

- 1 Screw in the complete cable gland (5 parts) into the intended housing without further tightening the compression nut.
- 2 Partially dismantle the outer cable sleeve or trim to the desired length.
- 3 Feed cable into the cable gland until the shielding snaps into the contact disk (5) or the cable sheath contacts the disc.
- 4 Tighten compression nut (1) to the lower gland part (4) until the sealing insert (2) forms a small ridge between the compression nut and the cable.

FINISHED!

The PROGRESS MS EMV RAPID can also be mounted by extruding the contact disc (5) without extending the shield. See the PROGRESS EMV assembly instructions.

Progress® EMV

- 1 Unterteil (4) der Kabelverschraubung in das vorgesehene Gehäuse einschrauben.
- 2 Druckmutter (1), Dichteinsatz (2) und Kontakthülse (3) über das Kabel ziehen.
- 3 Aussenmantel des Kabels auf die gewünschte Länge zurückschneiden.
- 4 Schirmumflechtung oder Schirmfolie ungefähr auf Kontakthülselänge X zuschneiden.
- 5 Kontakthülse, Dichteinsatz und Druckmutter bis Mantelende vorschieben.
- 6 Schirmgeflecht (6) oder Schirmfolie über Kontakthülse legen und überstehendes Schirmmaterial abschneiden.
- 7 Kabel durch das bereits montierte Unterteil der Kabelverschraubung führen.
- 8 Dichteinsatz und Kontakthülse bündig in das Unterteil stecken.
- 9 Druckmutter mit dem Unterteil verschrauben, bis der Dichteinsatz zwischen Druckmutter und Kabel einen kleinen Wulst bildet.

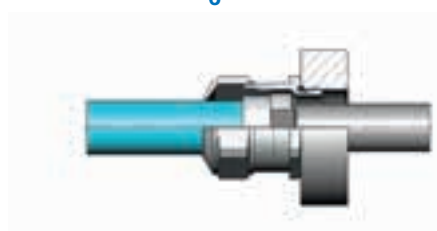
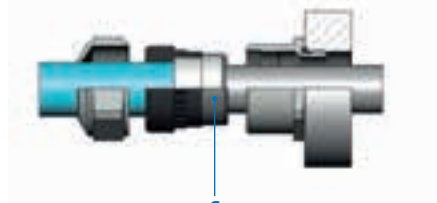
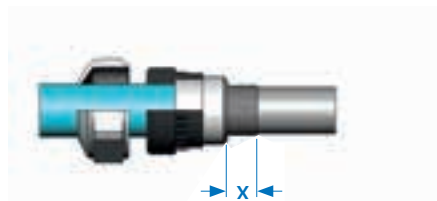
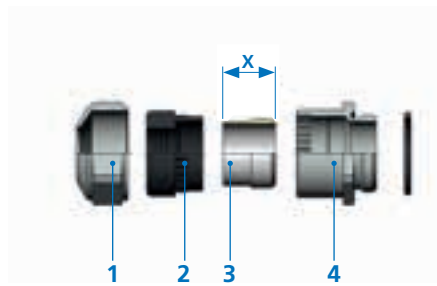

Progress® EMV

- 1 Screw the lower part (4) of the cable gland into the housing.
- 2 Push compression nut (1), sealing insert (2) and contact bushing (3) over the cable.
- 3 Trim outer sheath of the cable to the desired length.
- 4 Trim braided shield or shielding foil to the approximate length of contact bushing X.
- 5 Push contact bushing, sealing insert and compression nut to the end of the sheath.
- 6 Place braided shield (6) or shielding foil over the contact bushing and cut off the protruding shielding material.
- 7 Feed cable through the already mounted lower part of the cable gland.
- 8 Insert sealing insert and contact bushing flush into the lower part.
- 9 Tighten compression nut to the lower part until the sealing insert forms a small ridge between the compression nut and the cable.

Progress® EMV Serie 85

1 Den Kabelmantel und Kabelschirm mit einer Schere sauber auf die gewünschte Länge zurückschneiden, wenn der Kabelschirm nicht weiter geführt werden muss.

Um den Kabelschirm optimal zu schützen, ist es erforderlich, dass der Lieferung beiliegende Kupfer-EMV-Tape (Kupferklebeband 25 mm, Scotch 3M Typ 1181) zu montieren.

2 Das Unterteil (Pos. 5) der Kabelverschraubung in das vorgesehene Gehäuse einschrauben, Druckmutter (Pos. 1), Dichteinsatz (Pos. 2), Zwischenstück (Pos. 4) und Spannzange (Pos. 3) über das Kabel aufschieben. Kabel mit der Spannzange in das Unterteil einführen und positionieren.

3 Zwischenstück mit dem Unterteil verschrauben, bis das Kabel fühlbar geklemmt wird, anschließend gemäss unten stehender Tabelle festziehen.

4 Druckmutter mit dem Zwischenstück (Zwischenstück mit Schlüssel kontern) verschrauben, bis der Dichteinsatz zwischen Druckmutter und Kabel einen kleinen Wulst bildet.

Die Montage sollte nur durch geschultes Fachpersonal durchgeführt werden.

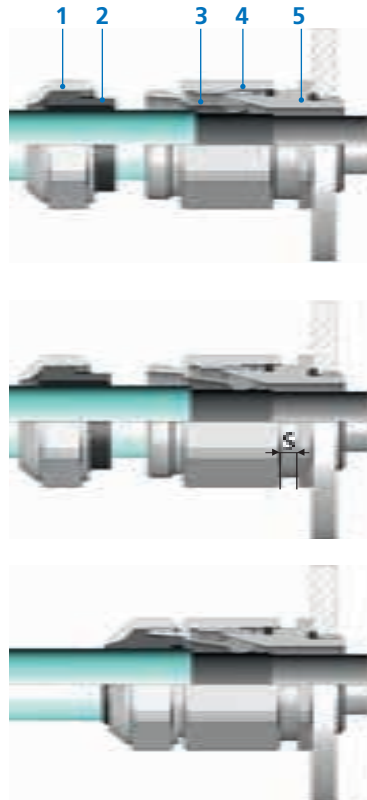

Progress® EMC Series 85

1 Trim the outer cable sheath and cable shield neatly to the desired length using a cutter if the cable shield need not be continued.

To provide the best possible protection for the cable shield, it is necessary to install a copper EMC tape (copper adhesive tape 25 mm wide, Scotch 3M type 1181).

2 Screw the lower section (item 5) of the cable gland into the housing. Push the compression nut (item 1), sealing insert (item 2), adapter (item 4) and collet (item 3) over the cable. Use the collet to introduce and position the cable in the lower section.

3 Screw the adapter onto the lower section until the cable becomes clamped, then tighten according to the table below.

4 Screw the compression nut onto the adapter (tighten the adapter using a spanner) until the sealing insert forms a small ridge between the compression nut and the cable.

Installation should only be carried out by trained experts.

Das Kupfer-Tape muss zwingend gemäss Illustration montiert werden! Klebeschuttfolie vorgängig entfernen.

The copper tape must be fixed according to the illustration! Remove protection film first.



Tape Scotch 3M Typ 1181



Hilfstabelle zur optimalen Schirmkontaktierung

Die Angaben dienen als Arbeitshilfe und ermöglichen eine fachgerechte Montage der Kabelverschraubung Progress EMV Serie 85. Die Richtwerte sind unverbindlich.

Information Table for Optimum Shield Contact

The information is provided as a work instruction and facilitates professional installation of the Progress EMC Series 85 cable gland. The reference values are non-binding.

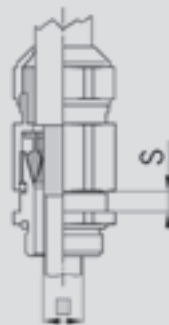

Art-Nr.	Ø Schirm Ø Shield	S mm
1000.17.85.045	3.0 - 4.0	0
	4.0 - 4.5	1.0
1000.17.85.080	4.5 - 6.0	0
	6.0 - 8.0	1.5
1000.17.85.100	7.5 - 10.0	0
1000.20.85.120	7.5 - 10.0	0
	10.0 - 12.0	1.5
1000.20.85.140	10.0 - 12.0	0
	12.0 - 14.0	1.5
1000.25.85.160	10.0 - 13.0	0
	13.0 - 16.0	2.0
1000.25.85.190	14.0 - 16.5	0
	16.5 - 19.0	2.0
1000.32.85.220	14.0 - 18.0	0
	18.0 - 22.0	3.0
1000.32.85.250	21.0 - 23.0	0
	23.0 - 25.0	2.0
1000.40.85.300	21.0 - 25.5	0
	25.5 - 30.0	3.0
1000.50.85.300	29.0 - 33.5	0
	33.5 - 38.0	3.0
1000.63.85.380	29.0 - 33.5	0
	33.5 - 38.0	3.0
1000.63.85.440	35.0 - 39.5	0.5
	39.5 - 44.0	3.0

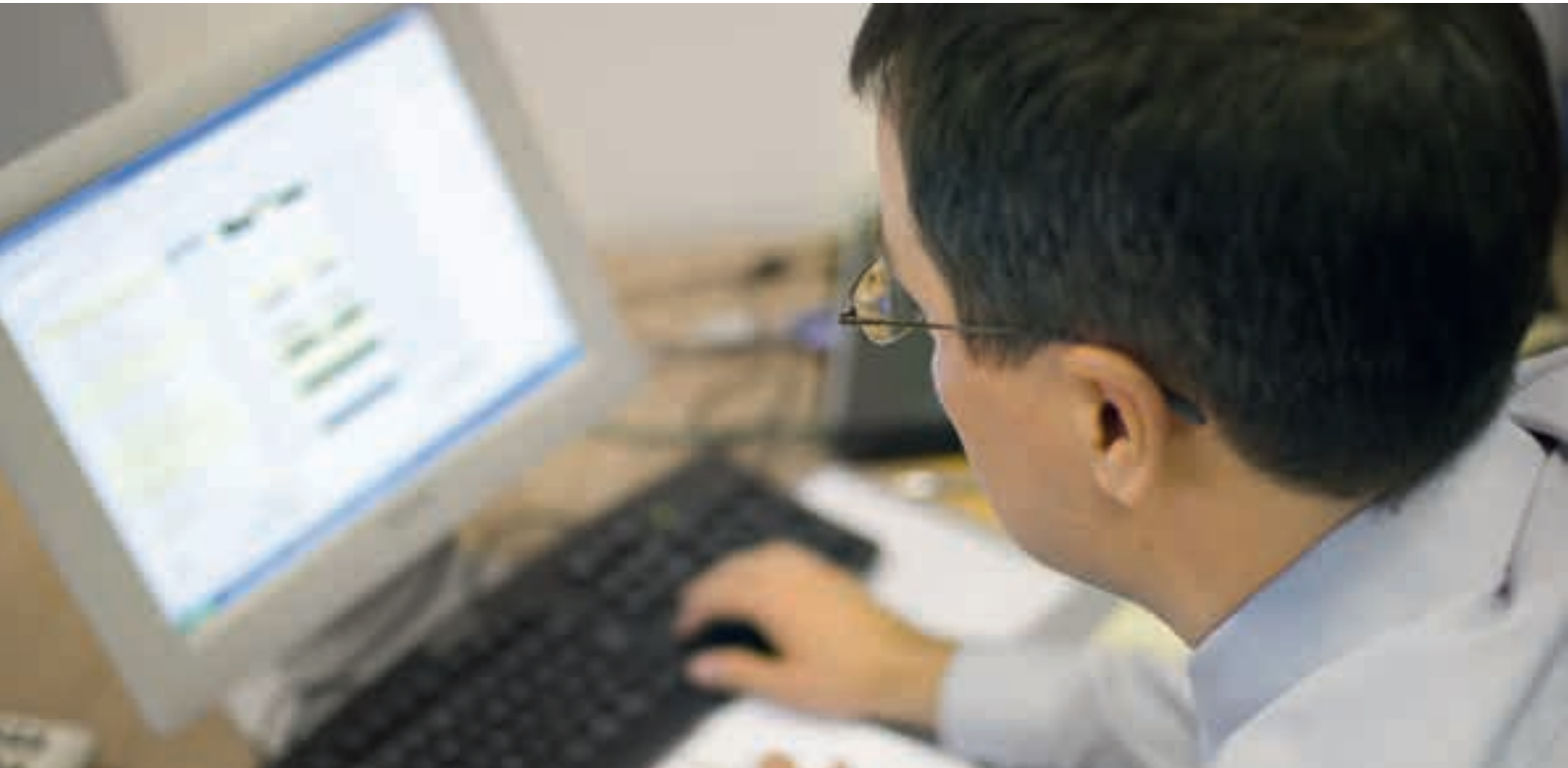

- AGRO online
- Dynamische Produktsuche
- Merkliste
- Produktvergleich
- 3D-Ansicht
- CAD-Download
- Anfragefunktion

Auf unserer Website www.agro.ch bieten wir Ihnen **umfangreiche Informationen**.

Dank der **benutzerfreundlichen Navigation** und der **dynamischen Suchfunktionen** finden Sie die zu Ihrer Anwendung passenden Kabelverschraubungen hier in Sekundenschnelle.

Die **Produktansicht** zeigt alle technischen Daten sowie Zulassungen auf einen Blick. Aus jeder Produktansicht können Sie ein **Produktdatenblatt im PDF-Format** generieren.

Die gewählten Produkte können Sie in einer **Merkliste** speichern, welche eine Vielfalt an Funktionen bietet – z. B. Produktvergleich, Medien-Download oder Anfrageformular.

Die **CAD-Daten** zu allen Kabelverschraubungen sind online hinterlegt. Diese können entweder in einer dynamisch generierten **3D-Ansicht** angezeigt werden oder lassen sich in allen gängigen CAD-Formaten an die eigene E-Mail-Adresse senden.

Wir freuen uns auf Ihren virtuellen Besuch auf unserer Website!

- AGRO online
- Dynamic product searching
- Memo list
- Product comparison
- 3D display
- CAD download
- Inquiry function

You can find **comprehensive information** on our www.agro.ch website.

The **user-friendly navigation** and the **dynamic search functions** ensure that you will find the cable glands you need for your application in just a few seconds.

The **product overview** shows all the technical information and also technical approvals at a glance. You can generate a **pdf-format product data sheet** from every product overview.

In addition, you can store the products you need for your application in a memo list which gives you a wide range of functions, for example product comparisons, media download or an inquiry form.

We have put online the **CAD data** on all cable glands. The data can be displayed as a dynamically-generated 3D format or can be sent to an email address in all standard CAD formats.

We look forward to your virtual visit to our website!



youtube Kabal deutsch

Neu: Produkt-Animationen für Ihr Smartphone

Der QR Code ermöglicht Ihnen einen schnellen und bequemen Zugriff auf unsere informativen Produkt-Animationen mit Ihrem Smartphone. Probieren Sie es aus!

Über diesen QR Code erhalten Sie den Zugang auf eine Präsentation unseres Kabelverschraubungs-Sortimentes.

New: Product animations for your smartphone

The QR codes give you fast, easy access to our informative product animations via your smartphone. Try it - you'll like it!

By activating this QR Code, you will get access to the presentation of our assortment of cable glands.









youtube channel English

1. Ziffer:

Schutzgrad für Berührungs- und Fremdkörperschutz

1st figure:

Degree of protection against touching and foreign matters









IP Prüfungen / Specifications	
IP 0x	Kein Schutz No protection
IP 1x 	Schutz gegen Eindringen von festen Fremdkörpern grösser als 50 mm (unbeabsichtigtes Berühren mit der Hand) Protection against penetration by solid foreign matters larger than 50 mm (accidental touching by hand)
IP 2x 	Schutz gegen Eindringen von festen Fremdkörpern grösser als 12 mm (unbeabsichtigtes Berühren mit den Fingern) Protection against penetration by solid foreign matters larger than 12 mm (touching with fingers)
IP 3x 	Schutz gegen Eindringen von festen Fremdkörpern grösser als 2.5 mm (unbeabsichtigtes Berühren mit Werkzeugen, Drähten usw., dicker als 2.5mm) Protection against penetration by solid foreign matters larger than 2.5 mm (touching with tools, wires etc. larger than 2.5 mm)
IP 4x 	Schutz gegen Eindringen von festen Fremdkörpern grösser als 1 mm (Berühren mit Werkzeugen, Drähten usw., dicker als 1 mm) Protection against penetration by solid foreign matters larger than 1 mm (touching with tools, wires etc. larger than 1 mm)
IP 5x 	Vollständiger Schutz gegen Berühren, Schutz gegen schädliche Staubablagerung – Eindringen von Staub wird nicht vollkommen verhindert Complete protection from being touched. Protection from harmful dust deposits - dust penetration is not completely prevented
IP 6x 	Vollständiger Schutz gegen Berühren, Schutz gegen Eindringen von Staub Complete protection from being touched. Protection against penetration by dust..

2. Ziffer:

Schutzgrad für Wasserschutz

2nd figure:

Degree of protection against water

IP Prüfungen / Specifications	
IP x0	Kein Schutz No protection
IP x1 	Senkrecht fallende Tropfen dürfen keine schädigende Wirkung haben Dripping water (vertically falling drops) shall have no harmful effect
IP x2 	Senkrecht fallende Tropfen dürfen keine schädigende Wirkung haben, wenn das Gehäuse um einen Winkel von bis zu 15° beiderseits der Senkrechten geneigt ist Vertically dripping water shall have no harmful effect when the enclosure is tilted at an angle up to 15° from its normal position
IP x3 	Wasser, das in einem Winkel bis zu 60° beiderseits der Senkrechten gesprüht wird, darf keine schädliche Wirkung haben Water falling as a spray at any angle up to 60° from the vertical shall have no harmful effect
IP x4 	Wasser, das aus jeder Richtung gegen das Gehäuse spritzt, darf keine schädliche Wirkung haben Water splashing against the enclosure from any direction shall have no harmful effect
IP x5 	Wasser, das aus jeder Richtung als Strahl gegen das Gehäuse gerichtet ist, darf keine schädliche Wirkung haben Water projected by a nozzle against enclosure from any direction shall have no harmful effects
IP x6 	Wasser, das aus jeder Richtung als starker Strahl gegen das Gehäuse spritzt, darf keine schädliche Wirkung haben Water projected in powerful jets against the enclosure from any direction shall have no harmful effects
IP x7 	Wasser darf nicht in einer Menge eintreten, die schädliche Wirkungen verursacht, wenn das Gehäuse unter genormten Druck- und Zeitbedingungen zeitweilig in Wasser getaucht ist Ingress of water in harmful quantity shall not be possible when the enclosure is immersed in water under defined conditions of pressure and time
IP x8 	Wasser darf nicht in einer Menge eintreten, die schädliche Wirkungen verursacht, wenn das Gehäuse dauernd unter Wasser getaucht ist unter Bedingungen, die zwischen Hersteller und Anwender vereinbart werden müssen; Die Bedingungen müssen jedoch schwieriger sein als für Kennziffer 7 The equipment is suitable for continuous immersion in water under conditions which shall be specified by the manufacturer The requirements must be more demanding than the ones of code number 7
IP x9K*	Schutz gegen Eindringen von Wasser unter Hochdruck (80-100 bar) mit einer Temperatur bis 80°C (Dampfstrahlreinigung) Protection against the penetration of water during high-pressure (80 - 100 bars), high-temperature wash-down applications (80°C)

*) IP x9K nach DIN 40050-9
IP x9K acc. to DIN 40050-9

1
2
3
4
5
6
7
8
9
10
11
12

Materialübersichtstabelle – Metalle

List of materials – Metals

Produkt Product	Messing vernickelt Nickel-plated brass	Stahl A2 Stainless steel A2	Stahl A4 Stainless steel A4	Aluminium Aluminum
	CuZn39Pb3	X10CrNiS 18 9 DIN 1.4305/AISI 303	X2CrNiMo 18 14 3 DIN 1.4435/AISI 316 L	AlMgSi0.5 DIN 3.3206
Bezeichnung	Kupfer/Zinklegierung Oberfläche galvanisch vernickelt	Rostbeständiger Stahl	Rost- und säurebestän- diger Stahl	Aluminium
Designation	Copper/zinc alloy surface galvanically nickel-plated	Stainless steel	Acid-resistant stainless steel	Aluminum
Korrosionsverhalten Chem. Beständigkeit	Gut beständig in trockener Atmosphäre, Süßwasser, Wasser- dampf, Mineralölen, Kraftstoffen, Kühl-/ Schmierstoffen und vielen organischen Emul- sionen	Gut beständig gegen verdünnte organische und oxidierende Säuren, Laugen, neutrale und alkalische Salzlösungen sowie organische Verbin- dungen	Hat gute Beständig- keit gegen organische Säuren, z.B. Zitronen- Milch-, Ameisen- Wein- und Essigsäure, bei hoher Konzentra- tion und Temperatur. Anorganische Säuren, z.B. Bor-Phosphor- und Salpetersäure sowie schweflige Säure, bei mässiger Konzentration und Temperatur.	Gut beständig in trockener Atmosphäre, Mineralölen, Kraftstoffen
Corrodibility Chemical resistance	High resistance in dry atmosphere, freshwater, against water vapour, mineral oil, motor fuels, cooling and lubricating liquids and against many other organic emulsions	High resistance against diluted organic and oxidizing acids, alkaline solutions, neutral and alkaline saline solutions, as well as against organic compounds	Good resistance against organic acids such as citric, lactic, formic and ethanoic acid as well as acidity of wine in high concentration and temperatu-res. Good resistance against inorganic acids such as boron -phoshoric acid, nitric acid and sulphu- rous acids in moderate concentration and tem- perature	High resistance in dry atmosphere. Resistance against most mineral oils and motor fuels
Bedingt bzw. nicht beständig	Meer-, Brackwasser, feuchte Atmosphären, Säuren, Laugen, Chlori- de, Ammoniak	Anorganische Säuren, Halogene, Chloride und chloridhaltige Lösungen oder Atmosphären	Salzsäure, Halogene, Chloride und chlorid- haltige Lösungen oder Atmosphären	Süss-, Meer-, Brackwas- ser, feuchte Atmosphä- ren, Säuren, Laugen
Non- or partial resi- stance only	Seawater, brackwater, humid atmosphere, acids, alkaline solutions, chlorides, ammonia	Inorganic acids, halogen, chlorides and chlorid containing solutions or atmospheres	Hydrochloric acid, halo- gen, chlorides and chlo- rid containing solutions or atmospheres	Freshwater, sea- and brackwater, humid at- mosphere, acids, alkaline solutions
Witterungsbeständig- keit	Sehr gute Witterungs- und Alterungsbestän- digkeit	Sehr gute Witterungs- und Alterungsbestän- digkeit	Sehr gute Witterungs- und Alterungsbestän- digkeit	Gute Witterungs- und Alterungsbeständigkeit
Weather resistance	Very good weather and non-ageing resistance	Very good weather and non-ageing resistance	Very good weather and non-ageing resistance	Good weather and non- ageing resistance
Thermische Werte dauernd				
Permanent thermal conditions	-40°/+200°	-40°/+400°	-40°/+400°	-40°/+200°
Brennbarkeit	Nicht brennbar	Nicht brennbar	Nicht brennbar	Nicht brennbar
Combustibility	Non-combustible	Non-combustible	Non-combustible	Non-combustible

Bei speziellen Anwendungen bitten wir um Ihre schriftliche Anfrage.

In case of special applications, we kindly ask you to send us your written request.

Technische Änderungen vorbehalten! | Technical modifications are subject to change!

Materialübersichtstabelle – Kunststoffe

List of materials – Elastomeric materials

Produkt / Product Product	Agromid	PA GFK	PA	Polyester
Bezeichnung	Polyamid PA6 GF30, glasfaserverstärkt, schlagzäh, wärmestabilisiert	Polyamid PA6 GF30, glasfaserverstärkt	Polyamid PA6	Polyester PET
Designation	Polyamide PA6 GF30, glass-fiber reinforced, impact resistant, heat-stabilized	Polyamide PA6 GF30, glass-fibre reinforced	Polyamide PA6	Polyester PET
Farbe Colour Couleur	Nach Katalog See catalogue	Nach Katalog See catalogue	Nach Katalog See catalogue	Nach Katalog See catalogue
Korrosionsverhalten Chem. Beständigkeit	Beständig gegen verdünnte organische Säuren, Laugen, wässrige Lösungen von anorganischen Salzen, Mineralöle, Kraftstoffe, Kühl- und Schneideöle			gute Beständigkeit gegen Wasser (bei Raumtemperatur), verdünnte Säuren, neutrale und saure Salze, Alkohol, Ether, Öle, Fette, perchlorierte und aromatische Kohlenwasserstoffe
Corrodibility Chemical resistance	Resistant against organic diluted acids, alkaline solutions, diluted inorganic saline solutions, mineral oils, motor fuels, cooling and cutting oils			good resistance to water (room temperature), diluted acids, neutral and acid salts, alcohol, ether, oils, greases, perchlorinated and aromatic hydrocarbons
Bedingt bzw. nicht beständig	Mineralsäuren, konzentrierte organische Säuren, Ameisensäure, Phenole, Halogene			Alkalien, überhitzten Dampf, Ketone, Phenole, Ester, oxidierende Säuren und Kohlenwasserstoffe, Ammoniak
Non- or partial resistance only	Mineral acids, concentrated organic acids, formic acids, phenols, halogens			Alkalins, superheated steam, ketones, phenols, esters, oxidising acids and hydrocarbons, ammonia
Witterungsbeständigkeit Weather resistance	Gut witterungs- und alterungsbeständig Good weather and non-ageing resistance	Gut witterungsbeständig Good weather resistance	Gut witterungsbeständig Good weather resistance	Gut witterungsbeständig Good weather resistance
Thermische Werte dauernd Permanent thermal conditions	-30°/+120°C	-20°/+100°C	-30°/+100°C	-50°C/+150°C
Brennbarkeit Combustibility	vergleichbar UL 94 HB halogenfrei comparable UL 94 HB halogen free	vergleichbar UL 94 HB halogenfrei comparable UL 94 HB halogen free	UL 94 V-2 halogenfrei UL 94 V-2 halogen free	EN 45545-2 (HL3) halogenfrei EN 45545-2 (HL3) halogen free

Bei speziellen Anwendungen bitten wir um Ihre schriftliche Anfrage.
In case of special applications, we kindly ask you to send us your written request.

Materialübersichtstabelle – Elastomere

List of materials – Elastomeric materials

Produkt / Product	TPE	Spezial/Special TPE	NBR	FPM
Bezeichnung	Thermoplastisches Elastomer	Thermoplastisches Elastomer, Spezial Compound	Acrylnitril-Butadien-Kautschuk	Fluor-Kautschuk
Designation	Thermoplastic elastomere	Thermoplastic elastomere, special compound	Acrylonitrile-butadiene caoutchouc	Fluorine-caoutchouc
Farbe Colour	Schwarz Black	Hellgrau RAL 7035 Light grey RAL 7035	Schwarz BlackBlack	Grün Green
Korrosionsverhalten Chem. Beständigkeit	Beständig gegen verdünnte Säuren und Laugen, wässrige Lösungen von anorganischen Salzen	Gut beständig gegen wässrige Lösungen von anorganischen Salzen, verdünnte Säuren und Laugen, Heisswasser sowie Meerwasser.	Beständig gegen verdünnte Säuren und Laugen, wässrige Lösungen von anorganischen Salzen, Mineralöle, Kraftstoffe, Kühl- und Schneideöle	Beständig gegen die meisten Säuren und Laugen, wässrige Lösungen von anorganischen Salzen, Mineralöle, Kraftstoffe, Kühl- und Schneideöle
Corrodibility Chemical resistance	Resistant against diluted acids and alkaline solutions, against diluted inorganic saline solutions	High resistance against diluted inorganic saline solutions, against diluted acids and alkaline solutions, hotwater as well as seawater.	Resistant against diluted acids and alkaline solutions, against diluted inorganic saline solutions, mineral oils, motor fuels, cooling and cutting oils	Resistant against most acids and alkaline solutions, against diluted inorganic saline solutions, mineral oils, motor fuels, cooling and cutting oils
Bedingt bzw. nicht beständig	Konzentrierte Säuren und Laugen, Lösungsmittel, Kraftstoffe, Mineral-, Kühl- und Schneideöle	Nicht beständig gegen Kraftstoffe, Lösungsmittel, konzentrierte Säuren und Laugen.	Konzentrierte Säuren und Laugen, Lösungsmittel, Ozon	Konzentrierte Laugen
Non- or partial resistance only	Concentrated acids and alkaline solutions, solvents, motor fuels, mineral, cooling and cutting oils	Non resistant to motor fuels, solvents, concentrated acids and alkaline solutions.	Concentrated acids and alkaline solutions, solvents, ozone	Concentrated alkaline solutions
Witterungsbeständigkeit	Gut witterungs-, ozon- und alterungsbeständig	Gut witterungs-, ozon- und alterungsbeständig	Gut witterungsbeständig	Sehr gut witterungs-, ozon- und alterungsbeständig
Weather resistance	Good weather-, ozone and non-ageing resistance	Good weather-, ozone and non-ageing resistance	Good weather resistance	Very good weather-, ozone and non-ageing resistance
Thermische Werte dauernd Permanent thermal conditions	-40°/+100°	-50°C/+105°C	-40°/+100°	-40°/+200°
Brennbarkeit	vergleichbar UL 94 HB halogenfrei	EN 45545-2 / HL3 EN 45545-3 / E30	vergleichbar UL94 HB halogenfrei	vergleichbar UL94 V-2
Combustibility	comparable UL 94 HB halogenfree	EN 45545-2 / HL3 EN 45545-3 / E30	comparable UL 94 HB halogenfree	comparable UL 94 V-2

Bei speziellen Anwendungen bitten wir um Ihre schriftliche Anfrage.
In case of special applications, we kindly ask you to send us your written request.

Produkt / Product	FKM	EPDM	CR
Bezeichnung Designation	Fluor-Kautschuk Fluorine-caoutchouc	Ethylen-Propylen-Terpolymere-Kautschuk Ethylene-Propylene-diene rubber	Chloropren-Kautschuk Chloroprene-caoutchouc
Farbe Colour	blau blue	Nach Katalog See catalogueSee catalogue	Schwarz BlackBlack
Korrosionsverhalten Chem. Beständigkeit	Beständig gegen die meisten Säuren und Laugen, wässrige Lösungen von anorganischen Salzen, Mineralöle, Kraftstoffe, Kühl- und Schneideöle FDA konform	Heisswasser, wässrige Lösungen von anorganischen Salzen, verdünnte Säuren und Laugen	Beständig gegen verdünnte Säuren und Laugen, wässrige Lösungen von anorganischen Salzen, Mineralöle, Kühl- und Schneideöle
Corrodibility Chemical resistance	Resistant against most acids and alkaline solutions, against diluted inorganic saline solutions, mineral oils, motor fuels, cooling and cutting oils. In conformity with FDA requirements.	Hot water, diluted inorganic solutions, diluted acids and alkaline solutions	Resistant against diluted acids and alkaline solutions, against diluted inorganic saline solutions, mineral oils, cooling and cutting oils
Bedingt bzw. nicht beständig Non- or partial resistance only	Konzentrierte Laugen Concentrated alkaline solutions	Mineralöle, Kraft- und Treibstoffe, konzentrierte Säuren und Laugen, Ester Mineral oils, motor fuels, concentrated acids and alkaline solutions, ester	Konzentrierte Säuren und Laugen, Kraftstoffe, Lösungsmittel, Heisswasser, Ozon Concentrated acids and alkaline solutions, motor fuels, solvents, hotwater, ozone
Witterungsbeständigkeit Weather resistance	Sehr gut witterungs-, ozon- und alterungsbeständig Very good weather-, ozone and non-ageing resistance	Gut witterungs-, ozon- und alterungsbeständig Good weather, ozone and non-ageing resistance	Gut witterungsbeständig Good weather resistance
Thermische Werte dauernd Permanent thermal conditions	-40°C/+200°C	-40°/+110°C	-30°/+100°
Brennbarkeit Combustibility	vergleichbar UL94 V-2 comparable UL 94 V-2	vergleichbar UL 94 HB halogenfrei comparable UL 94 HB halogen free	vergleichbar UL94 HB comparable UL 94 HB

Bei speziellen Anwendungen bitten wir um Ihre schriftliche Anfrage.
In case of special applications, we kindly ask you to send us your written request.

Masse für Gewinde und Bohrlöcher

Dimensions of threads and drilled holes

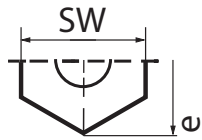



Ermittlung der Eckmasse „e“

6-Kant:
 $e = 1.155 \times SW$ (Schlüsselweite)

Determinatin of the width across corners „e“

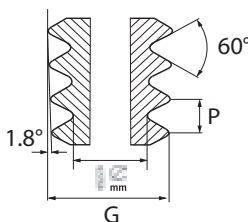
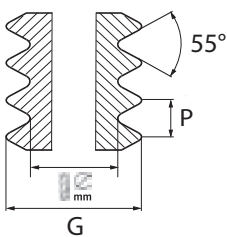
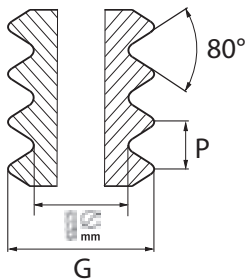
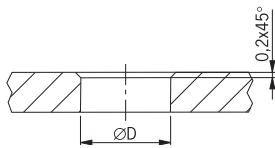
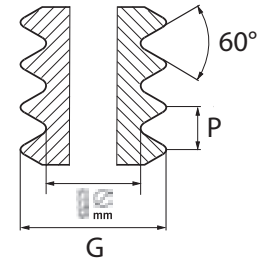
hexagon:
 $e = 1.155 \times SW$ (opening of the spanner)



	G	Steigung Pitch P	 mm	ØD mm
Metrisches Gewinde Metric thread				
M6x1.0 ¹⁾	6.00	1.00	5.00	6.0
M6x0.75 ²⁾	6.00	0.75	5.25	6.0
M8x1.25 ¹⁾	8.00	1.25	6.75	8.0
M8x1.0 ²⁾	8.00	1.00	7.00	8.0
M10x1.5 ¹⁾	10.00	1.50	8.50	10.0
M10x1.0 ²⁾	10.00	1.00	9.00	10.0
M12x1.5	12.00	1.50	10.50	12.0
M16x1.5	16.00	1.50	14.50	16.0
M20x1.5	20.00	1.50	18.50	20.0
M25x1.5	25.00	1.50	23.50	25.0
M32x1.5	32.00	1.50	30.50	32.0
M40x1.5	40.00	1.50	38.50	40.2
M50x1.5	50.00	1.50	48.50	50.2
M63x1.5	63.00	1.50	61.50	63.2
M75x1.5	75.00	1.50	73.50	75.2
M80x1.5	80.00	1.50	78.50	80.2
M85x2.0	85.00	2.00	83.00	85.2
M95x2.0	95.00	2.00	93.00	95.2
M100x3.0	100.00	3.00	97.00	100.2
M105x3.0	105.00	3.00	102.00	105.2
M115x3.0	115.00	3.00	112.00	115.2
Pg - Gewinde Thread Pg				
Pg 7	12.50	1.27	11.40	12.6
Pg 9	15.20	1.41	14.00	15.3
Pg 11	18.60	1.41	17.25	18.7
Pg 13	20.40	1.41	19.00	20.5
Pg 16	22.50	1.41	21.25	22.6
Pg 21	28.30	1.58	26.75	28.4
Pg 29	37.00	1.58	35.50	37.2
Pg 36	47.00	1.58	45.50	47.2
Pg 42	54.00	1.58	52.50	54.2
Pg 48	59.30	1.58	57.80	59.5
Gasrohr-Gewinde Gas-pipe thread				
G 1/4"	13.15	1.33	11.60	13.3
G 3/8"	16.66	1.33	15.00	16.8
G 1/2"	20.95	1.81	19.00	21.0
G 5/8"	22.91	1.81	21.00	23.0
G 3/4"	26.44	1.81	24.60	26.5
G 1"	33.25	2.30	30.50	33.5
G 1 1/4"	41.91	2.30	39.50	42.2
G 1 1/2"	47.80	2.30	45.00	48.0
G 2"	59.61	2.30	57.00	60.0
G 2 1/2"	75.18	2.30	72.50	75.5
G 3"	87.88	2.30	84.50	88.0
G 4"	113.03	2.30	110.50	113.5
G 5"	138.43	2.30	136.00	139.0
NPT-Gewinde Filetage NPT				
NPT 1/8"	10.29	0.94	8.43	
NPT 1/7"	13.72	1.41	11.13	
NPT 3/8"	17.14	1.41	14.27	
NPT 1/2"	21.34	1.81	17.86	
NPT 3/4"	26.67	1.81	23.28	
NPT 1"	33.40	2.20	28.98	
NPT 1 1/4"	42.16	2.20	37.69	
NPT 1 1/2"	48.26	2.20	43.66	
NPT 2"	60.32	2.20	55.58	

Art.-Nr. Art. No.	Seite Page	Art.-Nr. Art. No.	Seite Page	Art.-Nr. Art. No.	Seite Page	Art.-Nr. Art. No.	Seite Page	Art.-Nr. Art. No.	Seite Page
10...		1000.11.085	23	1000.17.85.100	100	1000.2NPT.400	28	1000.48.30	38
1000.06.025	17	1000.11.120	23	1000.17.91.105	30	1000.2NPT.460	28	1000.48.30.03	225
1000.06.030	17	1000.11.20.30	38	1000.17.92	30	1000.2NPT.520	28	1000.48.30.91	39
1000.06.035	17	1000.11.20.30.91	39	1000.17.98.30.03	225	1000.3/4G	29	1000.48.370	23
1000.06.30	38	1000.11.30	38	1000.1G	29	1000.3/4NPT	28	1000.48.430	23
1000.06.30.03	225	1000.11.30.03	225	1000.1NPT	28	1000.3/4NPT.125	28	1000.48.490	23
1000.06.30.91	39	1000.11.30.91	39	1000.1NPT.170	28	1000.3/4NPT.160	28	1000.48.91.490	32
1000.06.91.025	30	1000.11.85.080	101	1000.1NPT.210	28	1000.3/4NPT.205	28	1000.48.92	32
1000.06.91.030	30	1000.11.85.120	101	1000.1NPT.255	28	1000.3/8G	29	1000.48.98.30.03	225
1000.06.91.035	30	1000.11.91.120	32	1000.20	18	1000.3/8NPT	28	1000.50	18
1000.06.98.30.03	225	1000.11.92	32	1000.20.080	17	1000.3/8NPT.045	28	1000.50.00.08	226
1000.07.050	23	1000.11.98.30.03	225	1000.20.110	17	1000.3/8NPT.060	28	1000.50.30	38
1000.07.065	23	1000.11/2G	29	1000.20.150	17	1000.3/8NPT.080	28	1000.50.30.03	225
1000.07.080	23	1000.11/2NPT	28	1000.20.30	38	1000.3/8NPT.105	28	1000.50.30.91	39
1000.07.30	38	1000.11/2NPT.330	28	1000.20.30.03	225	1000.32	18	1000.50.330	17
1000.07.30.91	39	1000.11/2NPT.370	28	1000.20.30.91	39	1000.32.170	17	1000.50.370	17
1000.07.91.050	32	1000.11/2NPT.410	28	1000.20.85.120	100	1000.32.210	17	1000.50.420	17
1000.07.91.065	32	1000.11/4NPT	28	1000.20.85.140	100	1000.32.255	17	1000.50.85.380	100
1000.07.91.080	32	1000.11/4NPT.240	28	1000.20.91.150	30	1000.32.30	38	1000.50.91.420	30
1000.08.035	17	1000.11/4NPT.285	28	1000.20.92	30	1000.32.30.03	225	1000.50.92	30
1000.08.050	17	1000.11/4NPT.330	28	1000.20.98.30.03	225	1000.32.30.91	39	1000.50.98.30.03	225
1000.08.30	38	1000.115.30.03	225	1000.21	24	1000.32.85.220	100	1000.63	18
1000.08.30.03	225	1000.115.950	17	1000.21.125	23	1000.32.85.250	100	1000.63.00.08	226
1000.08.30.91	39	1000.12.050	17	1000.21.160	23	1000.32.91.255	30	1000.63.30	38
1000.08.91.035	30	1000.12.065	17	1000.21.205	23	1000.32.92	30	1000.63.30.03	225
1000.08.91.050	30	1000.12.080	17	1000.21.30	38	1000.32.98.30.03	225	1000.63.30.91	39
1000.08.98.30.03	225	1000.12.30	38	1000.21.30.91	39	1000.36	24	1000.63.400	17
1000.085.30.03	225	1000.12.30.03	225	1000.21.32.30	38	1000.36.260	23	1000.63.460	17
1000.09	24	1000.12.30.91	39	1000.21.32.30.91	39	1000.36.30	38	1000.63.520	17
1000.09.00.08	226	1000.12.91.050	30	1000.21.85.160	101	1000.36.30.03	225	1000.63.85.380	100
1000.09.045	23	1000.12.91.065	30	1000.21.85.190	101	1000.36.30.91	39	1000.63.85.440	100
1000.09.060	23	1000.12.91.080	30	1000.21.91.205	32	1000.36.305	23	1000.63.91.520	30
1000.09.080	23	1000.12.98.30.03	225	1000.21.92	32	1000.36.350	23	1000.63.92	30
1000.09.105	23	1000.13	24	1000.21/2G.500	29	1000.36.50.30	38	1000.63.98.30.03	225
1000.09.30	38	1000.13.080	23	1000.21/2G.560	29	1000.36.50.30.91	39	1000.75	18
1000.09.30.91	39	1000.13.110	23	1000.25	18	1000.36.91.350	32	1000.75.00.08	226
1000.09.91.105	32	1000.13.150	23	1000.25.125	17	1000.36.92	32	1000.75.30.03	225
1000.09.92	32	1000.13.30	38	1000.25.160	17	1000.36.98.30.03	225	1000.75.500	17
1000.095.30.03	225	1000.13.30.91	39	1000.25.205	17	1000.3G.630	29	1000.75.560	17
1000.1/2G	29	1000.13.91.150	32	1000.25.30	38	1000.3G.700	29	1000.75.630	17
1000.1/2NPT	28	1000.13.92	32	1000.25.30.03	225	1000.40	18	1000.85.700	17
1000.1/2NPT.080	28	1000.16	24	1000.25.30.91	39	1000.40.00.08	226	1000.95.750	17
1000.1/2NPT.110	28	1000.16.080	23	1000.25.85.160	100	1000.40.240	17	1000.95.800	17
1000.1/2NPT.150	28	1000.16.110	23	1000.25.85.190	100	1000.40.285	17	1005.00.08	226
1000.1/4NPT.050	28	1000.16.150	23	1000.25.91.205	30	1000.40.30	38	1006.00.08	226
1000.1/4NPT.065	28	1000.16.25.30	38	1000.25.92	30	1000.40.30.03	225	1006.00.16	227
1000.1/4NPT.080	28	1000.16.25.30.91	39	1000.25.98.30.03	225	1000.40.30.91	39	1006.06.08	226
1000.1/8NPT.040	28	1000.16.30	38	1000.29	24	1000.40.330	17	1007.00.08	226
1000.1/8NPT.060	28	1000.16.30.91	39	1000.29.190	23	1000.40.85.300	100	1007.00.16	227
1000.10.040	17	1000.16.85.120	101	1000.29.230	23	1000.40.91.330	30	1007.45.16	228
1000.10.060	17	1000.16.85.150	101	1000.29.275	23	1000.40.92	30	1007.52	45
1000.10.30	38	1000.16.91.150	32	1000.29.30	38	1000.40.98.30.03	225	1007.80.10	103
1000.10.30.03	225	1000.16.92	32	1000.29.30.03	225	1000.42	24	1008.00.16	227
1000.10.30.91	39	1000.17	18	1000.29.30.91	39	1000.42.00.08	226	1008.52	45
1000.10.91.040	30	1000.17.045	17	1000.29.40.30	38	1000.42.30	38	1009.00.16	227
1000.10.91.060	30	1000.17.060	17	1000.29.40.30.91	39	1000.42.30.91	39	1009.45.16	228
1000.10.98.30.03	225	1000.17.080	17	1000.29.85.220	101	1000.42.330	23	1009.52	45
1000.100.30.03	225	1000.17.105	17	1000.29.85.250	101	1000.42.370	23	1009.80.10	103
1000.100.850	17	1000.17.30	38	1000.29.91.275	32	1000.42.420	23	1010.00.16	227
1000.105.30.03	225	1000.17.30.03	225	1000.29.92	32	1000.42.91.420	32	1010.52	45
1000.105.900	17	1000.17.30.91	39	1000.29.98.30.03	225	1000.42.92	32	1011.00.08	226
1000.11	24	1000.17.85.045	100	1000.2G	29	1000.48	24	1011.00.16	227
1000.11.055	23	1000.17.85.080	100	1000.2NPT	28	1000.48.00.08	226	1011.00.19	229

1
2
3
4
5
6
7
8
9
10
11

Art.-Nr. Art. No.	Seite Page	Art.-Nr. Art. No.	Seite Page	Art.-Nr. Art. No.	Seite Page	Art.-Nr. Art. No.	Seite Page	Art.-Nr. Art. No.	Seite Page
1011.45.16	228	1040.20.96.30.080	69	1060.06.030	16	1060.20.110	16	1080.08.52.040	98
1011.52	45	1040.20.96.30.105	69	1060.07.050	22	1060.20.145	16	1080.09.080	94
1011.80.10	103	1040.20.96.70.080	69	1060.07.065	22	1060.20.52	46	1080.09.100	94
1012.00.16	227	1040.20.96.70.105	69	1060.07.075	22	1060.20.52.080	46	1080.09.52.080	99
1012.00.19	229	1040.25.40.110	68	1060.07.52.050	47	1060.20.52.110	46	1080.09.52.100	99
1012.45.16	228	1040.25.40.150	68	1060.07.52.065	47	1060.20.52.145	46	1080.09.91.080	97
1012.52	45	1040.25.96.30.110	69	1060.07.52.075	47	1060.21	22	1080.09.91.100	97
1013.00.16	227	1040.25.96.30.150	69	1060.08.030	16	1060.21.125	22	1080.10.040	92
1013.00.22.08	226	1040.25.96.70.110	69	1060.08.040	16	1060.21.160	22	1080.10.060	92
1013.45.16	228	1040.25.96.70.150	69	1060.08.52.030	46	1060.21.190	22	1080.10.52.040	98
1013.51	45	1040.32.40.160	68	1060.08.52.040	46	1060.21.52	47	1080.10.52.060	98
1013.52	45	1040.32.40.205	68	1060.09	22	1060.21.52.125	47	1080.10.91.040	96
1016.00.08	226	1040.32.96.30.160	69	1060.09.060	22	1060.21.52.160	47	1080.10.91.060	96
1016.00.16	227	1040.32.96.30.205	69	1060.09.080	22	1060.21.52.190	47	1080.11.085	94
1016.00.25.08	226	1040.32.96.70.160	69	1060.09.105	22	1060.25	16	1080.11.120	94
1016.45.16	228	1040.32.96.70.205	69	1060.09.52	47	1060.25.125	16	1080.11.52.080	99
1016.51	45	1040.45.16	228	1060.09.52.060	47	1060.25.160	16	1080.11.52.100	99
1016.52	45	1040.80.10	103	1060.09.52.080	47	1060.25.190	16	1080.11.91.085	97
1016.80.10	103	1042.00.16	227	1060.09.52.105	47	1060.25.52	46	1080.11.91.120	97
1017.00.16	227	1045.07.050	179	1060.10.040	16	1060.25.52.125	46	1080.12.060	92
1017.00.19	229	1045.07.070	179	1060.10.060	16	1060.25.52.160	46	1080.12.075	92
1017.45.16	228	1045.09.060	179	1060.10.52.040	46	1060.25.52.190	46	1080.12.52.060	98
1017.52	45	1045.09.100	179	1060.10.52.060	46	1060.29	22	1080.12.52.075	98
1017.80.10	103	1045.11.080	179	1060.11	22	1060.29.230	22	1080.12.91.060	96
1020.00.19	229	1045.11.130	179	1060.11.055	22	1060.29.275	22	1080.12.91.075	96
1020.45.16	228	1045.12.050	178	1060.11.085	22	1060.32	16	1080.13.110	94
1020.51	45	1045.12.070	178	1060.11.120	22	1060.32.210	16	1080.13.140	94
1020.52	45	1045.13.080	179	1060.11.52	47	1060.32.255	16	1080.13.52.110	99
1020.80.10	103	1045.13.130	179	1060.11.52.060	47	1060.32.52	46	1080.13.52.140	99
1021.00.16	227	1045.16.080	179	1060.11.52.080	47	1060.32.52.210	46	1080.13.91.110	97
1021.00.30.08	226	1045.16.110	179	1060.11.52.105	47	1060.32.52.245	46	1080.13.91.140	97
1021.45.16	228	1045.16.130	179	1060.12.050	16	1060.36	22	1080.16.110	94
1021.51	45	1045.16.170	179	1060.12.065	16	1060.36.305	22	1080.16.140	94
1021.80.10	103	1045.17.060	178	1060.12.075	16	1060.36.350	22	1080.16.52.110	99
1025.00.16	227	1045.17.100	178	1060.12.52.050	46	1060.40	16	1080.16.52.140	99
1025.00.19	229	1045.20.080	178	1060.12.52.065	46	1060.40.285	16	1080.16.91.110	97
1025.45.16	228	1045.20.130	178	1060.12.52.075	46	1060.40.330	16	1080.16.91.140	97
1025.52	45	1045.21.150	179	1060.13	22	1060.42	22	1080.17.080	92
1025.80.10	103	1045.21.210	179	1060.13.080	22	1060.42.370	22	1080.17.100	92
1029.00.08	226	1045.25.110	178	1060.13.110	22	1060.42.420	22	1080.17.52.080	98
1029.00.16	227	1045.25.170	178	1060.13.145	22	1060.48	22	1080.17.52.100	98
1029.00.19	229	1045.29.230	179	1060.13.52	47	1060.48.430	22	1080.17.91.080	96
1029.45.16	228	1045.29.280	179	1060.13.52.080	47	1060.48.490	22	1080.17.91.100	96
1029.80.10	103	1045.32.150	178	1060.13.52.110	47	1060.50	16	1080.20.110	92
1032.00.16	227	1045.32.210	178	1060.13.52.145	47	1060.50.370	16	1080.20.140	92
1032.00.19	229	1045.36.290	179	1060.16	22	1060.50.420	16	1080.20.52.110	98
1032.45.16	228	1045.36.350	179	1060.16.080	22	1060.63	16	1080.20.52.140	98
1032.80.10	103	1045.40.230	178	1060.16.110	22	1060.63.460	16	1080.20.91.110	96
1036.00.08	226	1045.40.280	178	1060.16.145	22	1060.63.520	16	1080.20.91.140	96
1036.00.16	227	1045.42.290	179	1060.16.52	47	1060.75	16	1080.21.160	94
1036.00.19	229	1045.42.350	179	1060.16.52.080	47	1060.75.560	16	1080.21.190	94
1036.45.16	228	1045.48.390	179	1060.16.52.110	47	1060.75.630	16	1080.21.52.160	99
1036.80.10	103	1045.48.480	179	1060.16.52.145	47	1063.00.16	227	1080.21.52.190	99
1040.00.16	227	1045.50.290	178	1060.17	16	1063.00.19	229	1080.21.91.160	97
1040.00.19	229	1045.50.350	178	1060.17.060	16	1063.45.16	228	1080.21.91.190	97
1040.17.40.065	68	1045.63.390	178	1060.17.080	16	1063.80.10	103	1080.25.160	92
1040.17.40.080	68	1045.63.480	178	1060.17.105	16	1080.07.060	94	1080.25.190	92
1040.17.96.30.065	69	1048.00.16	227	1060.17.52	46	1080.07.075	94	1080.25.52.160	98
1040.17.96.30.080	69	1050.00.16	227	1060.17.52.060	46	1080.07.52.060	99	1080.25.52.190	98
1040.17.96.70.065	69	1050.00.19	229	1060.17.52.080	46	1080.07.52.075	99	1080.25.91.160	96
1040.17.96.70.080	69	1050.45.16	228	1060.17.52.105	46	1080.08.035	92	1080.25.91.190	96
1040.20.40.080	68	1050.80.10	103	1060.20	16	1080.08.040	92	1080.29.230	94
1040.20.40.105	68	1060.06.025	16	1060.20.080	16	1080.08.52.035	98	1080.29.255	94

Art.-Nr. Art. No.	Seite Page	Art.-Nr. Art. No.	Seite Page	Art.-Nr. Art. No.	Seite Page	Art.-Nr. Art. No.	Seite Page	Art.-Nr. Art. No.	Seite Page
1080.29.91.230	97	1100.07.080	26	1100.12.91.050	31	1100.20.98	64	1100.36.96.350	63
1080.29.91.255	97	1100.07.91.050	33	1100.12.91.065	31	1100.20.98.150	64	1100.36.98	65
1080.32.210	92	1100.07.91.065	33	1100.12.91.080	31	1100.21	27	1100.36.98.350	65
1080.32.250	92	1100.07.91.080	33	1100.12.94.050	60	1100.21.125	26	1100.40	21
1080.32.52.210	98	1100.07.94.050	61	1100.12.94.065	60	1100.21.160	26	1100.40.240	20
1080.32.52.245	98	1100.07.94.065	61	1100.12.94.080	60	1100.21.205	26	1100.40.285	20
1080.32.91.210	96	1100.07.94.080	61	1100.12.96.050	62	1100.21.50	43	1100.40.330	20
1080.32.91.250	96	1100.07.96.050	63	1100.12.96.065	62	1100.21.91.205	33	1100.40.50	43
1080.36.305	94	1100.07.96.065	63	1100.12.96.080	62	1100.21.92	33	1100.40.91.330	31
1080.36.350	94	1100.07.96.080	63	1100.12.98.050	64	1100.21.94	61	1100.40.92	31
1080.40.285	92	1100.07.98.050	65	1100.12.98.065	64	1100.21.94.205	61	1100.40.94	60
1080.40.320	92	1100.07.98.065	65	1100.12.98.080	64	1100.21.96	63	1100.40.94.330	60
1080.42.370	94	1100.07.98.080	65	1100.13	27	1100.21.96.205	63	1100.40.96	62
1080.42.410	94	1100.08.035	20	1100.13.080	26	1100.21.98	65	1100.40.96.330	62
1080.48.430	94	1100.08.050	20	1100.13.110	26	1100.21.98.205	65	1100.40.98	64
1080.48.465	94	1100.08.91.035	31	1100.13.150	26	1100.25	21	1100.40.98.08	226
1080.50.370	92	1100.08.91.050	31	1100.13.50	43	1100.25.125	20	1100.40.98.330	64
1080.50.410	92	1100.08.94.035	60	1100.13.91.150	33	1100.25.160	20	1100.42	27
1080.63.460	92	1100.08.94.050	60	1100.13.92	33	1100.25.205	20	1100.42.330	26
1080.63.500	92	1100.08.96.035	62	1100.13.94	61	1100.25.50	43	1100.42.370	26
1080.75.560	92	1100.08.96.050	62	1100.13.94.150	61	1100.25.91.205	31	1100.42.420	26
1080.80.650	92	1100.08.98.035	64	1100.13.96	63	1100.25.92	31	1100.42.91.420	33
1080.85.700	92	1100.08.98.050	64	1100.13.96.150	63	1100.25.94	60	1100.42.92	33
1080.95.750	92	1100.09	27	1100.13.98	65	1100.25.94.205	60	1100.42.94	61
1081.07.060	91	1100.09.045	26	1100.13.98.150	65	1100.25.96	62	1100.42.94.420	61
1081.07.075	91	1100.09.060	26	1100.16	27	1100.25.96.205	62	1100.42.96	63
1081.09.080	91	1100.09.080	26	1100.16.080	26	1100.25.98	64	1100.42.96.420	63
1081.09.100	91	1100.09.105	26	1100.16.110	26	1100.25.98.205	64	1100.42.98	65
1081.11.085	91	1100.09.91.105	33	1100.16.150	26	1100.29	27	1100.42.98.08	226
1081.11.120	91	1100.09.92	33	1100.16.50	43	1100.29.190	26	1100.42.98.420	65
1081.12.060	90	1100.09.94	61	1100.16.91.150	33	1100.29.230	26	1100.48	27
1081.12.075	90	1100.09.94.105	61	1100.16.92	33	1100.29.275	26	1100.48.370	26
1081.13.110	91	1100.09.96	63	1100.16.94	61	1100.29.50	43	1100.48.430	26
1081.13.140	91	1100.09.96.105	63	1100.16.94.150	61	1100.29.91.275	33	1100.48.490	26
1081.16.110	91	1100.09.98	65	1100.16.96	63	1100.29.92	33	1100.48.91.490	33
1081.16.140	91	1100.09.98.08	226	1100.16.96.150	63	1100.29.94	61	1100.48.92	33
1081.17.080	90	1100.09.98.105	65	1100.16.98	65	1100.29.94.275	61	1100.48.94	61
1081.17.100	90	1100.10.040	20	1100.16.98.150	65	1100.29.96	63	1100.48.94.490	61
1081.20.110	90	1100.10.060	20	1100.17	21	1100.29.96.275	63	1100.48.96	63
1081.20.140	90	1100.10.91.040	31	1100.17.045	20	1100.29.98	65	1100.48.96.490	63
1081.21.160	91	1100.10.91.060	31	1100.17.060	20	1100.29.98.275	65	1100.48.98	65
1081.21.190	91	1100.10.94.040	60	1100.17.080	20	1100.32	21	1100.48.98.08	226
1081.25.160	90	1100.10.94.060	60	1100.17.105	20	1100.32.170	20	1100.48.98.490	65
1081.25.190	90	1100.10.96.040	62	1100.17.50	43	1100.32.210	20	1100.50	21
1081.29.230	91	1100.10.96.060	62	1100.17.91.105	31	1100.32.255	20	1100.50.330	20
1081.29.255	91	1100.10.98.040	64	1100.17.92	31	1100.32.50	43	1100.50.370	20
1081.32.210	90	1100.10.98.060	64	1100.17.94	60	1100.32.91.255	31	1100.50.420	20
1081.32.250	90	1100.11	27	1100.17.94.105	60	1100.32.92	31	1100.50.91.420	31
1083.12.050	89	1100.11.055	26	1100.17.96	62	1100.32.94	60	1100.50.92	31
1083.12.065	89	1100.11.085	26	1100.17.96.105	62	1100.32.94.255	60	1100.50.94	60
1083.17	89	1100.11.120	26	1100.17.98	64	1100.32.96	62	1100.50.94.420	60
1083.20	89	1100.11.50	43	1100.17.98.105	64	1100.32.96.255	62	1100.50.96	62
1083.25	89	1100.11.91.120	33	1100.20	21	1100.32.98	64	1100.50.96.420	62
1083.32	89	1100.11.92	33	1100.20.080	20	1100.32.98.255	64	1100.50.98	64
11...		1100.11.94	61	1100.20.110	20	1100.36	27	1100.50.98.08	226
1100.06.025	20	1100.11.94.120	61	1100.20.150	20	1100.36.260	26	1100.50.98.420	64
1100.06.030	20	1100.11.96	63	1100.20.50	43	1100.36.305	26	1100.63	21
1100.06.035	20	1100.11.96.120	63	1100.20.91.150	31	1100.36.350	26	1100.63.400	20
1100.06.91.025	31	1100.11.98	65	1100.20.92	31	1100.36.91.350	33	1100.63.460	20
1100.06.91.030	31	1100.11.98.120	65	1100.20.94	60	1100.36.92	33	1100.63.520	20
1100.06.91.035	31	1100.12.050	20	1100.20.94.150	60	1100.36.94	61	1100.63.91.520	31
1100.07.050	26	1100.12.065	20	1100.20.96	62	1100.36.94.350	61	1100.63.92	31
1100.07.065	26	1100.12.080	20	1100.20.96.150	62	1100.36.96	63	1100.63.94	60

1
2
3
4
5
6
7
8
9
10
11
12

Art.-Nr. Art. No.	Seite Page	Art.-Nr. Art. No.	Seite Page	Art.-Nr. Art. No.	Seite Page	Art.-Nr. Art. No.	Seite Page	Art.-Nr. Art. No.	Seite Page
1100.63.94.520	60	1160.21.190	25	1165.80.32.210	160	1180.29.255	95	1300.29.265.090	42
1100.63.96	62	1160.25	19	1165.80.32.250	160	1180.29.91.230	97	1300.29.280.060	42
1100.63.96.520	62	1160.25.190	19	1165.80.36.305	161	1180.29.91.255	97	1300.29.300.100	42
1100.63.98	64	1160.29	25	1165.80.36.350	161	1180.32.210	93	1300.29.320.090	42
1100.63.98.08	226	1160.29.275	25	1165.80.40.285	160	1180.32.250	93	1300.29.330.065	42
1100.63.98.520	64	1160.32	19	1165.80.40.320	160	1180.32.91.210	96	1300.32.220.060	40
1100.75	21	1160.32.255	19	1165.80.48.430	161	1180.32.91.250	96	1300.32.220.080	40
1100.75.500	20	1160.36	25	1165.80.48.465	161	1180.36.305	95	1300.40.260.070	40
1100.75.560	20	1160.36.350	25	1165.80.50.370	160	1180.36.350	95	1300.40.265.090	40
1100.75.630	20	1160.40	19	1165.80.50.410	160	1180.40.285	93	1300.40.280.060	40
1100.75.98.08	226	1160.40.330	19	1165.80.63.460	160	1180.40.320	93	1300.40.300.100	40
1105.98.08	226	1160.42	25	1165.80.63.500	160	1180.42.370	95	1300.40.320.090	40
1106.06.98.08	226	1160.42.420	25	1165.84.20.15	162	1180.42.410	95	1300.40.330.065	40
1106.98.08	226	1160.48	25	1165.84.25.21	162	1180.48.430	95	1300.42.340.115	42
1107.98.08	226	1160.48.490	25	1165.84.32.34	162	1180.48.465	95	1300.42.370.070	42
1111.98.08	226	1160.50	19	1165.84.40.34	162	1180.50.370	93	1300.42.400.060	42
1113.98.22.08	226	1160.50.420	19	1165.84.50.42	162	1180.50.410	93	1300.42.400.135	42
1116.98.08	226	1160.63	19	1165.84.63.54	162	1180.63.460	93	1300.42.420.140	42
1116.98.25.08	226	1160.63.520	19	1180.07.060	95	1180.63.500	93	1300.48.460.140	42
1121.98.30.08	226	1160.75	19	1180.07.075	95	1181.07.060	91	1300.48.465.060	42
1129.98.08	226	1160.75.630	19	1180.08.035	93	1181.07.075	91	1300.50.340.115	40
1136.98.08	226	1165.07	156	1180.08.040	93	1181.09.080	91	1300.50.370.070	40
1145.12.050	178	1165.09	156	1180.09.080	95	1181.09.100	91	1300.50.400.060	40
1145.12.070	178	1165.10	155	1180.09.100	95	1181.11.085	91	1300.50.400.135	40
1145.17.060	178	1165.11	156	1180.09.91.080	97	1181.11.120	91	1300.50.420.140	40
1145.17.100	178	1165.12	155	1180.09.91.100	97	1181.12.060	90	1300.63.460.140	40
1145.20.080	178	1165.13	156	1180.10.040	93	1181.12.075	90	1300.63.465.060	40
1145.20.130	178	1165.16	156	1180.10.060	93	1181.13.110	91	1301.09.090.042	42
1145.25.110	178	1165.17	155	1180.10.91.040	96	1181.13.140	91	1301.13.130.050	42
1145.25.170	178	1165.20	155	1180.10.91.060	96	1181.16.110	91	1301.13.150.050	42
1145.32.150	178	1165.21	156	1180.11.085	95	1181.16.140	91	1301.16.130.050	42
1145.32.210	178	1165.25	155	1180.11.120	95	1181.17.080	90	1301.16.150.050	42
1145.40.230	178	1165.29	156	1180.11.91.085	97	1181.17.100	90	1301.17.090.042	41
1145.40.280	178	1165.32	155	1180.11.91.120	97	1181.20.110	90	1301.20.130.050	41
1145.50.290	178	1165.36	156	1180.12.060	93	1181.20.140	90	1301.20.150.050	41
1145.50.350	178	1165.40	155	1180.12.075	93	1181.21.160	91	1301.21.190.070	42
1145.63.390	178	1165.48	156	1180.12.91.060	96	1181.21.190	91	1301.21.220.060	42
1145.63.480	178	1165.50	155	1180.12.91.075	96	1181.25.160	90	1301.21.220.080	42
1145.63.550	178	1165.63	155	1180.13.110	95	1181.25.190	90	1301.25.190.070	41
1160.06.025	19	1165.80.07.060	161	1180.13.140	95	1181.29.230	91	1301.29.260.070	42
1160.06.030	19	1165.80.07.075	161	1180.13.91.110	97	1181.29.255	91	1301.29.265.090	42
1160.07.065	25	1165.80.09.080	161	1180.13.91.140	97	1181.32.210	90	1301.29.280.060	42
1160.07.075	25	1165.80.09.100	161	1180.16.110	95	1181.32.250	90	1301.29.300.100	42
1160.08.030	19	1165.80.10.040	160	1180.16.140	95	1183.12.050	89	1301.29.320.090	42
1160.08.040	19	1165.80.10.060	160	1180.16.91.110	97	1183.12.065	89	1301.29.330.065	42
1160.09	25	1165.80.11.085	161	1180.16.91.140	97	1183.17	89	1301.32.220.060	41
1160.09.105	25	1165.80.11.120	161	1180.17.080	93	1183.20	89	1301.32.220.080	41
1160.10.040	19	1165.80.12.060	160	1180.17.100	93	1183.25	89	1301.40.260.070	41
1160.10.060	19	1165.80.12.075	160	1180.17.91.080	96	1183.32	89	1301.40.265.090	41
1160.11	25	1165.80.13.110	161	1180.17.91.100	96	13...		1301.40.280.060	41
1160.11.120	25	1165.80.13.140	161	1180.20.110	93	1300.09.090.042	42	1301.40.300.100	41
1160.12.050	19	1165.80.16.110	161	1180.20.140	93	1300.13.130.050	42	1301.40.320.090	41
1160.12.065	19	1165.80.16.140	161	1180.20.91.110	96	1300.13.150.050	42	1301.40.330.065	41
1160.12.075	19	1165.80.17.080	160	1180.20.91.140	96	1300.16.130.050	42	1301.42.340.115	42
1160.13	25	1165.80.17.100	160	1180.21.160	95	1300.16.150.050	42	1301.42.370.070	42
1160.13.145	25	1165.80.20.110	160	1180.21.190	95	1300.17.090.042	40	1301.42.400.060	42
1160.16	25	1165.80.20.140	160	1180.21.91.160	97	1300.20.130.050	40	1301.42.400.135	42
1160.16.145	25	1165.80.21.160	161	1180.21.91.190	97	1300.20.150.050	40	1301.42.420.140	42
1160.17	19	1165.80.21.190	161	1180.25.160	93	1300.21.190.070	42	1301.48.460.140	42
1160.17.105	19	1165.80.25.160	160	1180.25.190	93	1300.21.220.060	42	1301.48.465.060	42
1160.20	19	1165.80.25.190	160	1180.25.91.160	96	1300.21.220.080	42	1301.50.340.115	41
1160.20.145	19	1165.80.29.230	161	1180.25.91.190	96	1300.25.190.070	40	1301.50.370.070	41
1160.21	25	1165.80.29.255	161	1180.29.230	95	1300.29.260.070	42	1301.50.400.060	41

Art.-Nr. Art. No.	Seite Page	Art.-Nr. Art. No.	Seite Page	Art.-Nr. Art. No.	Seite Page	Art.-Nr. Art. No.	Seite Page	Art.-Nr. Art. No.	Seite Page
1301.50.400.135	41	1310.25.2.090	34	1311.25.3.090	35	1540.11	172	1545.07.06	184
1301.50.420.140	41	1310.25.2.100	34	1311.25.4.070	35	1540.11.055	172	1545.09.08	184
1301.63.460.140	41	1310.25.3.070	34	1311.25.6.060	35	1540.11.085	172	1545.11.07	184
1301.63.465.060	41	1310.25.3.090	34	1311.29.3.090	37	1540.11.120	172	1545.11.10	184
1310.020.07	229	1310.25.4.070	34	1311.32.2.115	35	1540.12.050	168	1545.12.06	180
1310.030.07	229	1310.25.6.060	34	1311.32.3.090	35	1540.12.065	168	1545.12.1.06	182
1310.040.07	229	1310.29.3.090	36	1311.32.3.105	35	1540.12.080	168	1545.13.07	184
1310.050.07	229	1310.32.2.115	34	1311.32.4.090	35	1540.13	172	1545.13.12	184
1310.060.07	229	1310.32.3.090	34	1311.32.6.070	35	1540.13.080	172	1545.16.11	184
1310.070.07	229	1310.32.3.105	34	1370.15	77	1540.13.110	172	1545.16.14	184
1310.080.07	229	1310.32.4.090	34	1370.15.30	77	1540.13.150	172	1545.17.06	180
1310.09.2.030	36	1310.32.6.070	34	1370.15.49.04	77	1540.16	172	1545.17.1.06	182
1310.09.2.040	36	1311.09.2.030	37	1370.15.49.45	77	1540.16.080	172	1545.17.1.10	182
1310.09.2.050	36	1311.09.2.040	37	1370.15.63.12	77	1540.16.110	172	1545.17.10	180
1310.090.07	229	1311.09.2.050	37	14...		1540.16.150	172	1545.20.08	180
1310.100.07	229	1311.11.2.050	37	14.582.33	194	1540.17	168	1545.20.1.08	182
1310.11.2.050	36	1311.11.2.060	37	14.582.34	194	1540.17.060	168	1545.20.1.13	182
1310.11.2.060	36	1311.11.2.075	37	14.582.35	194	1540.17.080	168	1545.20.13	180
1310.11.2.075	36	1311.11.3.050	37	14.582.36	194	1540.17.105	168	1545.21.14	184
1310.11.3.050	36	1311.13.2.050	37	14.582.37	194	1540.20	168	1545.21.18	184
1310.110.07	229	1311.13.2.060	37	14.582.38	194	1540.20.080	168	1545.25.1.11	182
1310.120.07	229	1311.13.2.075	37	14.582.39	194	1540.20.110	168	1545.25.1.17	182
1310.13.2.050	36	1311.13.3.050	37	14.582.93	194	1540.20.150	168	1545.25.11	180
1310.13.2.060	36	1311.13.3.060	37	14.582.94	194	1540.21	172	1545.25.17	180
1310.13.2.075	36	1311.13.3.065	37	14.582.95	194	1540.21.125	172	1545.29.25	184
1310.13.3.050	36	1311.13.4.050	37	14.582.96	194	1540.21.160	172	1545.32.1.25	182
1310.13.3.060	36	1311.13.4.060	37	14.582.97	194	1540.21.205	172	1545.32.25	180
1310.13.3.065	36	1311.16.2.050	37	14.582.98	194	1540.25	168	1545.36.33	184
1310.13.4.050	36	1311.16.2.060	37	14.582.99	194	1540.25.125	168	1545.40.1.33	182
1310.13.4.060	36	1311.16.2.075	37	14.583.03	194	1540.25.160	168	1545.42.38	184
1310.16.2.050	36	1311.16.2.090	37	14.583.04	194	1540.25.205	168	1545.48.44	184
1310.16.2.060	36	1311.16.3.050	37	14.583.05	194	1540.29	172	1545.50.1.38	182
1310.16.2.075	36	1311.16.3.060	37	14.583.06	194	1540.29.190	172	1545.63.1.44	182
1310.16.2.090	36	1311.16.3.070	37	14.583.07	194	1540.29.230	172	1545.N0375.08	185
1310.16.3.050	36	1311.16.4.050	37	14.583.08	194	1540.29.275	172	1545.N0500.07	185
1310.16.3.060	36	1311.16.4.060	37	14.583.09	194	1540.32	168	1545.N0500.12	185
1310.16.3.070	36	1311.16.4.070	37	1400.11	44	1540.32.170	168	1545.N0750.14	185
1310.16.4.050	36	1311.17.2.030	35	1400.16	44	1540.32.210	168	1545.N0750.18	185
1310.16.4.060	36	1311.17.2.040	35	1400.17	44	1540.32.255	168	1545.N1000.22	185
1310.16.4.070	36	1311.17.2.050	35	1400.20	44	1540.36	172	1546.07.06	188
1310.17.2.030	34	1311.20.2.050	35	1400.21	44	1540.36.260	172	1546.09.08	188
1310.17.2.040	34	1311.20.2.060	35	1400.25	44	1540.36.305	172	1546.11.07	188
1310.17.2.050	34	1311.20.2.075	35	15...		1540.36.350	172	1546.11.10	188
1310.20.2.050	34	1311.20.3.050	35	1520.11	173	1540.40	168	1546.12.06	186
1310.20.2.060	34	1311.20.3.060	35	1520.16	173	1540.40.240	168	1546.12.1.06	187
1310.20.2.075	34	1311.20.3.065	35	1520.16.080	173	1540.40.285	168	1546.13.07	188
1310.20.3.050	34	1311.20.4.050	35	1520.16.110	173	1540.40.330	168	1546.13.12	188
1310.20.3.060	34	1311.20.4.060	35	1520.17	169	1540.42	172	1546.16.11	188
1310.20.3.065	34	1311.21.2.070	37	1520.20	169	1540.42.330	172	1546.16.14	188
1310.20.4.050	34	1311.21.2.090	37	1520.20.080	169	1540.42.370	172	1546.17.08	186
1310.20.4.060	34	1311.21.2.100	37	1520.20.110	169	1540.42.420	172	1546.17.1.08	187
1310.21.2.070	36	1311.21.2.115	37	1520.25	169	1540.48	172	1546.20.07	186
1310.21.2.090	36	1311.21.3.070	37	1540.07.050	172	1540.48.370	172	1546.20.1.07	187
1310.21.2.100	36	1311.21.3.090	37	1540.07.065	172	1540.48.430	172	1546.20.1.12	187
1310.21.2.115	36	1311.21.3.105	37	1540.07.080	172	1540.48.490	172	1546.20.12	186
1310.21.3.070	36	1311.21.4.070	37	1540.08.035	168	1540.50	168	1546.N0375.08	189
1310.21.3.090	36	1311.21.4.090	37	1540.08.050	168	1540.50.330	168	1546.N0500.07	189
1310.21.3.105	36	1311.21.6.060	37	1540.09	172	1540.50.370	168	1546.N0500.12	189
1310.21.4.070	36	1311.21.6.070	37	1540.09.060	172	1540.50.420	168	1555.07.06	183
1310.21.4.090	36	1311.25.2.070	35	1540.09.080	172	1540.63	168	1555.09.08	183
1310.21.6.060	36	1311.25.2.090	35	1540.09.105	172	1540.63.400	168	1555.11.07	183
1310.21.6.070	36	1311.25.2.100	35	1540.10.040	168	1540.63.460	168	1555.11.10	183
1310.25.2.070	34	1311.25.3.070	35	1540.10.060	168	1540.63.520	168	1555.12.06	180

1
2
3
4
5
6
7
8
9
10
11
12

Suchhilfe

Search help

Art.-Nr. Art. No.	Seite Page	Art.-Nr. Art. No.	Seite Page	Art.-Nr. Art. No.	Seite Page	Art.-Nr. Art. No.	Seite Page	Art.-Nr. Art. No.	Seite Page
1555.12.1.06	181	1556.42.38	183	1571.16.3.050	175	1571.36.350	170	1572.29	171
1555.13.07	183	1556.48.44	183	1571.16.3.060	175	1571.40	166	1572.29.190	171
1555.13.12	183	1556.50.1.38	181	1571.16.3.065	175	1571.40.240	166	1572.29.230	171
1555.16.11	183	1556.63.1.44	181	1571.16.4.050	175	1571.40.285	166	1572.29.275	171
1555.16.14	183	1556.N0375.08	185	1571.16.4.060	175	1571.40.330	166	1572.32	167
1555.17.06	180	1556.N0500.07	185	1571.17	166	1571.42	170	1572.32.170	167
1555.17.1.06	181	1556.N0500.12	185	1571.17.060	166	1571.42.330	170	1572.32.210	167
1555.17.1.10	181	1556.N0750.14	185	1571.17.080	166	1571.42.370	170	1572.32.255	167
1555.17.10	180	1556.N0750.18	185	1571.17.105	166	1571.42.420	170	1572.36	171
1555.20.08	180	1556.N1000.22	185	1571.17.2.030	174	1571.48	170	1572.36.260	171
1555.20.1.08	181	1570.09	173	1571.17.2.040	174	1571.48.370	170	1572.36.305	171
1555.20.1.13	181	1570.11	173	1571.17.2.050	174	1571.48.430	170	1572.36.350	171
1555.20.13	180	1570.13	173	1571.20	166	1571.48.490	170	1572.40	167
1555.21.14	183	1570.16	173	1571.20.080	166	1571.50	166	1572.40.240	167
1555.21.18	183	1570.17	169	1571.20.110	166	1571.50.330	166	1572.40.285	167
1555.25.1.11	181	1570.20	169	1571.20.150	166	1571.50.370	166	1572.40.330	167
1555.25.1.17	181	1570.21	173	1571.20.2.050	174	1571.50.420	166	1572.42	171
1555.25.11	180	1570.25	169	1571.20.2.060	174	1571.63	166	1572.42.330	171
1555.25.17	180	1570.29	173	1571.20.2.075	174	1571.63.400	166	1572.42.370	171
1555.29.25	183	1570.32	169	1571.20.3.050	174	1571.63.460	166	1572.42.420	171
1555.32.1.25	181	1571.07.050	170	1571.20.3.060	174	1571.63.520	166	1572.48	171
1555.32.25	180	1571.07.065	170	1571.20.3.065	174	1572.07.050	171	1572.48.370	171
1555.36.33	183	1571.07.080	170	1571.20.4.050	174	1572.07.065	171	1572.48.430	171
1555.40.1.33	181	1571.08.035	166	1571.20.4.060	174	1572.07.080	171	1572.48.490	171
1555.42.38	183	1571.08.050	166	1571.21	170	1572.08.035	167	1572.50	167
1555.48.44	183	1571.09	170	1571.21.125	170	1572.08.050	167	1572.50.330	167
1555.50.1.38	181	1571.09.060	170	1571.21.160	170	1572.09	171	1572.50.370	167
1555.63.1.44	181	1571.09.080	170	1571.21.2.070	175	1572.09.060	171	1572.50.420	167
1555.N0375.08	185	1571.09.105	170	1571.21.2.090	175	1572.09.080	171	1572.63	167
1555.N0500.07	185	1571.09.2.030	175	1571.21.2.100	175	1572.09.105	171	1572.63.400	167
1555.N0500.12	185	1571.09.2.040	175	1571.21.2.205	170	1572.10.040	167	1572.63.460	167
1555.N0750.14	185	1571.09.2.050	175	1571.21.3.070	175	1572.10.060	167	1572.63.520	167
1555.N0750.18	185	1571.10.040	166	1571.21.3.090	175	1572.11	171	1576.07.06	188
1555.N1000.22	185	1571.10.060	166	1571.21.4.070	175	1572.11.055	171	1576.09.08	188
1556.07.06	183	1571.11	170	1571.21.6.060	175	1572.11.085	171	1576.11.07	188
1556.09.08	183	1571.11.055	170	1571.25	166	1572.11.120	171	1576.11.10	188
1556.11.07	183	1571.11.085	170	1571.25.125	166	1572.12.050	167	1576.12.06	186
1556.11.10	183	1571.11.120	170	1571.25.160	166	1572.12.065	167	1576.12.1.06	187
1556.12.06	180	1571.11.2.050	175	1571.25.2.070	174	1572.12.080	167	1576.13.07	188
1556.12.1.06	181	1571.11.2.060	175	1571.25.2.090	174	1572.13	171	1576.13.12	188
1556.13.07	183	1571.11.3.050	175	1571.25.2.100	174	1572.13.080	171	1576.16.11	188
1556.13.12	183	1571.12.050	166	1571.25.205	166	1572.13.110	171	1576.16.14	188
1556.16.11	183	1571.12.065	166	1571.25.3.070	174	1572.13.150	171	1576.17.08	186
1556.16.14	183	1571.12.080	166	1571.25.3.090	174	1572.16	171	1576.17.1.08	187
1556.17.06	180	1571.13	170	1571.25.4.070	174	1572.16.080	171	1576.20.07	186
1556.17.1.06	181	1571.13.080	170	1571.25.6.060	174	1572.16.110	171	1576.20.1.07	187
1556.17.1.10	181	1571.13.110	170	1571.29	170	1572.16.150	171	1576.20.1.12	187
1556.17.10	180	1571.13.150	170	1571.29.190	170	1572.17	167	1576.20.12	186
1556.20.08	180	1571.13.2.050	175	1571.29.230	170	1572.17.060	167	1576.N0375.08	189
1556.20.1.08	181	1571.13.2.060	175	1571.29.275	170	1572.17.080	167	1576.N0500.07	189
1556.20.1.13	181	1571.13.2.075	175	1571.29.3.090	175	1572.17.105	167	1576.N0500.12	189
1556.20.13	180	1571.13.3.050	175	1571.32	166	1572.20	167	1577.07.06	188
1556.21.14	183	1571.13.3.060	175	1571.32.170	166	1572.20.080	167	1577.09.08	188
1556.21.18	183	1571.13.3.065	175	1571.32.2.115	174	1572.20.110	167	1577.11.07	188
1556.25.1.11	181	1571.13.4.050	175	1571.32.210	166	1572.20.150	167	1577.11.10	188
1556.25.1.17	181	1571.13.4.060	175	1571.32.255	166	1572.21	171	1577.12.06	186
1556.25.11	180	1571.16	170	1571.32.3.090	174	1572.21.125	171	1577.12.1.06	187
1556.25.17	180	1571.16.080	170	1571.32.3.105	174	1572.21.160	171	1577.13.07	188
1556.29.25	183	1571.16.110	170	1571.32.4.090	174	1572.21.205	171	1577.13.12	188
1556.32.1.25	181	1571.16.150	170	1571.32.6.070	174	1572.25	167	1577.16.11	188
1556.32.25	180	1571.16.2.050	175	1571.36	170	1572.25.125	167	1577.16.14	188
1556.36.33	183	1571.16.2.060	175	1571.36.260	170	1572.25.160	167	1577.17.08	186
1556.40.1.33	181	1571.16.2.075	175	1571.36.305	170	1572.25.205	167	1577.17.1.08	187

Art.-Nr. Art. No.	Seite Page	Art.-Nr. Art. No.	Seite Page	Art.-Nr. Art. No.	Seite Page	Art.-Nr. Art. No.	Seite Page	Art.-Nr. Art. No.	Seite Page
1577.20.07	186	1710.60.20.1/2	153	1710.80.48.465.1	159	1800.36.13.350	51	1807.02	53
1577.20.1.07	187	1710.60.20.17	153	1710.80.50.370.1	157	1800.40.03.330	48	1809.02	53
1577.20.1.12	187	1710.60.20.19	153	1710.80.50.410.1	157	1800.40.13.330	49	1809.26	116
1577.20.12	186	1710.60.20.21	153	1710.80.63.460.1	157	1800.42.03.410	50	1809.26.50	120
1577.N0375.08	189	1710.60.20.3/8	153	1710.80.63.460.2	158	1800.42.13.410	51	181/2G.11.26	116
1577.N0500.07	189	1710.60.21.27	154	1710.80.63.500.1	157	1800.48.03.490	50	181/2G.16.26	116
1577.N0500.12	189	1710.60.25.21	153	1710.80.63.500.2	158	1800.48.13.490	51	181/2NPT.11.26	117
16...		1710.60.25.27	153	18...		1800.50.03.410	48	181/2NPT.16.26	117
1600.17	195	1710.60.25.3/4	153	1800.07.03.065	50	1800.50.13.410	49	1811.02	53
1600.20	195	1710.60.29.36	154	1800.07.03.080	50	1800.63.03.520	48	1811.26	116
1600.25	195	1710.60.32.1	153	1800.07.13.065	51	1800.63.13.520	49	1811.26.50	120
1600.32	195	1710.60.32.27	153	1800.07.13.080	51	1800.75.03.630	48	1811/2G.36.26	116
1600.40	195	1710.60.36.45	154	1800.09.03.105	50	1800.75.13.630	49	1811/2NPT.36.26	117
1600.50	195	1710.60.40.11/4	153	1800.09.13.105	51	1801.09	81	1811/2NPT.36.27	117
1600.63	195	1710.60.40.36	153	1800.10.03.040	48	1801.10.09	57	1811/4G.29.27	116
1620.17	195	1710.60.42.45	154	1800.10.03.060	48	1801.10.11	57	1811/4NPT.29.26	117
1620.20	195	1710.60.48.56	154	1800.10.09	55	1801.10.13	57	1811/4NPT.29.27	117
1620.25	195	1710.60.50.45	153	1800.10.11	55	1801.10.16	57	1812.02	52
1620.32	195	1710.60.63.2	153	1800.10.13	55	1801.10.17	56	1813.02	53
1620.40	195	1710.60.63.56	153	1800.10.13.040	49	1801.10.20	56	1813.26	116
1620.50	195	1710.80.07.060.1	159	1800.10.13.060	49	1801.10.21	57	1816.02	53
1620.63	195	1710.80.09.080.1	159	1800.10.16	55	1801.10.25	56	1816.26	116
17...		1710.80.09.100.1	159	1800.10.17	54	1801.10.29	57	1816.26.50	120
1700.07.10	154	1710.80.11.085.1	159	1800.10.20	54	1801.10.32	56	1817.02	52
1700.09.14	154	1710.80.11.120.1	159	1800.10.21	55	1801.10.40	56	1817.09.26	115
1700.11.14	154	1710.80.12.060.1	157	1800.10.25	54	1801.11	81	181G.29.26	116
1700.11.17	154	1710.80.12.060.2	158	1800.10.29	55	1801.11.09	57	181NPT.21.26	117
1700.12.1/4	152	1710.80.13.110.1	159	1800.10.32	54	1801.11.11	57	181NPT.21.27	117
1700.12.10	152	1710.80.13.140.1	159	1800.10.40	54	1801.11.13	57	1820.02	52
1700.13.19	154	1710.80.16.110.1	159	1800.11.03.120	50	1801.11.16	57	1820.11.26	115
1700.16.17	154	1710.80.16.140.1	159	1800.11.09	55	1801.11.17	56	1820.16.26	115
1700.16.21	154	1710.80.17.080.1	157	1800.11.11	55	1801.11.20	56	1821.02	53
1700.17.14	152	1710.80.17.080.2	158	1800.11.13	55	1801.11.21	57	1821.26	116
1700.20.1/2	152	1710.80.17.100.1	157	1800.11.13.120	51	1801.11.25	56	1821.26.50	120
1700.20.17	152	1710.80.17.100.2	158	1800.11.16	55	1801.11.29	57	1821.27	116
1700.20.19	152	1710.80.20.110.1	157	1800.11.17	54	1801.11.32	56	1821.27.50	120
1700.20.21	152	1710.80.20.110.2	157	1800.11.20	54	1801.11.40	56	1825.02	52
1700.20.3/8	152	1710.80.20.110.3	158	1800.11.21	55	1801.13	81	1825.21.26	115
1700.21.27	154	1710.80.20.110.4	158	1800.11.25	54	1801.16	81	1825.21.27	115
1700.25.21	152	1710.80.20.140.1	157	1800.11.29	55	1801.17	81	1829.02	53
1700.25.27	152	1710.80.20.140.2	157	1800.11.32	54	1801.20.10	81	1829.26	116
1700.25.3/4	152	1710.80.20.140.4	158	1800.11.40	54	1801.20.12	81	1829.26.50	120
1700.29.36	154	1710.80.21.160.1	159	1800.12.03.065	48	1801.20.14	81	1829.27	116
1700.32.1	152	1710.80.21.190.1	159	1800.12.03.080	48	1801.21	81	183/4G.21.26	116
1700.32.27	152	1710.80.25.160.1	157	1800.12.13.065	49	1801.25	81	183/4G.21.27	116
1700.36.45	154	1710.80.25.160.2	158	1800.12.13.080	49	1801.29	81	183/4NPT.11.26	117
1700.40.11/4	152	1710.80.25.190.1	157	1800.13.03.150	50	1801.32	81	183/4NPT.16.26	117
1700.40.36	152	1710.80.25.190.2	158	1800.13.13.150	51	1803.07	80	183/4NPT.21.26	117
1700.42.45	154	1710.80.29.230.1	159	1800.16.03.150	50	1803.09	80	183/8G.09.26	116
1700.48.56	154	1710.80.29.255.1	159	1800.16.13.150	51	1803.11	80	183/8NPT.09.26	117
1700.50.45	152	1710.80.32.210.1	157	1800.17.03.105	48	1803.12	80	1832.02	52
1700.63.2	152	1710.80.32.210.2	158	1800.17.13.105	49	1803.13	80	1832.29.26	115
1700.63.56	152	1710.80.32.250.1	157	1800.20.03.150	48	1803.16	80	1836.02	53
1710.60.07.10	154	1710.80.32.250.2	158	1800.20.13.150	49	1803.17	80	1836.26	116
1710.60.09.14	154	1710.80.36.305.1	159	1800.21.03.205	50	1803.20	80	1836.27	116
1710.60.11.14	154	1710.80.36.350.1	159	1800.21.13.205	51	1803.21	80	1840.02	52
1710.60.11.17	154	1710.80.40.285.1	157	1800.25.03.205	48	1803.25	80	1840.29.27	115
1710.60.12.1/4	153	1710.80.40.285.2	158	1800.25.13.205	49	1803.29	80	1848.26	116
1710.60.12.10	153	1710.80.40.320.1	157	1800.29.03.275	50	1803.32	80	1848.27	116
1710.60.13.19	154	1710.80.40.320.2	158	1800.29.13.275	51	1803.36	80	1848.48.26	116
1710.60.16.17	154	1710.80.42.370.1	159	1800.32.03.255	48	1803.40	80	1848.48.27	116
1710.60.16.21	154	1710.80.42.410.1	159	1800.32.13.255	49	1803.42	80	1850.36.26	115
1710.60.17.14	153	1710.80.48.430.1	159	1800.36.03.350	50	1803.48.48	80	1850.36.27	115

Art.-Nr. Art. No.	Seite Page	Art.-Nr. Art. No.	Seite Page	Art.-Nr. Art. No.	Seite Page	Art.-Nr. Art. No.	Seite Page	Art.-Nr. Art. No.	Seite Page
1852.07.05	83	2450.17.34	199	3500.10.06	207	35133/8G	214	3600.13.20	213
1852.09.07	83	2450.17.36	200	3500.10.08	207	3516.09	208	3600.13.25	213
1852.11.07	83	2450.20.32	199	3500.11.06	212	3516.11	208	3600.16.25	213
1852.11.09	83	2450.20.34	199	3500.11.08	212	3516.13	208	3600.16.32	213
1852.12.05	82	2450.20.36	200	3500.11.10	212	351G.21	214	3600.17.11	211
1852.13.09	83	34...		3500.11.12	212	351NPT.16	215	3600.17.20	209
1852.13.11	83	3409.07	216	3500.11.17	212	3521.11	208	3600.20.13	211
1852.13.13	83	3411.07	216	3500.12.08	207	3521.13	208	3600.20.16	211
1852.16.07	82	3411.09	216	3500.12.10	207	3521.16	208	3600.20.25	209
1852.16.13	83	3413.09	216	3500.13.12	212	3529.13	208	3600.21.32	213
1852.16.15	83	3413.11	216	3500.13.17	212	3529.16	208	3600.21.40	213
1852.20.07	82	3416.09	216	3500.16.12	212	3529.21	208	3600.25.21	211
1852.20.09	82	3416.11	216	3500.16.17	212	352G.36	214	3600.25.32	209
1852.20.11	82	3416.13	216	3500.16.20	212	352G.42	214	3600.29.40	213
1852.20.13	82	3417.09	218	3500.17.07	211	353/4G.09	214	3600.29.50	213
1852.20.15	82	3420.11	218	3500.17.10	207	353/4G.11	214	3600.32.29	211
1852.21.15	83	3421.13	216	3500.17.12	207	353/4G.16	214	3600.32.40	209
1852.21.17	83	3421.16	216	3500.20.07	211	353/4NPT.11	215	3600.36.50	213
1852.21.19	83	3425.16	218	3500.20.09	211	353/4NPT.13	215	3600.36.63	213
1852.21.20	83	3429.21	216	3500.20.11	211	353/8G.07	214	3600.40.36	211
1852.25.15	82	3436.29	216	3500.20.12	207	3536.21	208	3600.40.50	209
1852.25.17	82	3440.29	218	3500.20.17	207	3536.29	208	3600.42.63	213
1852.25.19	82	3450.36	218	3500.21.17	212	3542.29	208	3600.42.75	213
1852.25.20	82	3455.09.12	219	3500.21.20	212	3542.36	208	3600.48.63	213
1852.29.20	83	3455.11.17	219	3500.21.25	212	3545.11.17	213	3600.48.75	213
1852.29.23	83	3455.13.17	219	3500.25.09	211	3545.16.20	213	3600.50.42	211
1852.29.25	83	3455.13.20	219	3500.25.11	211	3545.17.12	207	3600.50.48	211
1852.32.23	82	3455.16.20	219	3500.25.13	211	3545.20.12	207	3600.50.63	209
1852.32.25	82	3455.17.12	216	3500.25.16	211	3545.20.17	207	3600.63.75	209
1852.36.26	83	3455.20.12	216	3500.25.17	207	3545.21.20	213	3607.09.08	210
1852.36.30	83	3455.20.17	216	3500.25.20	207	3545.21.25	213	3609.11.08	210
1852.36.33	83	3455.21.25	219	3500.29.25	212	3545.25.17	207	3609.13.08	210
1852.36.35	83	3455.25.12	216	3500.29.32	212	3545.25.20	207	361/2G.11.08	215
1852.40.26	82	3455.25.17	216	3500.32.20	207	3545.29.25	213	361/2G.13.08	215
1852.40.30	82	3455.25.20	216	3500.32.21	211	3545.29.32	213	361/2G.16.08	215
1852.40.33	82	3455.29.32	219	3500.32.25	207	3545.32.20	207	361/2NPT.11	215
1852.40.35	82	3455.32.12	216	3500.36.32	212	3545.32.25	207	361/2NPT.13	215
1852.42.35	83	3455.32.17	216	3500.36.40	212	3545.36.40	213	361/2NPT.16	215
1852.42.38	83	3455.32.20	216	3500.40.25	207	3545.40.25	207	3611.13.08	210
1852.42.40	83	3455.32.25	216	3500.40.29	211	3545.40.32	207	3611.16.08	210
1852.48.48.40	83	3455.36.40	219	3500.40.32	207	3545.50.32	207	3611.21.08	210
1852.48.48.44	83	3455.40.17	216	3500.42.32	212	3545.50.40	207	3611/2G.36.08	215
1863.48.26	115	3455.40.20	216	3500.42.40	212	3545.63.40	207	3613.16.08	210
1863.48.27	115	3455.40.25	216	3500.42.50	212	3545.63.50	207	3613.21.08	210
21...		3455.40.32	216	3500.48.40	212	3548.48.36	208	3616.21.08	210
2111.00.08	226	3455.50.20	216	3500.48.50	212	36...		3616.29.08	210
2111.98.08	226	3455.50.25	216	3500.50.29	211	3600.06.08	209	36161/2G.08	214
24...		3455.50.32	216	3500.50.32	207	3600.06.10	209	361G.29.08	215
2410.17	201	3455.50.40	216	3500.50.40	207	3600.07.12	213	3621.29.08	210
2410.20	201	3455.63.25	216	3500.63.36	211	3600.07.17	213	36213/4G.08	214
2410.25	201	3455.63.32	216	3500.63.40	207	3600.08.10	209	3629.36.08	210
2410.32	201	3455.63.40	216	3500.63.50	207	3600.08.12	209	363/4G.21.08	215
2410.40	201	3455.63.50	216	3500.75.50	207	3600.09.17	213	363/4NPT.21	215
2410.50	201	3463.48	218	3500.75.63	207	3600.09.20	213	363/8G.11.08	215
2445.12	198	35...		3509.07	208	3600.10.07	211	3636.42.08	210
2450.07.32	200	3500.07.06	212	351/2G.09	214	3600.10.09	211	3636.48.08	214
2450.07.34	199	3500.07.08	212	351/2NPT.09	215	3600.10.12	209	3636.48.48.08	210
2450.11.32	200	3500.07.10	212	3511.07	208	3600.10.17	209	3642.48.08	214
2450.11.34	199	3500.08.06	207	3511.09	208	3600.11.20	213	3645.07.12	214
2450.12.32	199	3500.09.06	212	3511/4G.29	214	3600.11.25	213	3645.09.17	214
2450.12.34	199	3500.09.08	212	3513.07	208	3600.12.09	211	3645.11.20	214
2450.12.36	200	3500.09.10	212	3513.09	208	3600.12.17	209	3645.12.17	209
2450.17.32	199	3500.09.12	212	3513.11	208	3600.12.20	209	3645.13.20	214

Art.-Nr. Art. No.	Seite Page	Art.-Nr. Art. No.	Seite Page	Art.-Nr. Art. No.	Seite Page	Art.-Nr. Art. No.	Seite Page	Art.-Nr. Art. No.	Seite Page
3645.16.25	214	5030.013.019	163	5215.17.95	192	5613	74	6875.70.36	232
3645.17.20	209	5030.013.021	163	5215.20	72	5616	74	6875.70.50	232
3645.20.25	209	5030.013.027	163	5215.20.105	192	5617	74	6878.40.06	234
3645.21.32	214	5030.013.036	163	5215.20.13	192	5620	74	6878.40.09	234
3645.25.32	209	5030.013.045	163	5215.20.40.105	192	5621	74	6878.40.13	234
3645.29.40	214	5030.013.056	163	5215.20.40.13	192	5625	74	6878.40.19	234
3645.32.40	209	5031.034.007	163	5215.21	73	5629	74	6878.40.25	234
3645.40.50	209	5031.034.009	163	5215.25	72	5632	74	6878.40.32	234
3645.50.63	209	5031.034.011	163	5215.25.155	192	5636	74	6878.40.38	234
365/8G.16.08	215	5031.034.013	163	5215.25.40.155	192	5640	74	6878.40.50	234
367/8G.29.08	215	5031.034.016	163	5215.29	73	5650	74	80...	
37..		5031.034.021	163	5215.32	72	5711	75	8000.06	202
3707.09	217	5031.034.029	163	5215.40	72	5716	75	8000.06.1	202
3709.11	217	5031.034.036	163	55...		5717	75	8000.08	202
3711.13	217	5031.034.048	163	5500.20.17	193	5720	75	8000.08.1	202
3712.09	218	52...		5500.20.20	193	5721	75	8000.080	202
3713.16	217	5200.07	71	5500.20.25	193	5725	75	8000.085	202
3716.21	217	5200.09	71	5500.20.32	193	5729	75	8000.095	202
3720.13	218	5200.11	71	5500.20.40	193	5732	75	8000.10	202
3720.16	218	5200.12	70	5500.20.50	193	68...		8000.10.1	202
3721.29	217	5200.13	71	5500.40.17	193	6850.40.03	233	8000.100	202
3725.21	218	5200.16	71	5500.40.20	193	6850.40.04	233	8000.105	202
3729.36	217	5200.17	70	5500.40.25	193	6850.40.05	233	8000.115	202
3732.29	218	5200.20	70	5500.40.32	193	6850.40.06	233	8000.12	202
3736.42	217	5200.21	71	5500.40.40	193	6850.40.08	233	8000.17	202
3742.48	217	5200.25	70	5500.40.50	193	6850.40.10	233	8000.20	202
3750.42	218	5200.29	71	5509	76	6850.40.12	233	8000.25	202
3755.07.12	219	5200.32	70	5513	76	6850.40.14	233	8000.32	202
3755.07.17	219	5200.40	70	5516	76	6850.40.16	233	8000.40	202
3755.09.17	219	5210.07	71	5516.10	76	6850.40.18	233	8000.50	202
3755.09.20	219	5210.09	71	5516.12	76	6850.40.20	233	8000.63	202
3755.11.20	219	5210.11	71	5516.13	76	6850.40.22	233	8000.75	202
3755.12.17	217	5210.12	70	5517	76	6850.40.24	233	8007	202
3755.13.25	219	5210.13	71	5520	76	6850.40.25	233	8007.85	102
3755.16.25	219	5210.16	71	5520.11	193	6850.40.30	233	8007.96	204
3755.17.20	217	5210.17	70	5520.16	193	6850.40.35	233	8008.85	102
3755.20.25	217	5210.20	70	5520.21	193	6850.40.40	233	8008.96	204
3755.21.32	219	5210.21	71	5520.29	193	6850.40.45	233	8008.98	204
3755.25.32	217	5210.25	70	5520.36	193	6850.40.50	233	8009	202
3755.29.40	219	5210.29	71	5520.48.48	193	6850.40.70	233	8009.85	102
3755.32.40	217	5210.32	70	5521	76	6875.40.03	232	8009.96	204
3755.40.50	217	5210.40	70	5521.10	76	6875.40.04	232	801/2G	202
3755.42.50	219	5215.07	73	5525	76	6875.40.05	232	8010.85	102
3755.48.63	219	5215.09	73	5529	76	6875.40.05.10	232	8010.96	204
3755.50.63	217	5215.09.65	192	5529.10	76	6875.40.08	232	8010.98	204
48...		5215.09.95	192	5532	76	6875.40.10	232	8011	202
4800.24	230	5215.11	73	5536	76	6875.40.10.10	232	8011.85	102
4800.36	230	5215.11.105	192	5536.10	76	6875.40.15	232	8011.96	204
50...		5215.11.65	192	5540	76	6875.40.18.06	232	8011/2G	202
5000.17.50	201	5215.11.95	192	5540.11	193	6875.40.20	232	8011/4G	202
5000.20.50	201	5215.12	72	5540.16	193	6875.40.24	232	8012.85	102
5000.25.50	201	5215.13	73	5540.21	193	6875.40.30.06	232	8012.96	204
5000.32.50	201	5215.13.105	192	5540.29	193	6875.40.36	232	8012.98	204
5009.50	201	5215.13.13	192	5540.36	193	6875.40.50	232	8013	202
5011.50	201	5215.13.95	192	5540.48.48	193	6875.70.03	232	8013.85	102
5013.50	201	5215.16	73	5550	76	6875.70.04	232	8013.96	204
5016.50	201	5215.16.105	192	5563	76	6875.70.05	232	8016	202
5021.50	201	5215.16.13	192	56...		6875.70.08	232	8016.85	102
5029.50	201	5215.16.155	192	5607	74	6875.70.10	232	8016.96	204
5030.013.010	163	5215.16.95	192	5609	74	6875.70.15	232	8017.85	102
5030.013.014	163	5215.17	72	5611	74	6875.70.20	232	8017.96	204
5030.013.017	163	5215.17.40.95	192	5612	74	6875.70.24	232	8017.98	204

Art.-Nr. Art. No.	Seite Page	Art.-Nr. Art. No.	Seite Page	Art.-Nr. Art. No.	Seite Page	Art.-Nr. Art. No.	Seite Page	Art.-Nr. Art. No.	Seite Page
801G	202	8236	205	8300.32.1	203	8721.08	221	8841.07	149
8020.85	102	8236.40	205	8300.40	203	8721.11.08	221	8841.09	149
8020.96	204	8240	205	8300.40.1	203	8725.08	220	8841.11	149
8020.98	204	8240.40	205	8300.50.1	203	8725.11.08	220	8841.12	149
8021	202	8242	205	8300.63.1	203	8725.96.08	223	8841.13	149
8021.85	102	8242.40	205	8324.12	200	8725.96.08.70	222	8841.16	149
8021.96	204	8245.07	206	8324.17	200	8725.96.11.08	223	8841.17	149
8025.85	102	8245.09	206	8324.20	200	8725.96.11.08.70	222	8841.20	149
8025.96	204	8245.11	206	87...		8729.08	221	8841.21	149
8025.98	204	8245.12	206	8706.08	220	8729.11.08	221	8841.25	149
8029	202	8245.13	206	8706.11.08	220	8732.08	220	8841.29	149
8029.85	102	8245.16	206	8707.08	221	8732.11.08	220	8841.32	149
8029.96	204	8245.17	206	8707.11.08	221	8732.96.08	223	8841.36	149
803/4G	202	8245.20	206	8708.08	220	8732.96.08.70	222	8841.40	149
803/8G	202	8245.21	206	8708.11.08	220	8732.96.11.08	223	8841.42	149
8032.85	102	8245.25	206	8709.08	221	8732.96.11.08.70	222	8841.48	149
8032.96	204	8245.29	206	8709.11.08	221	8736.08	221	8841.50	149
8032.98	204	8245.32	206	8710.07	119	8736.11.08	221	8841.63	149
8036	202	8245.36	206	8710.08	220	8740.08	220	8842	224
8036.85	102	8245.40	206	8710.09	119	8740.11.08	220	8845.12	224
8036.96	204	8245.42	206	8710.11	119	8740.96.08	223	8845.17	224
8040.85	102	8245.48	206	8710.11.08	220	8740.96.08.70	222	8845.20	224
8040.96	204	8245.50	206	8710.12	119	8740.96.11.08	223	8845.25	224
8040.98	204	8245.63	206	8710.13	119	8740.96.11.08.70	222	8845.32	224
8042	202	8248.48	205	8710.16	119	8742.08	221	8845.40	224
8042.85	102	8248.48.40	205	8710.17	119	8745.12	221	8845.50	224
8048	202	8250	205	8710.20	119	8745.17	221	8845.63	224
8048.48	202	8250.40	205	8710.21	119	8745.20	221	8848.48	224
8048.85	102	8255.07	206	8710.25	119	8745.25	221	8855.12	224
805/8G	202	8255.09	206	8710.29	119	8745.32	221	8855.17	224
8050	202	8255.11	206	8710.32	119	8745.40	221	8855.20	224
8050.85	102	8255.12	206	8710.36	119	8745.50	221	8855.25	224
8050.96	204	8255.13	206	8710.40	119	8745.63	221	8855.32	224
8050.98	204	8255.16	206	8710.50	119	8748.08	221	8855.40	224
8051	202	8255.17	206	8710.63	119	8748.11.08	221	8855.50	224
8063.85	102	8255.20	206	8710.96.08	223	8748.48.08	221	8855.63	224
8063.96	204	8255.21	206	8710.96.08.70	222	8750.08	220	B 1...	
8063.98	204	8255.25	206	8710.96.11.08	223	8750.11.08	220	B 107	79
82...		8255.29	206	8710.96.11.08.70	222	8750.96.08	223	B 107.00.03	228
8207	205	8255.32	206	8711.08	221	8750.96.08.70	222	B 109	79
8207.40	205	8255.36	206	8711.11.08	221	8750.96.11.08	223	B 109.00.03	228
8209	205	8255.40	206	8712.08	220	8750.96.11.08.70	222	B 111	79
8209.40	205	8255.42	206	8712.11.08	220	8763.08	220	B 111.00.03	228
8211	205	8255.48	206	8712.96.08	223	8763.11.08	220	B 112	78
8211.40	205	8255.50	206	8712.96.08.70	222	8763.96.08	223	B 113	79
8212	205	8255.63	206	8712.96.11.08	223	8763.96.08.70	222	B 113.00.03	228
8212.40	205	83...		8712.96.11.08.70	222	8763.96.11.08	223	B 116	79
8213	205	8300.07	203	8713.08	221	8763.96.11.08.70	222	B 116.00.03	228
8213.40	205	8300.09	203	8713.11.08	221	8775.08	220	B 117	78
8216	205	8300.11	203	8716.08	221	8775.11.08	220	B 120.10	78
8216.40	205	8300.12	203	8716.11.08	221	8775.96.08	223	B 120.12	78
8217	205	8300.12.1	203	8717.08	220	8775.96.08.70	222	B 120.14	78
8217.40	205	8300.13	203	8717.11.08	220	8775.96.11.08	223	B 121	79
8220	205	8300.16	203	8717.96.08	223	8775.96.11.08.70	222	B 121.00.03	228
8220.40	205	8300.17	203	8717.96.08.70	222	88...		B 125	78
8221	205	8300.17.1	203	8717.96.11.08	223	8807	224	B 129	79
8221.40	205	8300.20	203	8717.96.11.08.70	222	8809	224	B 129.00.03	228
8225	205	8300.20.1	203	8720.08	220	8811	224	B 132	78
8225.40	205	8300.21	203	8720.11.08	220	8813	224	B 136	79
8229	205	8300.25	203	8720.96.08	223	8816	224	B 136.00.03	228
8229.40	205	8300.25.1	203	8720.96.08.70	222	8821	224	B 140	78
8232	205	8300.29	203	8720.96.11.08	223	8829	224	B 142	79
8232.40	205	8300.32	203	8720.96.11.08.70	222	8836	224	B 142.00.03	228

Art.-Nr. Art. No.	Seite Page	Art.-Nr. Art. No.	Seite Page	Art.-Nr. Art. No.	Seite Page	Art.-Nr. Art. No.	Seite Page	Art.-Nr. Art. No.	Seite Page
B 148.00.03	228	EX1080.10.040	131	EX1100.17.060	121	EX1310.40.2.150	123	EX1540.09.4.015	141
B 148.48	79	EX1080.10.060	131	EX1100.17.080	121	EX1310.40.7.090	123	EX1540.11.055	139
B 150	78	EX1080.11.085	132	EX1100.20.080	121	EX1310.48.3.180	124	EX1540.11.085	139
B 163	78	EX1080.11.120	132	EX1100.20.110	121	EX1310.48.6.120	124	EX1540.11.2.050	141
B 2...		EX1080.12.060	131	EX1100.21.125	122	EX1310.50.4.100	123	EX1540.11.3.030	141
B 209	79	EX1080.12.075	131	EX1100.21.160	122	EX1310.63.3.180	123	EX1540.13.080	139
B 211	79	EX1080.13.110	132	EX1100.25.125	121	EX1310.63.6.120	123	EX1540.13.110	139
B 212	78	EX1080.13.140	132	EX1100.25.160	121	EX15...		EX1540.13.2.050	141
B 213	79	EX1080.16.110	132	EX1100.29.190	122	EX1530.09.060	143	EX1540.13.3.040	141
B 216	79	EX1080.16.140	132	EX1100.29.230	122	EX1530.09.080	143	EX1540.16.080	139
B 217	78	EX1080.17.080	131	EX1100.32.170	121	EX1530.11.055	143	EX1540.16.110	139
B 220.10	78	EX1080.17.100	131	EX1100.32.210	121	EX1530.11.085	143	EX1540.16.3.060	141
B 220.12	78	EX1080.20.110	131	EX1100.36.260	122	EX1530.13.080	143	EX1540.16.6.030	141
B 220.14	78	EX1080.20.140	131	EX1100.36.305	122	EX1530.13.110	143	EX1540.17.060	137
B 221	79	EX1080.21.160	132	EX1100.40.240	121	EX1530.16.080	143	EX1540.17.080	137
B 225	78	EX1080.21.190	132	EX1100.40.285	121	EX1530.16.110	143	EX1540.17.2.030	140
B 229	79	EX1080.25.160	131	EX1126.17.070	118	EX1530.17.060	142	EX1540.17.4.015	140
B 232	78	EX1080.25.190	131	EX1126.17.100	118	EX1530.17.080	142	EX1540.20.080	137
B 236	79	EX1080.29.230	132	EX1126.20.110	118	EX1530.20.080	142	EX1540.20.110	137
B 240	78	EX1080.29.255	132	EX1126.20.140	118	EX1530.20.110	142	EX1540.20.2.050	140
B 242	79	EX1080.32.210	131	EX1126.25.150	118	EX1530.21.125	143	EX1540.20.6.030	140
B 248.48	79	EX1080.36.305	132	EX1126.25.180	118	EX1530.21.160	143	EX1540.21.125	139
B 250	78	EX1080.40.285	131	EX1126.32.230	118	EX1530.21.190	143	EX1540.21.160	139
B 263	78	EX1081.07.060	130	EX1126.32.260	118	EX1530.21.205	143	EX1540.21.190	139
EX10...		EX1081.07.075	130	EX1126.40.260	118	EX1530.25.125	142	EX1540.21.205	139
EX1000.07.065	122	EX1081.09.080	130	EX1126.40.320	118	EX1530.25.160	142	EX1540.21.3.090	141
EX1000.07.080	122	EX1081.09.100	130	EX1126.50.360	118	EX1530.25.190	142	EX1540.21.4.070	141
EX1000.08.035	121	EX1081.11.085	130	EX1126.50.420	118	EX1530.25.205	142	EX1540.25.125	137
EX1000.08.050	121	EX1081.11.120	130	EX1126.63.440	118	EX1530.29.210	143	EX1540.25.160	137
EX1000.09.060	122	EX1081.12.060	130	EX1126.63.500	118	EX1530.29.230	143	EX1540.25.190	137
EX1000.09.080	122	EX1081.12.075	130	EX13...		EX1530.29.250	143	EX1540.25.2.100	140
EX1000.10.040	121	EX1081.13.110	130	EX1310.09.2.030	124	EX1530.29.275	143	EX1540.25.205	137
EX1000.10.060	121	EX1081.13.140	130	EX1310.09.4.015	124	EX1530.32.210	142	EX1540.25.3.090	140
EX1000.11.055	122	EX1081.16.110	130	EX1310.11.2.040	124	EX1530.32.220	142	EX1540.25.4.070	140
EX1000.11.085	122	EX1081.16.140	130	EX1310.11.2.050	124	EX1530.32.230	142	EX1540.25.6.060	140
EX1000.12.065	121	EX1081.17.080	130	EX1310.11.3.030	124	EX1530.32.255	142	EX1540.29.210	139
EX1000.12.080	121	EX1081.17.100	130	EX1310.12.3.010	123	EX1530.36.285	143	EX1540.29.230	139
EX1000.13.080	122	EX1081.20.110	130	EX1310.13.2.050	124	EX1530.36.305	143	EX1540.29.250	139
EX1000.13.110	122	EX1081.20.140	130	EX1310.13.3.040	124	EX1530.36.325	143	EX1540.29.275	139
EX1000.16.080	122	EX1081.21.160	130	EX1310.16.2.060	124	EX1530.36.350	143	EX1540.29.3.090	141
EX1000.16.110	122	EX1081.21.190	130	EX1310.16.3.060	124	EX1530.40.270	142	EX1540.29.6.065	141
EX1000.17.060	121	EX1081.25.160	130	EX1310.16.6.030	124	EX1530.40.285	142	EX1540.32.210	137
EX1000.17.080	121	EX1081.25.190	130	EX1310.16.6.040	124	EX1530.40.300	142	EX1540.32.220	137
EX1000.20.080	121	EX1081.29.230	130	EX1310.17.2.030	123	EX1530.40.330	142	EX1540.32.230	137
EX1000.20.110	121	EX1081.29.255	130	EX1310.17.4.015	123	EX1530.42.350	143	EX1540.32.255	137
EX1000.21.125	122	EX1081.32.210	130	EX1310.20.2.050	123	EX1530.42.370	143	EX1540.32.4.090	140
EX1000.21.160	122	EX11...		EX1310.20.2.075	123	EX1530.42.390	143	EX1540.32.6.070	140
EX1000.25.125	121	EX1100.07.065	122	EX1310.20.3.060	123	EX1530.42.420	143	EX1540.36.2.150	141
EX1000.25.160	121	EX1100.07.080	122	EX1310.20.4.050	123	EX1530.48.430	143	EX1540.36.285	139
EX1000.29.190	122	EX1100.08.035	121	EX1310.20.6.030	123	EX1530.48.450	143	EX1540.36.305	139
EX1000.29.230	122	EX1100.08.050	121	EX1310.21.3.090	124	EX1530.48.470	143	EX1540.36.325	139
EX1000.32.170	121	EX1100.09.060	122	EX1310.21.4.070	124	EX1530.48.490	143	EX1540.36.350	139
EX1000.32.210	121	EX1100.09.080	122	EX1310.25.2.100	123	EX1530.50.350	142	EX1540.36.4.100	141
EX1000.36.260	122	EX1100.10.040	121	EX1310.25.3.070	123	EX1530.50.370	142	EX1540.40.2.150	140
EX1000.36.305	122	EX1100.10.060	121	EX1310.25.3.090	123	EX1530.50.390	142	EX1540.40.270	137
EX1000.40.240	121	EX1100.11.055	122	EX1310.25.4.070	123	EX1530.50.420	142	EX1540.40.285	137
EX1000.40.285	121	EX1100.11.085	122	EX1310.25.6.060	123	EX1530.63.440	142	EX1540.40.300	137
EX1080.07.060	132	EX1100.12.065	121	EX1310.29.3.090	124	EX1530.63.460	142	EX1540.40.330	137
EX1080.07.075	132	EX1100.12.080	121	EX1310.29.6.065	124	EX1530.63.480	142	EX1540.40.7.090	140
EX1080.08.035	131	EX1100.13.080	122	EX1310.32.4.090	123	EX1530.63.520	142	EX1540.42.350	139
EX1080.08.040	131	EX1100.13.110	122	EX1310.32.6.070	123	EX1540.09.060	139	EX1540.42.370	139
EX1080.09.080	132	EX1100.16.080	122	EX1310.36.2.150	124	EX1540.09.080	139	EX1540.42.390	139
EX1080.09.100	132	EX1100.16.110	122	EX1310.36.4.100	124	EX1540.09.2.030	141	EX1540.42.4.100	141

1
2
3
4
5
6
7
8
9
10
11
12

Art.-Nr. Art. No.	Seite Page	Art.-Nr. Art. No.	Seite Page	Art.-Nr. Art. No.	Seite Page	Art.-Nr. Art. No.	Seite Page	Art.-Nr. Art. No.	Seite Page
EX1540.42.420	139	EX1571.32.220	136	EX1801.11	129	EX1803.80.50.410	133	EX3600.09.20	147
EX1540.48.3.180	141	EX1571.32.230	136	EX1801.13	129	EX1803.80.63.460	133	EX3600.10.12	146
EX1540.48.430	139	EX1571.32.255	136	EX1801.16	129	EX1803.80.63.500	133	EX3600.11.20	147
EX1540.48.450	139	EX1571.32.4.090	140	EX1801.17	128	EX1811.09	129	EX3600.11.25	147
EX1540.48.470	139	EX1571.32.6.070	140	EX1801.20	128	EX1811.11	129	EX3600.12.17	146
EX1540.48.490	139	EX1571.36.2.150	141	EX1801.21	129	EX1811.13	129	EX3600.13.20	147
EX1540.48.6.120	141	EX1571.36.285	138	EX1801.25	128	EX1811.16	129	EX3600.13.25	147
EX1540.50.350	137	EX1571.36.305	138	EX1801.29	129	EX1811.17	128	EX3600.16.25	147
EX1540.50.370	137	EX1571.36.325	138	EX1801.32	128	EX1811.20	128	EX3600.16.32	147
EX1540.50.390	137	EX1571.36.350	138	EX1801.40	128	EX1811.21	129	EX3600.17.20	146
EX1540.50.4.100	140	EX1571.36.4.100	141	EX1803.07.03.065	126	EX1811.25	128	EX3600.20.25	146
EX1540.50.420	137	EX1571.40.2.150	140	EX1803.07.03.080	126	EX1811.29	129	EX3600.21.32	147
EX1540.63.3.180	140	EX1571.40.270	136	EX1803.09	127	EX1811.32	128	EX3600.21.40	147
EX1540.63.440	137	EX1571.40.285	136	EX1803.11	127	EX1811.40	128	EX3600.25.32	146
EX1540.63.460	137	EX1571.40.300	136	EX1803.12.03.065	125	EX35...		EX3600.29.40	147
EX1540.63.480	137	EX1571.40.330	136	EX1803.12.03.080	125	EX3500.07.08	145	EX3600.29.50	147
EX1540.63.520	137	EX1571.40.7.090	140	EX1803.13	127	EX3500.07.10	145	EX3600.32.40	146
EX1540.63.6.120	140	EX1571.42.350	138	EX1803.16	127	EX3500.09.08	145	EX3600.36.50	147
EX1571.09.060	138	EX1571.42.370	138	EX1803.17	125	EX3500.09.10	145	EX3600.36.63	147
EX1571.09.080	138	EX1571.42.390	138	EX1803.20	125	EX3500.09.12	145	EX3600.40.50	146
EX1571.09.2.030	141	EX1571.42.4.100	141	EX1803.21	127	EX3500.10.08	144	EX3600.42.63	147
EX1571.09.4.015	141	EX1571.42.420	138	EX1803.25	125	EX3500.11.08	145	EX3600.48.63	147
EX1571.11.055	138	EX1571.48.3.180	141	EX1803.29	127	EX3500.11.10	145	EX3600.50.63	146
EX1571.11.085	138	EX1571.48.430	138	EX1803.32	125	EX3500.11.12	145	EX87...	
EX1571.11.2.050	141	EX1571.48.450	138	EX1803.36	127	EX3500.11.17	145	EX8707.08	148
EX1571.11.3.030	141	EX1571.48.470	138	EX1803.40	125	EX3500.12.08	144	EX8708.08	148
EX1571.13.080	138	EX1571.48.490	138	EX1803.42	127	EX3500.12.10	144	EX8709.08	148
EX1571.13.110	138	EX1571.48.6.120	141	EX1803.48	127	EX3500.13.12	145	EX8710.08	148
EX1571.13.2.050	141	EX1571.50.350	136	EX1803.50	125	EX3500.13.17	145	EX8711.08	148
EX1571.13.3.040	141	EX1571.50.370	136	EX1803.63	125	EX3500.16.12	145	EX8712.08	148
EX1571.16.080	138	EX1571.50.390	136	EX1803.80.07.060	134	EX3500.16.17	145	EX8713.08	148
EX1571.16.110	138	EX1571.50.4.100	140	EX1803.80.07.075	134	EX3500.16.20	145	EX8716.08	148
EX1571.16.3.060	141	EX1571.50.420	136	EX1803.80.09.080	134	EX3500.17.10	144	EX8717.08	148
EX1571.16.6.030	141	EX1571.63.3.180	140	EX1803.80.09.100	134	EX3500.17.12	144	EX8720.08	148
EX1571.17.060	136	EX1571.63.440	136	EX1803.80.11.085	134	EX3500.20.12	144	EX8721.08	148
EX1571.17.080	136	EX1571.63.460	136	EX1803.80.11.120	134	EX3500.20.17	144	EX8725.08	148
EX1571.17.2.030	140	EX1571.63.480	136	EX1803.80.12.060	133	EX3500.21.17	145	EX8729.08	148
EX1571.17.4.015	140	EX1571.63.520	136	EX1803.80.12.075	133	EX3500.21.20	145	EX8732.08	148
EX1571.20.080	136	EX1571.63.6.120	140	EX1803.80.13.110	134	EX3500.21.25	145	EX8736.08	148
EX1571.20.110	136	EX17...		EX1803.80.13.140	134	EX3500.25.17	144	EX8740.08	148
EX1571.20.2.050	140	EX1700.12.10.065	135	EX1803.80.16.110	134	EX3500.25.20	144	EX8748.08	148
EX1571.20.6.030	140	EX1700.17.14.060	135	EX1803.80.16.140	134	EX3500.29.25	145	EX8750.08	148
EX1571.21.125	138	EX1700.17.14.080	135	EX1803.80.17.080	133	EX3500.29.32	145	EX8763.08	148
EX1571.21.160	138	EX1700.17.14.105	135	EX1803.80.17.100	133	EX3500.32.20	144		
EX1571.21.190	138	EX1700.20.17.080	135	EX1803.80.20.110	133	EX3500.32.25	144		
EX1571.21.205	138	EX1700.20.17.110	135	EX1803.80.20.140	133	EX3500.36.32	145		
EX1571.21.3.090	141	EX1700.20.19.080	135	EX1803.80.21.160	134	EX3500.36.40	145		
EX1571.21.4.070	141	EX1700.20.19.110	135	EX1803.80.21.190	134	EX3500.40.25	144		
EX1571.25.125	136	EX1700.20.19.150	135	EX1803.80.25.160	133	EX3500.40.32	144		
EX1571.25.160	136	EX1700.20.21.080	135	EX1803.80.25.190	133	EX3500.42.32	145		
EX1571.25.190	136	EX1700.20.21.110	135	EX1803.80.29.230	134	EX3500.42.40	145		
EX1571.25.2.100	140	EX1700.20.21.150	135	EX1803.80.29.255	134	EX3500.42.50	145		
EX1571.25.205	136	EX1700.25.21.125	135	EX1803.80.32.210	133	EX3500.48.40	145		
EX1571.25.3.090	140	EX1700.25.21.160	135	EX1803.80.32.250	133	EX3500.48.50	145		
EX1571.25.4.070	140	EX1700.25.27.125	135	EX1803.80.36.305	134	EX3500.50.32	144		
EX1571.25.6.060	140	EX1700.25.27.160	135	EX1803.80.36.350	134	EX3500.50.40	144		
EX1571.29.210	138	EX1700.25.27.205	135	EX1803.80.40.285	133	EX3500.63.40	144		
EX1571.29.230	138	EX1700.32.27.210	135	EX1803.80.40.320	133	EX35...			
EX1571.29.250	138	EX1700.40.36.285	135	EX1803.80.42.370	134	EX3500.63.50	144		
EX1571.29.275	138	EX1700.50.45.370	135	EX1803.80.42.410	134	EX3600.07.12	147		
EX1571.29.3.090	141	EX1700.63.56.460	135	EX1803.80.48.430	134	EX3600.07.17	147		
EX1571.29.6.065	141	EX18...		EX1803.80.48.465	134	EX3600.08.10	146		
EX1571.32.210	136	EX1801.09	129	EX1803.80.50.370	133	EX3600.09.17	147		

Anfrage für eine Speziallösung Enquiry for a special solution

Kunden Nr.: Customer No.:	Ansprechpartner: Contact:
Jahresbedarf Menge / Stk.: Annual required volume / pieces:	Rahmen / Laufzeit: Scope / timeframe:
Preisvorstellung: Pricing expectations:		

Abmessungen Kabelverschraubung Cable gland dimensions

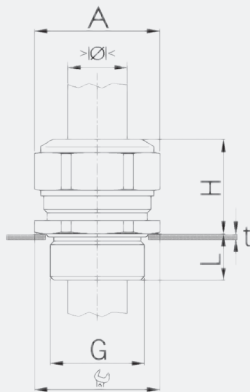

$\varnothing A$	Aussendurchmesser Rosette Outside diameter of rosette mm
G	Anschlussgewinde Entry thread mm
H	Zielhöhe des Bauteils Target height of component mm
L	max. Auftrag in Gerät Max. protrusion in equipment mm
t	Blechdicke Sheet metal thickness mm
	Schlüsselweite Spanner jaw gap mm
$\varnothing k$	Kabelklemmbereich Cable clamping range mm

<input type="checkbox"/> Basis Standard Standard basis	<input type="checkbox"/> Für Innenmontage For interior assembly
---	--

Materialanforderungen Gehäuse Material requirements: enclosure

<input type="checkbox"/> Messing vernickelt (Standard) Nickel-plated brass (standard)	<input type="checkbox"/> Rostfreier Stahl A2 Stainless steel A2
<input type="checkbox"/> Säurebeständiger Stahl A4 Acid-resistant stainless steel A4	<input type="checkbox"/> Andere Others

Materialanforderungen Dichteinsatz Material requirements: sealing insert

<input type="checkbox"/> TPE	<input type="checkbox"/> NBR
<input type="checkbox"/> FPM	<input type="checkbox"/> Multi-Dichteinsatz Multi sealing insert
<input type="checkbox"/> Mit Schlauchanbindung With conduit connection	<input type="checkbox"/> Andere Others

Besondere Bedingungen Special conditions

<input type="checkbox"/> Einsatzgebiet: z.B. Lebensmittel, Pharma, Bahn etc. Where used: e.g. foodstuffs, pharmaceuticals, railway
<input type="checkbox"/> IP-Schutzgrad / Druck / Zeit IP protection class rating / pressure / time / /
<input type="checkbox"/> Temperaturbereich Temperature range - °C + °C
<input type="checkbox"/> Medienbeständigkeit / gasförmig / flüssig Resistance to chemical substances / gaseous / fluid
<input type="checkbox"/> Strahlungsbeständigkeit Radiation resistance
<input type="checkbox"/> Ex-Anforderungen (Einsatz Ex i, Ex e II, Ex d II C) Hazardous area requirements (Ex i, Ex e II, Ex d II C)
<input type="checkbox"/> EMV EMC
<input type="checkbox"/> Normative Anforderungen Requirements from standards

Systeme und Lösungen für die professionelle Elektro-Installation.

Systems und solutions for the professional electrical installation.



Kabelverschraubungen
Cable glands



Kabelschutzschläuche
Protective cable conduits



Elektro-Installation
Electrical installation



Energieeffizienz
Energy efficiency



Brandschutz
Fire protection



Schallschutz
Sound insulation



Strahlenschutz
Radiation protection



Android APP
deutsch



Android APP
english



iOS APP
deutsch



iOS APP
english

Alle weiterführenden Informationen zu Produkten, Systemlösungen und Kommunikationsmedien finden Sie aktuell auf: www.agro.ch.

Please find additional information about products, system solutions and communication media on: www.agro.ch.

AGRO AG | A KAISER COMPANY

Korbackerweg 7 · CH-5502 Hunzenschwil
Tel. +41(0)62 889 47 47 · Fax +41(0)62 889 47 50
www.agro.ch · info@agro.ch

... your quality-connection